



WILLOWBROOK

Manufacturers of Premium Educational Furniture & Soft Seating



Tel: 01780 721115

Furniture Catalogue

www.willowbrookeducation.co.uk

Folio Premium Library Units

Folio Library



Pages 83-90



KubbyKurve

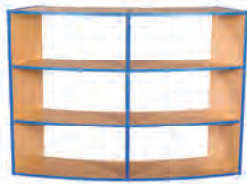

Pages 91-94

Book Trolleys



Pages 79-80

Brittania Bookcases



Pages 77-78

Study Carrels



Pages 81-82

Accento Library



Pages 99-102



Colore! Library



Page 95-98



Shallow Trays



Deep Trays



Extra Deep



Jumbo Trays



All tray units: Pages 105-144

Certwood Crystal Clear Trays

Pages 153-160



Combination



Tall Cupboards



Pages 149-152

A3 Trays



Page 145

Cubby Trays



Pages 105-106

Plan Chests



Page 167-176

Mobile Paper Storage



A1 Paper Storage



A2 Paper Storage



Lockers



Pages 55-56

Coat Stations



Page 58

Lunchbox Trolleys



Page 61

Cloakroom Stations



Pages 69-76

Coat Rails



Page 53

Bag Storage



Page 60

Uniform Storage



Page 59

Benches - Seats



Pages 65-68

Coffee Tables



Pages 31-32

Wall File Storage



Pages 33-34

Wall Pigeonholes



Pages 35-36

Office Organisers



Pages 47-50

Pigeonholes



Pages 39-46

File Storage



Pages 51-54

Cupboards



Pages 161-166

Desks



Page 18

Tables



Pages 19-21

Learning & Storage Walls



Pages 9-16

MakerTeam Activity Units



Pages 27-30

Utile Whiteboard Table



Pages 25-26

Shaped Tables



Page 22

Kubbyclass® Library Units

Bookcases



Pages 179-182
Pages 197-200

Carousels



Pages 196

Curved Bookcases



Pages 185, 186, 203

Reading Nooks



Pages 183-184
Pages 201-202

Book Staircases



Page 195

Book Browsers



Pages 188, 204

Library Sets



Pages 187, 191-194

Kubbyclass® Storage

Shallow Trays



X2 Trays



X3 Trays



X4 Trays



Pages 205-212

Teacher Laptop Station



Page 220

Cupboards



Pages 214-215

Kubbyclass® Cloakroom

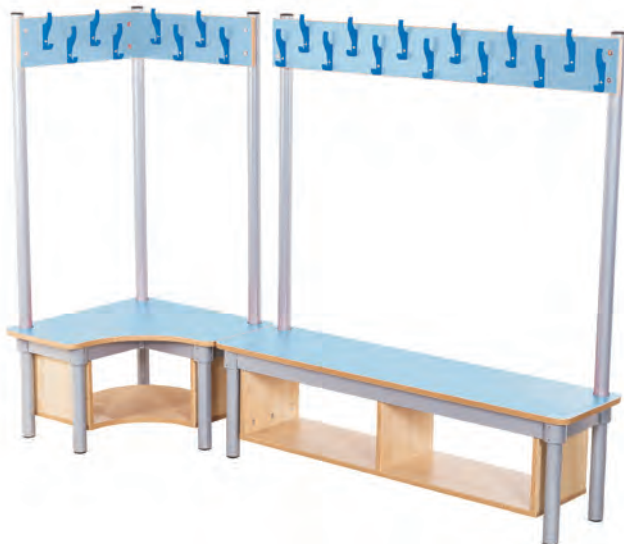

Pages 223-227



Page 228



Pages 221-222

Kubbyclass® Tables & Benches

A large range of table top shapes.



Pages 229-240



Kubbyclass® Early Years

Pages 241-256



Acorn Soft Furniture

acorn



A large range to suit all age groups

EARLY YEARS

Pages 257-275

BEAN BAGS

Pages 276-299

PRIMARY

Pages 295-320

SECONDARY

Pages 321-340



Design & Installation Service



Innovative ideas & designs
with reading & learning at
the heart.

The image is a 3D architectural rendering of a library interior. It features a variety of bookshelves in different shapes and sizes, some with integrated seating. There are several round tables with blue chairs, and a central area with a curved bookshelf and yellow stools. The room has large windows with a view of a green landscape. The overall design is modern and functional.

Planning to create a new Library Space?

Looking for inspiration and new ideas?

Want to know exactly how a new design will look?

Talk to us today about our design & installation service to transform your Library and School.

Get a design from our experienced design team.

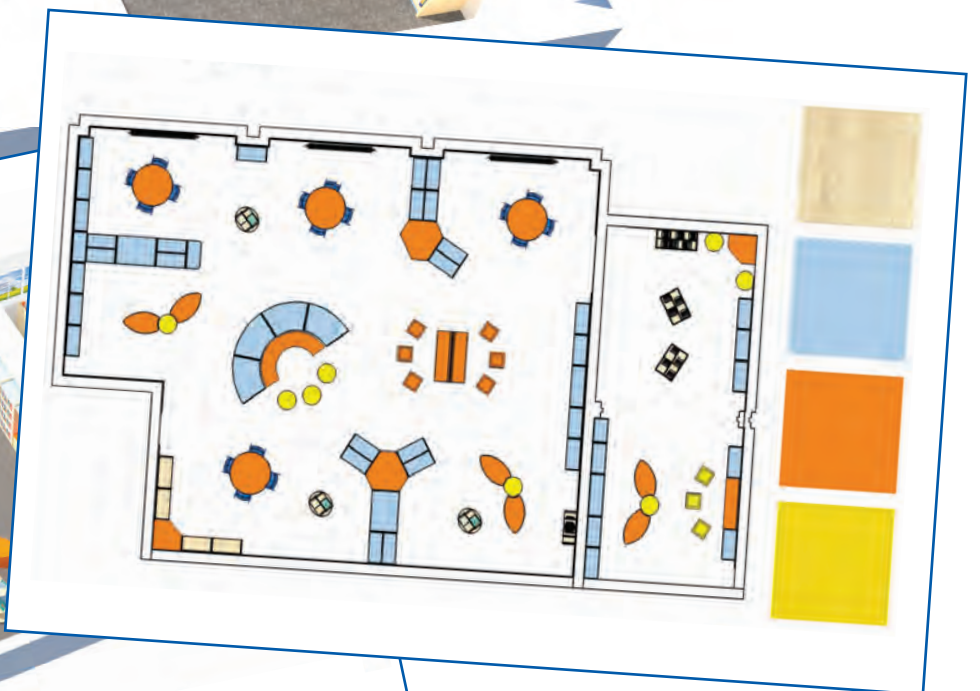

Designed by us - See your new Library in 2D and 3D drawings.



From Concept to Installation.

Whether you are an Academy, School, College or University, we pride ourselves on our professional, innovative and reliable service. We take your vision from the initial idea to designs & plans, right the way through to production and installation. Our process works fully to your convenience to ensure minimal disruption.

Expert Design

Inspiring Children and students to read and learn is at the heart of all of our designs which are thoughtfully made to give motion and flow to any space making it a more social and visually engaging area. We want to make your library space the hub of your school, a place for students to socialise and learn. We understand that a modern school Library needs to be flexible, inviting and energising, ready for a wide range of learning activities.

Creating a Flexible Environment

Our versatile furniture can be used to create zones or pods that could be dedicated to different subjects, genres or activities. Large group work areas can be arranged for whole classes, or small reading dens can be made for readers hoping to get lost in their books.

An Engaging Display

Using a mix of bright colours and elegant curves, our designs give a contemporary look that will energise students and transform any room. We use a wide range of soft seating to create group circles, break outs and fun hideaways that spark imagination.

You're In Safe Hands

Our market leading range of educational furniture has been developed working directly with schools and by our own team of experienced in house designers. No matter how big or small your Library or Classroom project may be, we can create the perfect learning space. Our team will meet you at your school when possible to take measurements and start the design process. Alternatively try our remote design process for even faster results.

More Than Just Library Design

Don't forget, our design service is free for reading corners, classrooms and whole school fit outs too. We're happy to do all of the hard work and when it comes to bringing brilliant design to your school we go the extra mile. Whatever your requirement, talk to us today for a free, no obligation design.

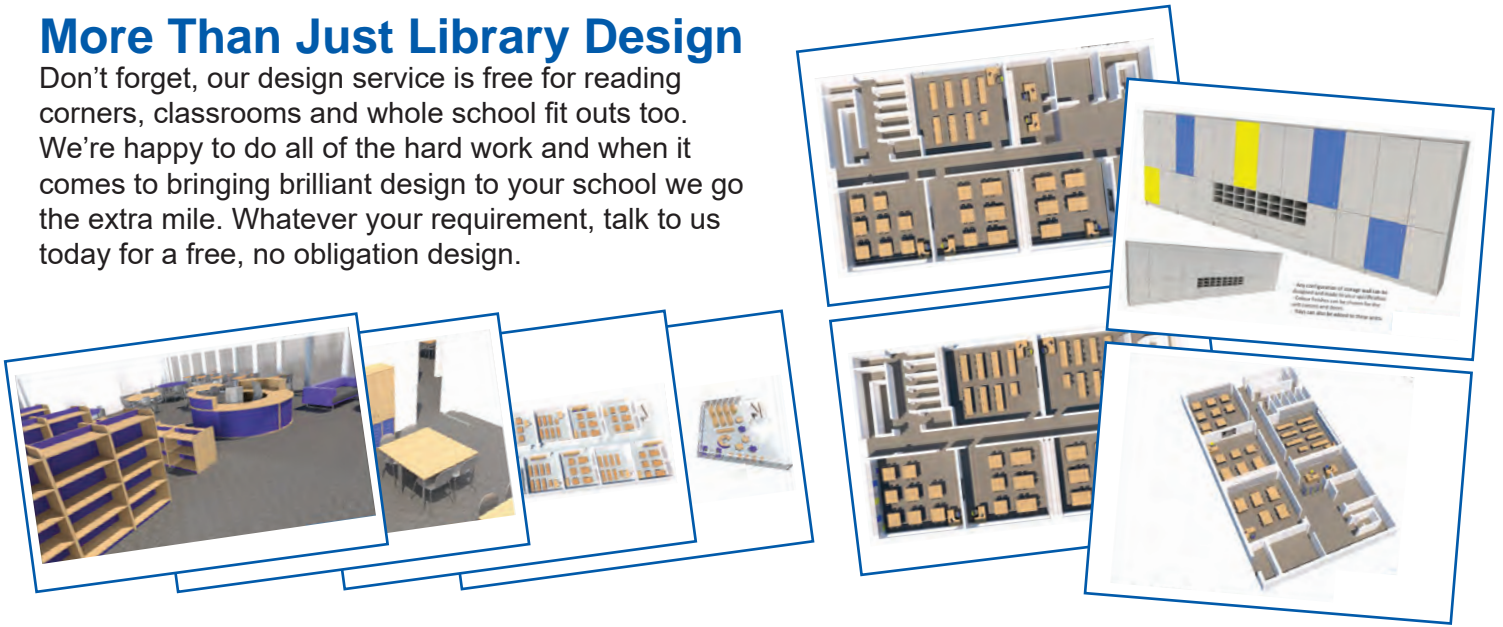



OneStore Teaching Wall 2.0

The OneStore is our flagship Teaching Wall. Designed for teachers and their classrooms. The OneStore creates an ordered room with efficient storage space, ideal to keep students focused and minimise distractions. Modular in its assembly, this teaching wall can be made into any configuration that fits the needs of the area or teacher.

The OneStore 2.0 features 48 Gratnells storage trays in a choice of colours, along with generous cupboard and shelving storage. By having everything conveniently stored away, the learning environment is free from distractions. The centre of this teaching wall is the interactive whiteboard housing. This will fit most

interactive whiteboards. With the screen fitted in the middle of the teaching wall, it gives students a clear focal point.

The OneStore 2.0 includes 2 sliding whiteboard doors which can be used for writing and teaching. The whiteboard doors are soft closing, features aluminium handles on each side and use an aluminium track system.

A teachers desk is incorporated into the design with a removable back panel inside a low cupboard for easy access to data and power ports.

Available in a choice of 5 colours and made from 18mm solid MDF. All with a 10 year guarantee.



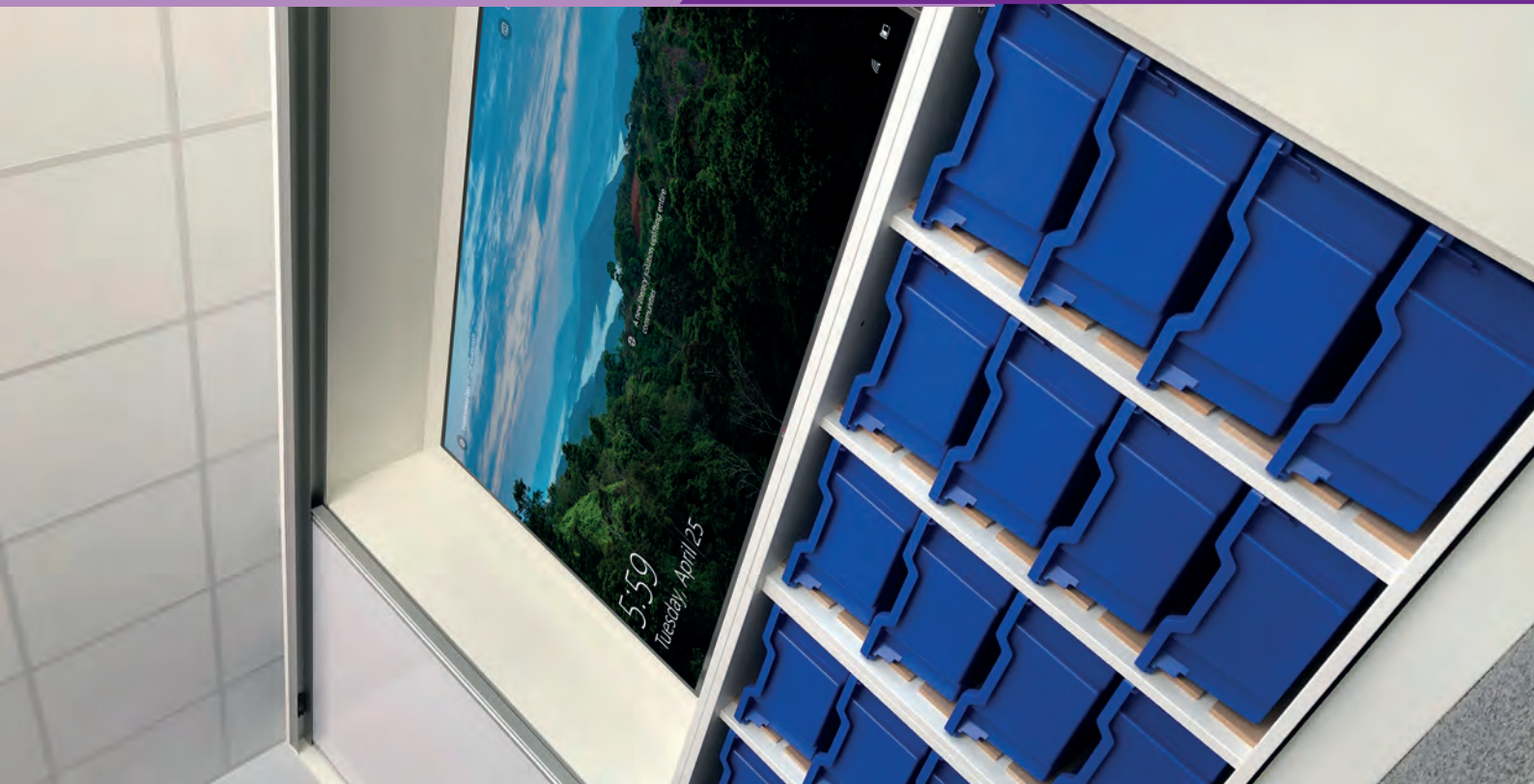

The OneStore 2.0 includes two sliding whiteboard doors for teaching and display. The doors are mounted using a sleek and strong metal sliding runner system. Doors feature soft closing stops for ease of use and avoid any finger trapping. This sliding door system allows the doors to run smoothly and freely with little resistance.



Code	OneStore Teaching Wall - Non-Locking	Price
B76057	H2100mm x W4000mm D480mm	
Code	OneStore Teaching Wall - Locking	Price
B76058	H2100mm x W4000mm D480mm	

Installation is available for the OneStore Teaching Wall 2.0 and is advised. The installation process takes approximately one day per Teaching Wall for completion and is carried out by one of our own installation craftsmen. However, if you would prefer to install the Teaching Wall yourself, then please do not order the installation and we will supply assembly instructions for the OneStore. **Please call us to discuss bespoke sizes and colour requirements.**



Installation (if required) Approximately one day per OneStore

Code	Installation (if required)	Price
B76037	Approximately one day incl. travelling	

Please confirm this before ordering as this may vary depending on your location.



OneStore Teaching Wall



4 Metres Wide

Code	OneStore Teaching Wall - Non-Locking	Price
B76033	H2100mm x W4000mm D600mm	
Code	OneStore Teaching Wall - Locking	Price
B76034	H2100mm x W4000mm D600mm	



5 Metres Wide

Code	OneStore Teaching Wall - Non-Locking	Price
B76035	H2100mm x W5000mm D600mm	
Code	OneStore Teaching Wall - Locking	Price
B76036	H2100mm x W5000mm D600mm	

Installation (if required) - Approximately one day

Code	Installation (if required)	Price
B76037	Approximately one day incl. travelling	

Please confirm this before ordering as this may vary depending on your location.

The standard option for the OneStore 1.0 comes in two sizes, 4 metres and 5 metres wide. Bespoke sizes can also be easily made, please contact us to discuss your requirements. A teachers desk is incorporated into the design with a removable back panel for easy access to data and power ports, a pull out keyboard desk, additional cupboard storage and 9 acrylic pigeonhole spaces. Supplied with 2 sliding soft close, whiteboard doors, 48 shallow Gratnells trays and a generous configuration of cupboard storage with optional locks. Available in a choice of 5 colours and made from 18mm solid MDF. All with a 10 year guarantee. **Call us to discuss bespoke sizes and colour requirements.**



Low Storage Wall



Code	Low Storage Wall - 4.5m Wide - Shown above	Price
B76065	H2000mm x W4500mm D480mm	
Code	Low Storage Wall - 3.5m Wide	Price
B76066	H2000mm x W3500mm D480mm	

Our Low Storage Wall is an easy way to instantly organise your classroom and makes the most of your space. Featuring two open display bookcases, tray and cupboard storage and open low storage. You'll find a place for everything in this cost effective storage wall. Your classroom smartboard in the space between the bookcases direct onto the wall. Made from 18mm solid wood MDF with bump resistant edging. Available in two widths, 3.5m and 4.5m and a choice of 5 colour finishes.

Comes with a 5 year guarantee.



Installation (if required) - Approximately one day

Code	Installation (if required)	Price
B76037	Approximately one day incl. travelling	

Please confirm this before ordering as this may vary depending on your location.





Learning & Storage Walls

These Learning Walls not only provide a strong focal point for classroom environments, it also provides exceptional, dedicated storage that renovates classrooms into stylish, attractive spaces.

These premium units are manufactured in a high quality 18mm maple, beech, white, grey or oak.

Three options are available:

1. Learning Wall
2. Storage Wall
3. Cupboard Wall



Improve your teaching environment



from this...to this!

The Learning Wall

Overall Dimensions: H2100mm x W4080mm x D480mm

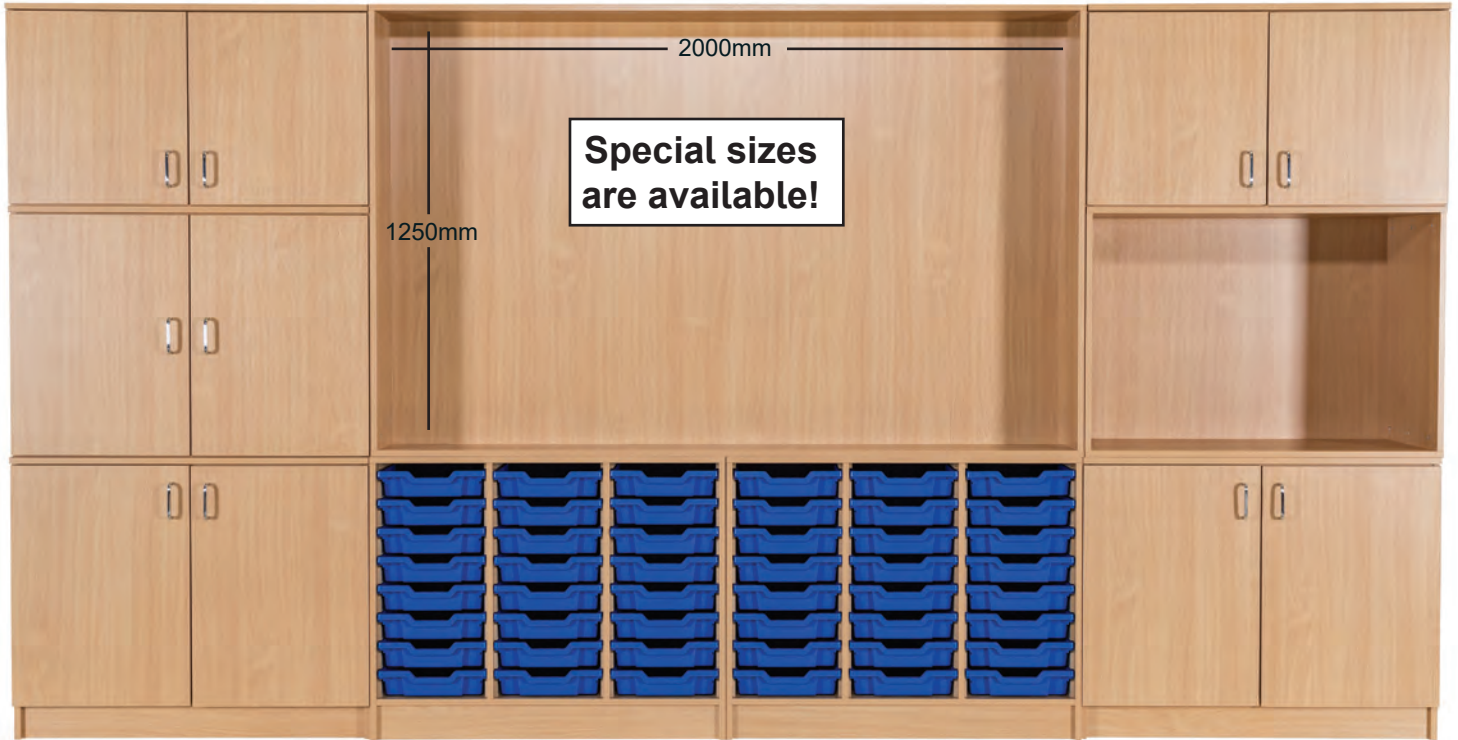

Locking doors available as optional extra.

The Learning Wall

The Learning Wall	
A76005	

The Learning Wall with Locking Doors	
A76006	

The Learning Wall is a classroom essential. With the focal point being the centre area for your intereractive whiteboard. This area measures 1250mm high by 2000mm wide & has a solid back to make sure your smartboards are secured safely.

Special sizes are also not a problem, please call to discuss your requirements.

This Learning Wall also includes five double cupboards, an open workstation space & 2 tray units including 48 Gratnells tray in a choice of colours - trays can also be substituted for Deep, Extra Deep or Jumbo trays.



The Storage Wall

Overall Dimensions: H2100mm x W4080mm x D480mm

Locking doors available as optional extra.

The Storage Wall		The Storage Wall with Locking Doors	
A76001		A76002	



The Storage Wall - all your storage in one place

The Storage Wall provides a variety of storage solutions & includes 4 top cupboards, two middle cupboards, two middle tray units, two floor cupboards & two floor standing tray units.

The Storage Wall has 24 Gratnells Deep trays & 48 Gratnells Shallow tray in a choice of colours - trays can also be swapped for Deep, Extra Deep or Jumbo.

**Special sizes are not a problem.
Call to discuss your requirements**

Choice of colour finishes



Choice of Gratnells Tray Colours



The Cupboard Wall

Overall Dimensions: H2100mm x W4080mm x D480mm

Choice of colour finishes



The Cupboard Wall

The Cupboard Wall provides the ideal storage solution. There are 4 top cupboards, 4 middle cupboards & 4 floor cupboards.



Locking doors available as optional extra.

The Cupboard Wall		The Cupboard Wall with Locks	
A76003		A76004	



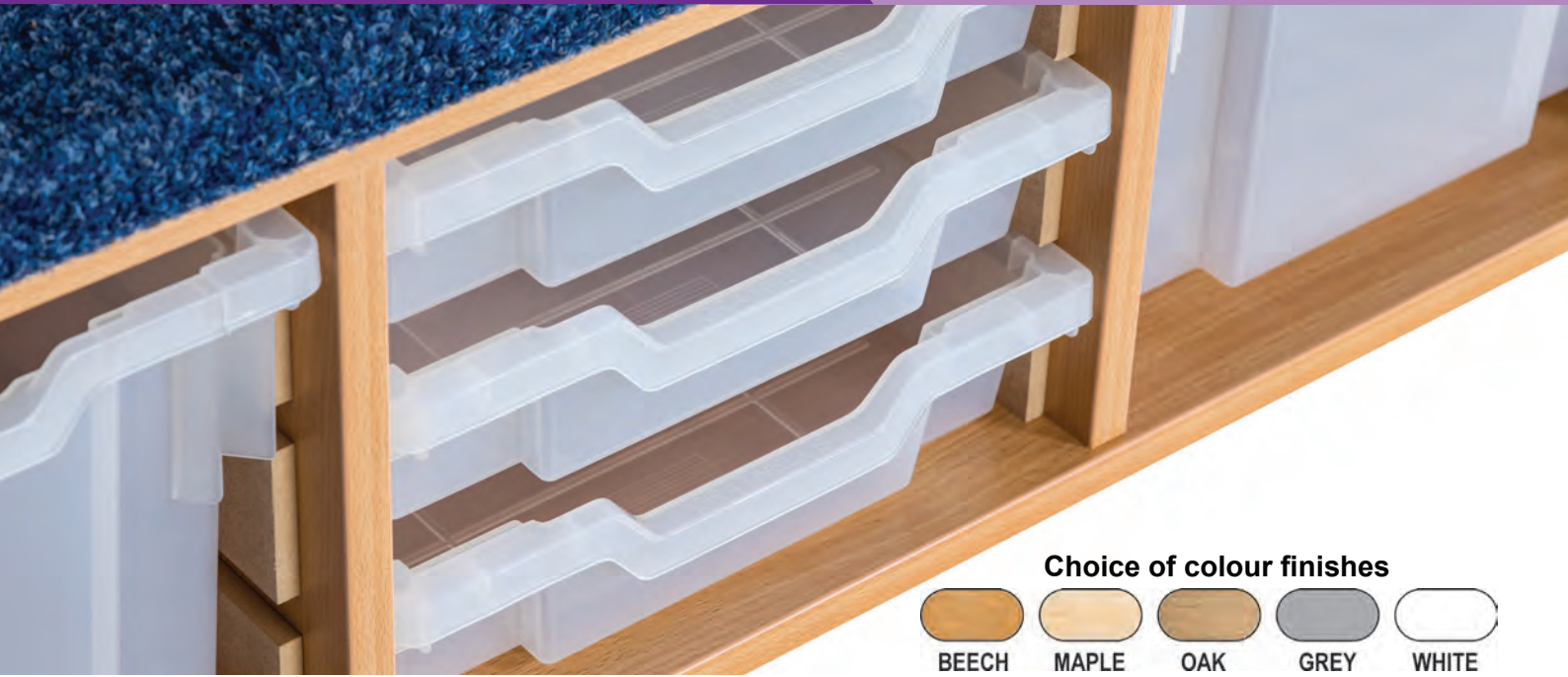

Choice of colour finishes



Premium Classroom Steps

High quality, secure & strong classroom steps used in front of your active whiteboards to aid younger pupils to reach the screen & participate in front of the class.

Supplied with Gratnells trays in a choice of colours.

Each step is built using a high quality, 18mm solid wood MDF in a choice of finishes. A durable navy blue carpet is fitted to the top.



Classroom Step - includes 2 x Deep & 2 x Shallow trays

A18001 H250mm x W1025mm x D500mm

**250mm
HIGH**



Classroom Step - includes 2 x Extra Deep & 3 x Shallow trays

A18002 H335mm x W1025mm x D500mm

**335mm
HIGH**



Classroom Step - includes 2 x Deep & 4 x Shallow trays

A18003 H250mm x W1355mm x D500mm

**250mm
HIGH**



Classroom Step - includes 2 x Extra Deep & 6 x Shallow trays

A18004 H335mm x W1355mm x D500mm

**335mm
HIGH**



Classroom Step - includes 3 x Deep & 4 x Shallow trays

A18005 H250mm x W1690mm x D500mm

**250mm
HIGH**



Classroom Step - includes 3 x Extra Deep & 6 x Shallow trays

A18006 H335mm x W1690mm x D500mm

**335mm
HIGH**

Single Pedestal Desk

1m or 1200mm



All Gratnells trays included in a choice of colours

Two widths available

Code	Single Pedestal Desk - 1m Wide	Price
A25012	H710mm x W1000mm D600mm	
Code	Single Pedestal Desk - 1200mm Wide	Price
A25013	H710mm x W1200mm D600mm	

Teacher's Desk

1m or 1200mm



1000mm Wide

Code	Teacher's Desk	Price
A25007	H710mm x W1000mm D600mm	
Code	Teacher's Desk with Lock	Price
A25008	H710mm x W1000mm D600mm	

1200mm Wide

Code	Teacher's Desk	Price
A25009	H710mm x W1200mm D600mm	
Code	Teacher's Desk with Lock	Price
A25010	H710mm x W1200mm D600mm	



Choice of colour finishes



General Desk

1m or 1200mm



Two widths available

Code	1000mm Wide General Desk	Price
A25014	H710mm x W1000mm D600mm	
Code	1200mm Wide General Desk	Price
A25015	H710mm x W1200mm D600mm	

Double Pedestal Desk

1400mm



All Gratnells trays included in a choice of colours

With or without locks

Code	Double Pedestal Desk	Price
A25016	H710mm x W1400mm D600mm	
Code	Double Pedestal Desk with Locks	Price
A25029	H710mm x W1400mm D600mm	



Premium Quality Classroom Tables

- Fully welded frame
- Tough epoxy coating
- Choice of top & edge colours
- Premium silver frame (RAL9006)

Choose your height:

Euro 1	Ages 3-4	460mm
Euro 2	Ages 4-6	530mm
Euro 3	Ages 6-8	590mm
Euro 4	Ages 8-11	640mm
Euro 5	Ages 11-14	710mm
Euro 6	Ages 14-Adult	760mm



CHOICE OF TOP FINISHES

BEECH	MAPLE	OAK	GREY	WHITE

CHOICE OF EDGE COLOURS

BEECH	MAPLE	OAK	GREY
WHITE	RED	BLUE	GREEN
YELLOW	PLUM	ORANGE	LIME

600mm x 600mm Classroom Table



Code	600mm Classroom Table	Price
T6060	W600mm x D600mm	

Don't forget to Choose Your Height!

600mm x 600mm Classroom Table with Tray



Trays available in all Gratnells colours

Code	600mm Classroom Table	Price
T6060TR	W600mm x D600mm	

Don't forget to Choose Your Height!

1100mm x 550mm Classroom Table



Code	1100mm Classroom Table	Price
T1155	W1100mm x D550mm	

Don't forget to Choose Your Height!

1100mm x 550mm Classroom Table with 2 x Trays



Trays available in all Gratnells colours

Code	1100mm Classroom Table	Price
T1155TR	W1100mm x D550mm	

Don't forget to Choose Your Height!

1200mm x 600mm Classroom Table



Code	1200mm Classroom Table	Price
T1260	W1200mm x D600mm	

Don't forget to Choose Your Height!

1200mm x 600mm Classroom Table with 2 x Trays



Trays available in all Gratnells colours

Code	1200mm Classroom Table	Price
T1260TR	W1200mm x D600mm	

Don't forget to Choose Your Height!

Science & Craft Tables



16mm Trespa tops on all science tables.

Science tables with a 16mm thick Trespa table top. Originally designed for Lab use but suits any environment requiring a hardwearing and durable table. This style of table is found in Science Labs all over the UK. Featuring adjustable levelling feet to ensure a stable work surface.

Trespa worktops are a low maintenance solution and provide a tough, solid and sturdy work surface that is antibacterial & chemical resistant. Available with a choice of White [E0-00] or Speckled Pastel Grey [S0-015] (as Pictured) tops.

Choose your height:

- 760mm
- 800mm
- 850mm
- 900mm
- 1000mm

Other Trespa colours available - Please ask for details.

600mm x 600mm H-Frame Lab Table



Choose your height:

- 760mm
- 800mm
- 850mm
- 900mm
- 1000mm

Don't forget to Choose Your Height!

Code	600mm H-Frame Lab Table	Price
TSH6060	W600mm x D600mm	

TRESPA®

1200mm x 600mm H-Frame Lab Table



Choose your height:

- 760mm
- 800mm
- 850mm
- 900mm
- 1000mm

Don't forget to Choose Your Height!

Code	1200mm H-Frame Lab Table	Price
TSH1260	W1200mm x D600mm	

TRESPA®

600mm x 600mm H-Frame Craft Table



Choose your height:

- 760mm
- 800mm
- 850mm
- 900mm
- 1000mm

Don't forget to Choose Your Height!

Code	600mm H-Frame Craft Table	Price
TCH6060	W600mm x D600mm	

Beech top

1200mm x 600mm H-Frame Craft Table



Choose your height:

- 760mm
- 800mm
- 850mm
- 900mm
- 1000mm

Don't forget to Choose Your Height!

Code	1200mm H-Frame Craft Table	Price
TCH1260	W1200mm x D600mm	0

Beech top

1200mm or 1500mm Hexagon Tables



Don't forget to Choose Your Height!

Check your chair widths.
1200mm Dia. distance between legs is 490mm.

Suitable for K1 Postura Chairs sizes: 1, 2, 3, 4, 5, & 6

Ages 3-4	Height 460mm	E1
Ages 4-6	Height 530mm	E2
Ages 6-8	Height 590mm	E3
Ages 8-11	Height 640mm	E4
Ages 11-14	Height 710mm	E5
Ages 14-Adult	Height 760mm	E6

Code	1200mm Hexagon Table	Price
KCTAB5A	1200mm Diameter	
KCTAB44	1500mm Diameter	

CHOICE OF TOP FINISHES

BEECH

MAPLE

OAK

GREY

WHITE

1200mm or 1500mm 6 Leaf Petal Tables



Don't forget to Choose Your Height!

Check your chair widths.
1200mm Dia. distance between legs is 490mm.

Suitable for K1 Postura Chairs sizes: 1, 2, 3, 4, 5, & 6

Ages 3-4	Height 460mm	E1
Ages 4-6	Height 530mm	E2
Ages 6-8	Height 590mm	E3
Ages 8-11	Height 640mm	E4
Ages 11-14	Height 710mm	E5
Ages 14-Adult	Height 760mm	E6

Code	1200mm 6 Leaf Petal Table	Price
KCTAB3A	1200mm Diameter	
KCTAB45	1500mm Diameter	

CHOICE OF TOP FINISHES

BEECH

MAPLE

OAK

GREY

WHITE

RetroMod School Desk

The traditional, favourite classroom desk.

We have revitalised the traditional, old school desk that remained a firm favourite for generations & created a new look classic that is ideal for the modern classroom.

Ideal for social distancing, the desk is constructed using metal legs, coated in a tough, durable epoxy finish. Includes hinges that match in style to the original desks, maintaining the retro feel of a classic icon.

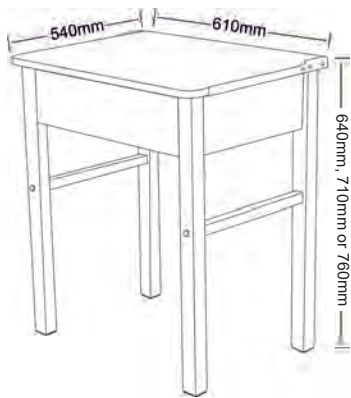



Width 610mm x Depth 540mm

640mm - E4

D83001	640mm High (480mm Leg clearance from floor)	
---------------	---	--

710mm - E5

D83002	710mm High (550mm Leg clearance from floor)	
---------------	---	--

760mm - E5

D83003	760mm High (600mm Leg clearance from floor)	
---------------	---	--

Choose your top colour:



Choose your frame colour:



RetroMod School Desk

The RetroMod Study Desk is the perfect solution to social distancing in the classroom. Textbooks, workbooks, pencils and craft materials can all be safely put away into the storage section of the desk, preventing cross contamination of materials and work.

Please check your desk heights before ordering.

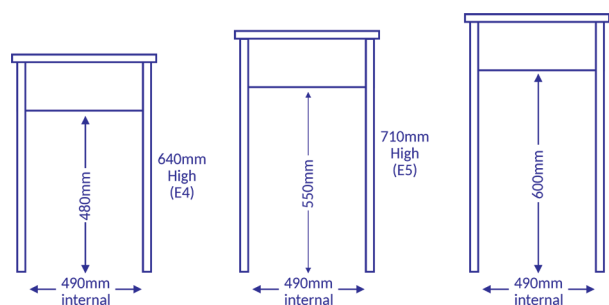



The Utile Whiteboard Table

Flip-Top Mobile Whiteboard Table, for collaboration, presentation and perceptions.

- Began as a way for students to develop their skills in presenting and discussing their viewpoints.
- Can be used for a wide range of group activities, debates, problem solving, pro/con exercises etc.
- Entire lessons are structured around the use of these tables.
- Engages well with students and encourages them to participate in class work.
- Allows students to draft an answer which can be altered.
- Foldable for display or storage.
- Allows teachers to quickly assess how well a class is grasping a concept.
- A good way to encourage students of low confidence to put forward an idea.

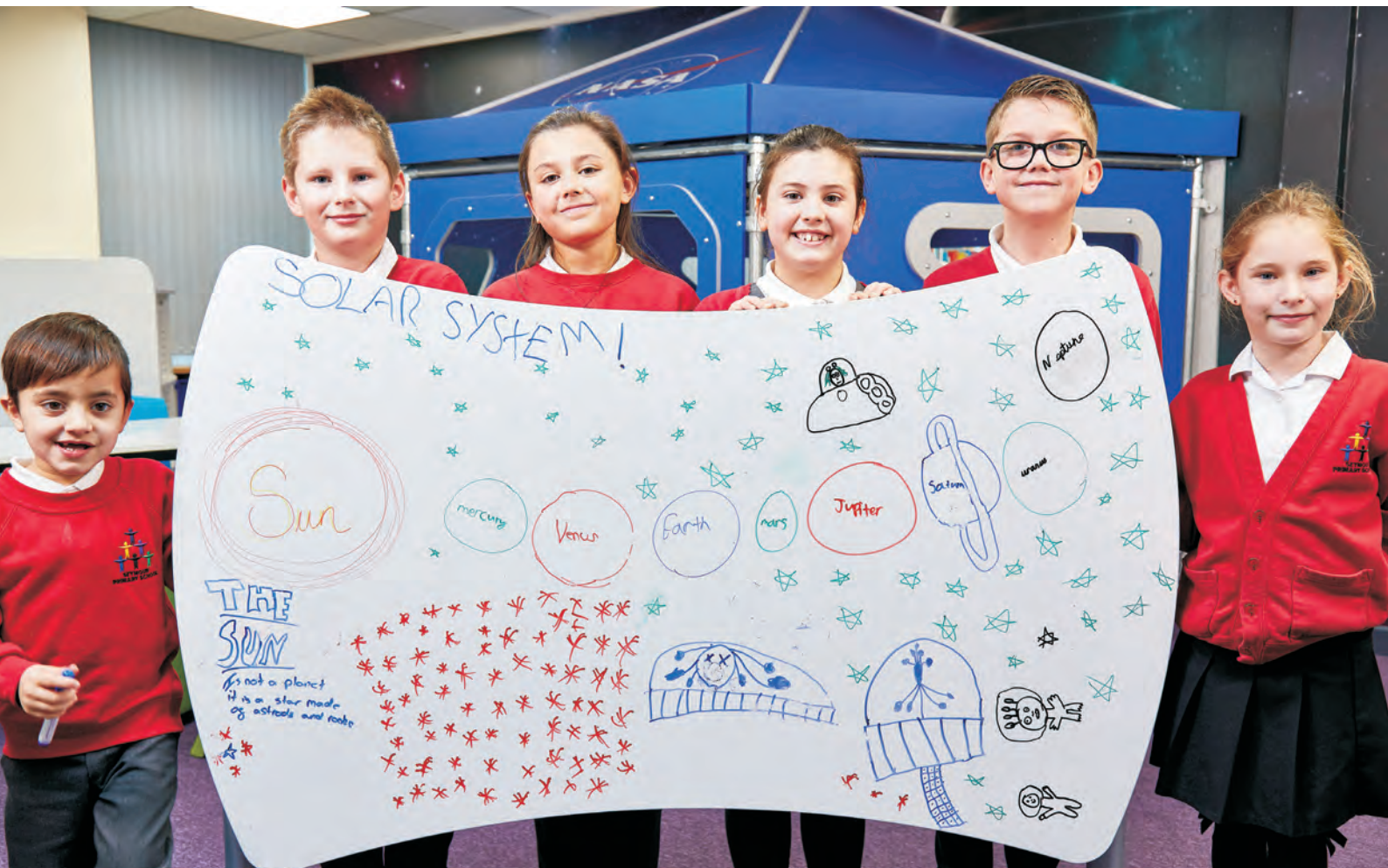



Utile Tilting Whiteboard Tables		
B66002	H733mm x W1400mm x D875mm	



Tilts to display



Wipe clean surface

Children's Comments:

- 'It makes lessons more fun because it makes a nice change from writing in books all the time.' **Ronan Y6**
- 'Much more spacious to write on and easier to use than whiteboards in the class.' **Max Y6**
- 'You can show other people your work by flipping up the tables and you can move them around.' **Olivia Y6**
- 'They're really good because I'm not worried about making mistakes because you can easily rub your work out and change it.' **Ayla Y6**

Teacher's Comments:

- 'The tables give the children the opportunity to not worry about mistakes and to try challenges without the fear of failing because mistakes can be rubbed out and easily corrected.'
- There are space constraints that we experience with mini whiteboards that are used in most primary schools.'
- 'They can flip up and children can share their ideas with the rest of the class.'
- 'They help with group work and promote discussion when note making. Four children can fit comfortably around a table and can work collaboratively with plenty of space to write.'
- Ideal for problem solving and can be used for all subjects. The children love the opportunity to use the tables, the novelty never wears off.'
- 'High quality, durable and easy to keep clean.'
- 'Perfect for whole class teaching and for invention groups and suitable for children of all ages.'



Ian Taylor, Head Teacher

Ernesford Grange Primary School

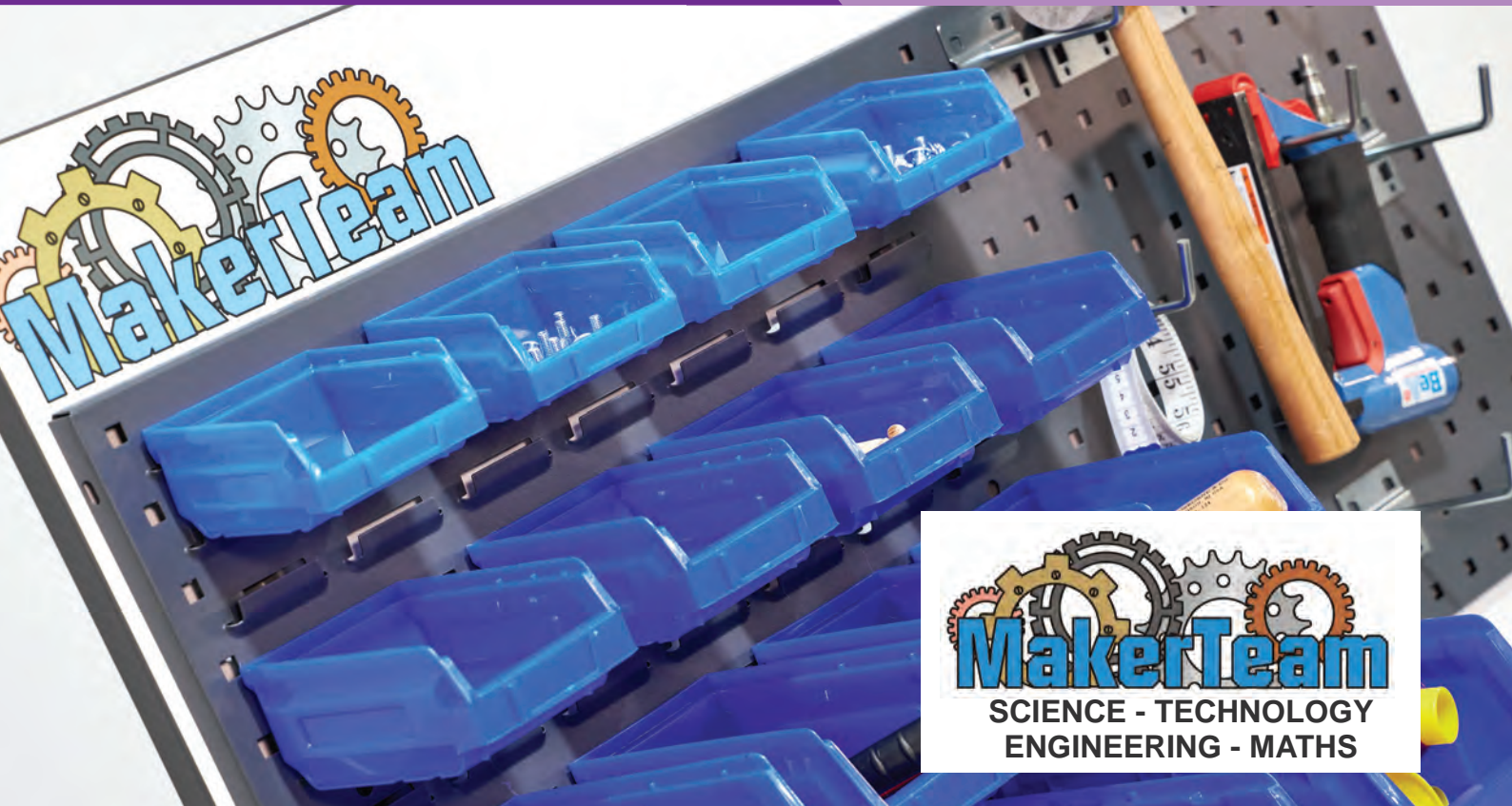

MakerTeam Station Trolley

H1480mm x W1050mm x D460mm



Solid whiteboard back for sharing design ideas



CERTWOOD Superior quality CRYSTAL CLEAR trays.

Heavy duty, high quality, locking castors.

Heavy duty, high quality bins mounted on a metal panel.



Code	MakerTeam Station Trolley	Price
C77002	H1480mm x W1050mm x D460mm	



MakerTeam Collaborative Mobile Whiteboard

H1630mm x W1410mm x D650mm



Code	MakerTeam Collaborative Mobile Whiteboard	Price
C77005	H1630mm x W1410mm x D650mm	

MakerTeam Collaborative Mobile Whiteboard with Storage

H1630mm x W1410mm x D650mm

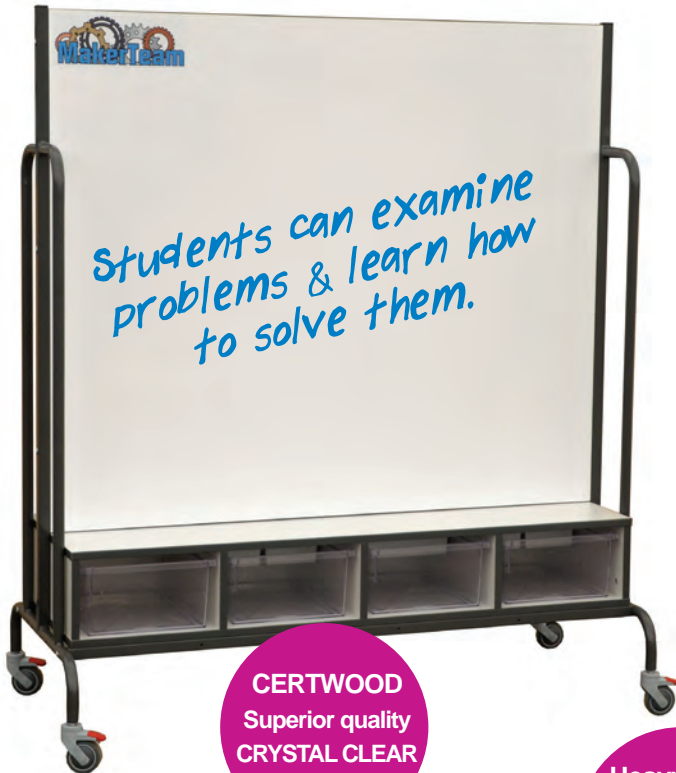

CERTWOOD
Superior quality
CRYSTAL CLEAR
trays.

Code	MakerTeam Collaborative Mobile Whiteboard with storage	Price
C77006	H1630mm x W1410mm x D650mm	

Heavy duty,
high quality,
locking
castors.



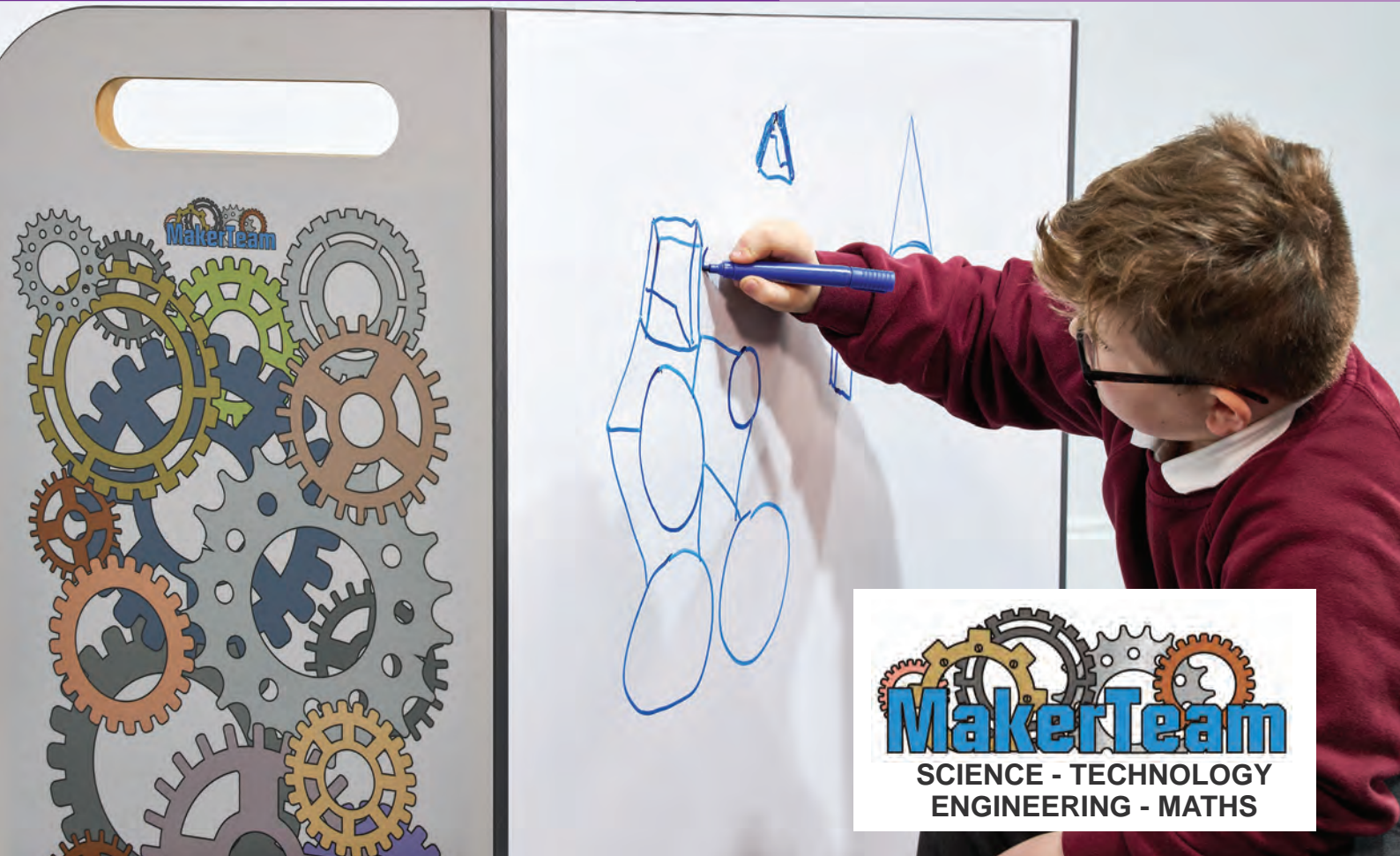

Heavy duty,
high quality,
locking
castors.

MakerTeam 4 Shelf Trolley

H990mm x W1050mm x D460mm

Solid
whiteboard
back for sharing
design ideas

Ideal for works
in progress.
Safe & ready for
next lesson.

Code	MakerTeam 4 Shelf Trolley	Price
C77003	H990mm x W1050mm x D460mm	

MakerTeam Double Sided Components Trolley

H990mm x W810mm x D650mm



Heavy duty,
high quality,
locking
castors.

Heavy duty,
high quality
bins mounted
on a metal panel
on each side.

Code	MakerTeam D/S Components Trolley	Price
C77004	H990mm x W810mm x D650mm	



For Reception Seating see our Acorn section



Premium Coffee Tables

1200mm Premium Coffee Table with Shelf

Height 450mm x Width 1200mm x Depth 600mm

Photo in
Beech finish



1200mm Wide Coffee Table with Shelf

A25001

1200mm D-End Premium Coffee Table with Shelf

Height 450mm x Width 1200mm x Depth 600mm

Photo in
Oak finish



1200mm D-End Coffee Table with Shelf

A25004

900mm Premium Coffee Table with Shelf

Height 450mm x Width 900mm x Depth 600mm



600mm Premium Coffee Table with Shelf

Height 450mm x Width 600mm x Depth 600mm



900mm Wide Coffee Table with Shelf
A25002

Photo in
Beech finish

600mm Wide Coffee Table with Shelf
A25003

Photo in
Beech finish

600mm Premium Metal Frame Coffee Table

Height 450mm x Width 600mm x Depth 600mm



600mm Wide Coffee Table - metal legs
A25006

Photo in
Beech finish

600mm Premium Coffee Table

Height 450mm x Width 600mm x Depth 600mm



600mm Wide Coffee Table
A25005

Photo in
Maple finish



Wall Mountable File Units

These high quality wall mountable file units hold boxfiles, lever arch or ring binder files.

Each unit comes supplied complete with adjustable wall hanging brackets. Please make sure the wall you are securing too is solid & able to hold the unit safely. Screws are not provided as you will need to use the correct screws for the type of wall you wish to hang the unit on.

All internal heights are 384mm to accomodate the larger Boxfile size. All shelf depths are 304mm.

The units are all available in a choice of five finishes, those shown are built in Maple finish.

The units with doors have the choice of locks as an optional extra.

Choice of colour finishes



BEECH

MAPLE

OAK

GREY

WHITE

5 File Open Wall Unit

H438mm x W440mm x D330mm



5 File Open Unit

A45001

5 File Wall Cupboard

H438mm x W440mm x D350mm



5 File Wall Cupboard

A45002

5 File Wall Cupboard with Lock

A45009

10 File Open Wall Unit

H840mm x W440mm x D330mm



10 File Open Wall Unit

A45003

10 File Wall Cupboard

H840mm x W440mm x D350mm



10 File Wall Cupboard

A45004

10 File Wall Cupboard with Lock

A45010

10 File Open Wall Unit

H438mm x W840mm x D330mm



10 File Open Wall Unit

A45007

10 File Wall Cupboard

H438mm x W840mm x D350mm



10 File Wall Cupboard

A45008

10 File Wall Cupboard with Lock

A45012

20 File Open Wall Unit

H840mm x W840mm x D330mm



20 File Open Unit

A45005

20 File Wall Cupboard

H840mm x W840mm x D350mm



20 File Wall Cupboard

A45006

20 File Wall Cupboard with Lock

A45011

WALL PIGEONHOLES



Wall Mountable Pigeon Holes

Very high quality & stylish pigeonhole units. Formed, clear acrylic shelves are a sturdy 3mm thick & come complete with name strips. There is a downloadable template for Word so you can create neat & tidy names or titles.

Please note: Acrylic shelves come with a protective film on both sides that should be peeled off before use & then apply the labelling strip.

Units come complete with metal adjustable hanging brackets. Please make sure that the wall you are securing the unit to is solid & able to take the weight of the unit safely. Screws are not provided as you will need to use the relevant type of fixing for your chosen wall. If unsure please consult a qualified tradesman.

Pigeonholes shown in our Oak Finish.



Choice of finishes

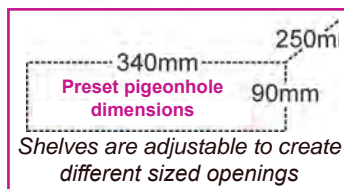

Clear acrylic shelves



Supplied with name label holder

**Wall Mountable
3 x Pigeonhole**

H360mm x W380mm x D285mm



3 Space WM Pigeonhole

A35001

Wall Mountable 6 x Pigeonhole

H360mm x W738mm x D285mm



6 Space WM Pigeonhole

A35004

Wall Mountable 9 x Space Pigeonhole

H360mm x W1096mm x D285mm



9 Space WM Pigeonhole

A35007

**Wall Mountable
4 x Pigeonhole**

H460mm x W380mm x D285mm



4 Space WM Pigeonhole

A35002

Wall Mountable 8 x Pigeonhole

H460mm x W738mm x D285mm



8 Space WM Pigeonhole

A35005

Wall Mountable 12 x Space Pigeonhole

H460mm x W1096mm x D285mm



12 Space WM Pigeonhole

A35008

**Wall Mountable
5 x Pigeonhole**

H560mm x W380mm x D285mm



5 Space WM Pigeonhole

A35003

Wall Mountable 10 x Pigeonhole

H560mm x W738mm x D285mm



10 Space WM Pigeonhole

A35006

Wall Mountable 15 x Space Pigeonhole

H560mm x W1096mm x D285mm



15 Space WM Pigeonhole

A35009

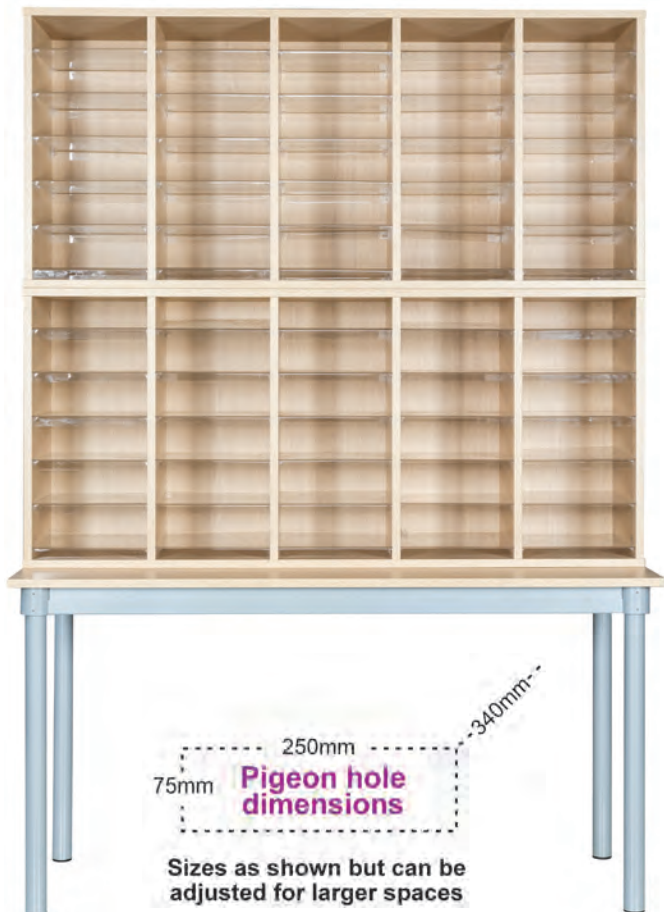

Pigeon Holes

Ideal for sorting post & distributing mail. All pigeon holes are manufactured from quality 18mm laminate & are available in 5 colours - Beech, Maple, Oak, Grey or White.

All shelves are fully adjustable with 32mm hole spacings. The clear acrylic shelves come complete with a label holder for the front - A template for you to download is also available for opening in Word to type in the name or title to give a neat appearance. These units are solid & heavy but we have designed them as modular parts which simply connect together with the supplied fixings.

Three base options are available, a table option, a cupboard option or a high capacity option.

Choice of finishes



TABLE OPTION



CUPBOARD OPTION

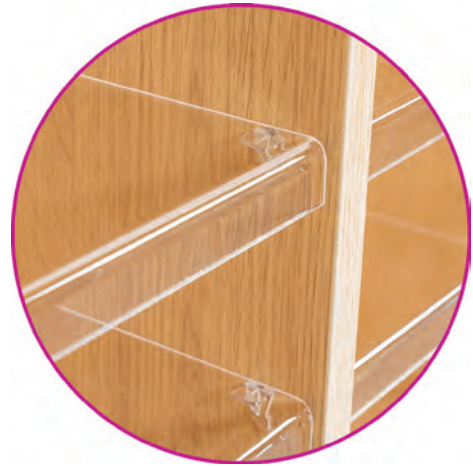

All units have clear acrylic shelves



All units supplied with name label holder

HIGH CAPACITY OPTION



PIGEONHOLE UNITS

12 Space with Table

H1320mm x W558mm x D600mm



12 Space Pigeonhole + Table
A33001

12 Space with Cupboard

H1320mm x W558mm x D375mm



12 Space Pigeonhole + Cupboard
A33002
12 Space Pigeonhole Cup + Locks
A33003

24 Space Pigeonhole

H1320mm x W558mm x D375mm



24 Space Pigeonhole
A33004

24 Space with Table

H1930mm x W558mm x D600mm



24 Space Pigeonhole + Table
A33005

24 Space with Cupboard

H1930mm x W558mm x D375mm



24 Space Pigeonhole + Cupboard
A33006
24 Space Pigeonhole Cup + Locks
A33007

36 Space Pigeonhole

H1930mm x W558mm x D375mm



36 Space Pigeonhole
A33008

18 Space with Table

H1320mm x W826mm x D600mm



18 Space Pigeonhole + Table
A33009

18 Space with Cupboard

H1320mm x W826mm x D375mm



18 Space Pigeonhole + Cupboard
A33010
18 Space Pigeonhole Cup + Locks
A33011

36 Space Pigeonhole

H1320mm x W826mm x D375mm



36 Space Pigeonhole
A33012

36 Space with Table

H1930mm x W826mm x D600mm



36 Space Pigeonhole + Table
A33013

36 Space with Cupboard

H1930mm x W826mm x D375mm



36 Space Pigeonhole + Cupboard
A33014
36 Space Pigeonhole Cup + Locks
A33015

54 Space Pigeonhole

H1930mm x W826mm x D375mm



54 Space Pigeonhole
A33016

PIGEONHOLE UNITS

24 Space with Table

H1320mm x W1094mm x D600mm



24 Space Pigeonhole + Table

A33019

24 Space with Cupboard

H1320mm x W1094mm x D375mm



24 Space Pigeonhole + Cupboard

A33020

24 Space Pigeonhole Cup + Locks

A33021

48 Space Pigeonhole

H1320mm x W1094mm x D375mm



48 Space Pigeonhole

A33022

48 Space with Table

H1930mm x W1094mm x D600mm



48 Space Pigeonhole + Table

A33023

48 Space with Cupboard

H1930mm x W1094mm x D375mm



48 Space Pigeonhole + Cupboard

A33024

48 Space Pigeonhole Cup + Locks

A33025

72 Space Pigeonhole

H1930mm x W1094mm x D375mm



72 Space Pigeonhole

A33026

30 Space with Table

H1320mm x W1362mm x D600mm



30 Space Pigeonhole + Table	
A33028	

30 Space with Cupboard

H1320mm x W1362mm x D375mm



30 Space Pigeonhole + Cupboard	
A33040	
30 Space Pigeonhole Cup + Locks	
A33041	

60 Space Pigeonhole

H1320mm x W1362mm x D375mm



60 Space Pigeonhole	
A33042	

60 Space with Table

H1930mm x W1362mm x D600mm



60 Space Pigeonhole + Table	
A33029	

60 Space with Cupboard

H1930mm x W1362mm x D375mm



60 Space Pigeonhole + Cupboard	
A33057	
60 Space Pigeonhole Cup + Locks	
A33054	

90 Space Pigeonhole

H1930mm x W1362mm x D375mm



90 Space Pigeonhole	
A33043	

PIGEONHOLE UNITS

6 Space Single Column

H710mm x W290mm x D375mm

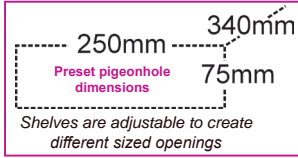

6 Space Pigeonhole Unit
A36001

7 Space Single Column

H806mm x W290mm x D375mm



7 Space Pigeonhole Unit
A36002

8 Space Single Column

H902mm x W290mm x D375mm



8 Space Pigeonhole Unit
A36003

9 Space Single Column

H998mm x W290mm x D375mm

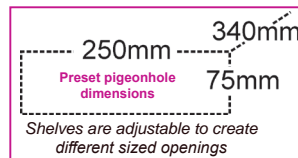

9 Space Pigeonhole Unit
A36004

10 Space Single Column

H1094mm x W290mm x D375mm



10 Space Pigeonhole Unit
A36005

12 Space Single Column

H1286mm x W290mm x D375mm



12 Space Pigeonhole Unit
A36006

12 Space Double Column Pigeonhole

H710mm x W558mm x D375mm



12 Space Pigeonhole Unit	
A36007	

14 Space Double Column Pigeonhole

H806mm x W558mm x D375mm



14 Space Pigeonhole Unit	
A36008	

16 Space Double Column Pigeonhole

H902mm x W558mm x D375mm



16 Space Pigeonhole Unit	
A36009	

18 Space Double Column Pigeonhole

H998mm x W558mm x D375mm



18 Space Pigeonhole Unit	
A36010	

20 Space Double Column Pigeonhole

H1094mm x W558mm x D375mm



20 Space Pigeonhole Unit	
A36011	



Clear acrylic shelves



Supplied with name label holder

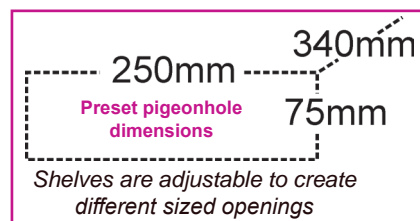

PIGEONHOLE UNITS

18 Space Triple Column Pigeonhole

H710mm x W826mm x D375mm



18 Space Triple Pigeonhole

A36013

21 Space Triple Column Pigeonhole

H806mm x W826mm x D375mm



21 Space Triple Pigeonhole

A36014

24 Space Triple Column Pigeonhole

H902mm x W826mm x D375mm



24 Space Triple Pigeonhole

A36015

27 Space Triple Column Pigeonhole

H998mm x W826mm x D375mm



27 Space Triple Pigeonhole

A36016

30 Space Triple Column Pigeonhole

H1094mm x W826mm x D375mm



30 Space Triple Pigeonhole

A36017



Clear acrylic shelves



Supplied with name label holder

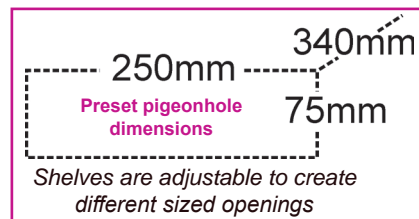

24 Space Quad Column Pigeonhole

H710mm x W1094mm x D375mm



24 Space Triple Pigeonhole

A36019

28 Space Quad Column Pigeonhole

H806mm x W1094mm x D375mm



28 Space Triple Pigeonhole

A36020

32 Space Quad Column Pigeonhole

H902mm x W1094mm x D375mm



32 Space Triple Pigeonhole

A36021

36 Space Quad Column Pigeonhole

H998mm x W1094mm x D375mm



36 Space Triple Pigeonhole

A36022

40 Space Quad Column Pigeonhole

H1094mm x W1094mm x D375mm



40 Space Triple Pigeonhole

A36023



Clear acrylic shelves



Supplied with name label holder

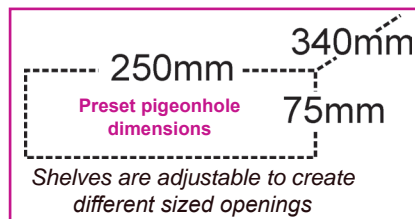

The Office Organiser

OPTION ①



File storage.
Will take all sizes of files up to a 380mm height.

18 Pigeonhole spaces.
Adjustable acrylic shelves supplied with label strips.



Supplied with name label holder

Base cupboard.
With adjustable shelf.
Available with or without locks.



Code	The Office Organiser - Option 1	Price
A76023	H1980mm x W826mm x D480mm Without Locks	
A76024	H1980mm x W826mm x D480mm With Locks	

Choice of colour finish



The Office Organiser

OPTION ③

File storage.

Will take all sizes of files up to a 380mm height.

24 Pigeonhole spaces.

Adjustable acrylic shelves supplied with label strips.

Base cupboards.

With adjustable shelves & 7 Gratnells trays in a choice of colours.

Doors available with or without locks.



Supplied with name label holder

Code	The Office Organiser - Option 3		Price
A76027	H1980mm x W1094mm x D480mm	Without Locks	
A76028	H1980mm x W1094mm x D480mm	With Locks	



The Office Organiser

OPTION ②

File storage.

Will take all sizes of files up to a 380mm height.

24 Pigeonhole spaces.

Adjustable acrylic shelves supplied with label strips.

Base cupboard.

With adjustable shelf.
Available with or without locks.



Supplied with name label holder

Code	The Office Organiser - Option 2		Price
A76025	H1980mm x W1094mm x D480mm	Without Locks	
A76026	H1980mm x W1094mm x D480mm	With Locks	

The Office Organiser

OPTION ④

File storage.
Will take all sizes of files up to a 380mm height.

30 Pigeonhole spaces.
Adjustable acrylic shelves supplied with label strips.

Base cupboards.
With adjustable shelves.
Available with or without locks.



Supplied with name label holder

Choice of colour finish



Code	The Office Organiser - Option 4	Price
A76029	H1980mm x W1362mm x D480mm Without Locks	
A76030	H1980mm x W1362mm x D480mm With Locks	

The Office Organiser

OPTION 5

File storage.

Will take all sizes of files up to a 380mm height.

30 Pigeonhole spaces.

Adjustable acrylic shelves supplied with label strips.

Base cupboards.

With adjustable shelves.
14 Gratnells trays in a choice of colours are included.
Available with or without locks.



Supplied with name label holder

Choice of colour finish



Code	The Office Organiser - Option 5	Price
A76031	H1980mm x W1362mm x D480mm Without Locks	
A76032	H1980mm x W1362mm x D480mm With Locks	

Boxfile Cupboards & Storage Units

Tidy up your office with these high quality boxfile units. Available in a large range of sizes, as single, double or triple bays.

Each unit holds boxfiles, lever arch files or ring binders making your office space neat & organised.

The shelf height is 380mm to accommodate the largest of files.

Manufactured in an 18mm solid wood MDF, these units are strong & durable & come with a bump resistant PVC edging.

Cupboards are available with a lock option & come in a choice of finishes.

All our high quality units have a 5 year guarantee as standard.



- Superior quality units
- Choice of colour finishes
- 5 year guarantee
- Holds Boxfile, Lever Arch or Ring Binders

Choice of colour finishes



BEECH

MAPLE

OAK

GREY

WHITE

20 File Open Unit
H1710mm x W440mm x D330mm



Holds:
Boxfiles,
Lever Arch or
Ring Binders

20 File Open Unit	
A41011	

20 File Half Cupboard
H17108mm x W440mm x D350mm



Holds:
Boxfiles,
Lever Arch or
Ring Binders

20 File Half Cupboard	
A41012	
20 File Half Cupboard with Lock	
A41013	

20 File Cupboard
H1710mm x W440mm x D350mm



Holds:
Boxfiles,
Lever Arch or
Ring Binders

20 File Cupboard	
A41014	
20 File Cupboard with Lock	
A41015	

40 File Open Unit
H1710mm x W858mm x D330mm



Holds:
Boxfiles,
Lever Arch or
Ring Binders

40 Boxfile Open Unit	
A42013	

40 File Half Cupboard

H1710mm x W858mm x D350mm



Holds:
Boxfiles,
Lever Arch or
Ring Binders

40 File Half Cupboard	
A42014	
40 File Half Cupboard with Locks	
A42015	

40 File Cupboard

H1710mm x W858mm x D350mm



Holds:
Boxfiles,
Lever Arch or
Ring Binders

40 File Cupboard	
A42016	
40 File Cupboard with Locks	
A42017	

40 File Cupboard

H1710mm x W858mm x D350mm



Holds:
Boxfiles,
Lever Arch or
Ring Binders

40 File Cupboard	
A42018	
40 File Cupboard with Lock	
A42028	

25 File Open Unit

H2108mm x W440mm x D330mm



Holds:
Boxfiles,
Lever Arch or
Ring Binders

25 Boxfile Open Unit	
A41016	

25 File Half Cupboard

H2108mm x W440mm x D350mm



Holds:
Boxfiles,
Lever Arch or
Ring Binders

25 File Half Cupboard	
A41017	
25 File Half Cupboard with Lock	
A41018	

25 File Cupboard

H2108mm x W440mm x D350mm



Holds:
Boxfiles,
Lever Arch or
Ring Binders

25 Boxfile Cupboard	
A41019	
25 Boxfile Cupboard with Lock	
A41020	

50 Boxfile Open Unit

H2108mm x W858mm x D330mm



Holds:
Boxfiles,
Lever Arch or
Ring Binders

50 Boxfile Open Unit	
A42019	

50 File Half Cupboard

H2108mm x W858mm x D350mm



Holds:
Boxfiles,
Lever Arch or
Ring Binders

50 File Half Cupboard	
A42020	
50 File Half Cupboard with Locks	
A42021	

50 File Cupboard

H2108mm x W858mm x D350mm



Holds:
Boxfiles,
Lever Arch or
Ring Binders

50 Boxfile Cupboard	
A42022	
50 Boxfile Cupboard with Locks	
A42023	

50 File Cupboard

H2108mm x W858mm x D350mm



Holds:
Boxfiles,
Lever Arch or
Ring Binders

50 Boxfile Cupboard	
A42024	
50 Boxfile Cupboard with Locks	
A42025	

10 File Open Unit
H914mm x 440mm x 330mm



Holds:
Boxfiles,
Lever Arch or
Ring Binders

10 File Open Unit	
A41001	

10 File Half Cupboard
H914mm x 440mm x 350mm



Holds:
Boxfiles,
Lever Arch or
Ring Binders

10 File Half Cupboard	
A41002	
10 File Half Cupboard with Lock	
A41003	

10 File Full Cupboard
H914mm x 440mm x 350mm



Holds:
Boxfiles,
Lever Arch or
Ring Binders

10 File Full Cupboard	
A41004	
10 File Full Cupboard with Lock	
A41005	

20 File Open Unit
H914mm x W858mm x D330mm



Holds:
Boxfiles,
Lever Arch or
Ring Binders

20 File Open Unit	
A42001	

20 File Half Cupboard
H914mm x W858mm x D350mm



Holds:
Boxfiles,
Lever Arch or
Ring Binders

20 File Half Cupboard	
A42002	
20 File Half Cupboard with Locks	
A42003	

20 File Full Cupboard
H914mm x W858mm x D350mm



Holds:
Boxfiles,
Lever Arch or
Ring Binders

20 File Full Cupboard	
A42004	
20 File Full Cupboard with Locks	
A42005	

20 File Cupboard
H914mm x W858mm x D350mm



Holds:
Boxfiles,
Lever Arch or
Ring Binders

20 File Cupboard	
A42006	
20 File Cupboard with Lock	
A42026	

30 File Cupboard
H914mm x W1276mm x D330mm



Holds:
Boxfiles,
Lever Arch or
Ring Binders

30 File Open Unit	
A43001	

30 File Cupboard
H914mm x W1276mm x D350mm



Holds:
Boxfiles,
Lever Arch or
Ring Binders

30 File Cupboard	
A43002	
30 File Cupboard with Locks	
A43010	

15 File Open Unit

H1312mm x W440mm x D330mm



*Holds:
Boxfiles,
Lever Arch or
Ring Binders*

15 File Open Unit	
A41006	

15 File Half Cupboard

H1312mm x W440mm x D350mm



*Holds:
Boxfiles,
Lever Arch or
Ring Binders*

15 File Half Cupboard	
A41007	
15 File Half Cupboard with Lock	
A41008	

15 File Cupboard

H1312mm x W440mm x D350mm



*Holds:
Boxfiles,
Lever Arch or
Ring Binders*

15 File Cupboard	
A41009	
15 File Cupboard with Lock	
A41010	

30 File Open Unit

H1312mm x W858mm x D330mm



*Holds:
Boxfiles,
Lever Arch or
Ring Binders*

30 File Open Unit	
A42007	

30 File Half Cupboard

H1312mm x W858mm x D350mm



*Holds:
Boxfiles,
Lever Arch or
Ring Binders*

30 File Half Cupboard	
A42008	
30 File Half Cupboard with Locks	
A42009	

30 File Full Cupboard

H1312mm x W858mm x D350mm



*Holds:
Boxfiles,
Lever Arch or
Ring Binders*

30 File Full Cupboard	
A42010	
30 File Full Cupboard with Locks	
A42011	

30 File Cupboard

H1312mm x W858mm x D350mm



*Holds:
Boxfiles,
Lever Arch or
Ring Binders*

30 File Cupboard	
A42012	
30 File Cupboard with Lock	
A42027	

45 File Open Unit

H1312mm x W1276mm x D330mm



*Holds:
Boxfiles,
Lever Arch or
Ring Binders*

45 File Open Unit	
A43003	

45 File Cupboard

H1312mm x W1276mm x D350mm



*Holds:
Boxfiles,
Lever Arch or
Ring Binders*

45 File Cupboard	
A43004	
45 File Cupboard with Locks	
A43011	

1370mm Primary Height Wooden Lockers



Available in two depths!



One door lockers fitted with two, indestructible coat pegs in a choice of colours.



All lockers fitted with fold back, safety hinges

Connector bolts can be supplied - please ask when ordering.



Choose either Locks, Knobs or Finger Holes

One Door Locker

H1370mm x W300mm x D350 or 450mm

Two Door Locker

H1370mm x W300mm x D350 or 450mm

Three Door Locker

H1370mm x W300mm x D350 or 450mm

Internal shelf & includes 2 x coat pegs



350mm Deep

1 Door Locker + Finger	
A75022	
1 Door Locker + Knob	
A75001	
1 Door Locker + Lock	
A75002	

450mm Deep

1 Door Locker + Finger	
A75023	
1 Door Locker + Knob	
A75007	
1 Door Locker + Lock	
A75008	



350mm Deep

2 Door Locker + Finger	
A75024	
2 Door Locker + Knob	
A75003	
2 Door Locker + Locks	
A75004	

450mm Deep

2 Door Locker + Finger	
A75025	
2 Door Locker + Knob	
A75009	
2 Door Locker + Locks	
A75010	



350mm Deep

3 Door Locker + Finger	
A75026	
3 Door Locker + Knob	
A75005	
3 Door Locker + Locks	
A75006	

450mm Deep

3 Door Locker + Finger	
A75027	
3 Door Locker + Knob	
A75011	
3 Door Locker + Locks	
A75012	



1800mm Secondary / Adult Height Wooden Lockers



Connector bolts can be supplied - please ask when ordering.



Choose either Locks, Knobs or Finger Holes

One Door Locker

H1800mm x W400mm x D400mm



Includes 2 x coat pegs



1 Door Locker + Finger	
A75028	
1 Door Locker + Knob	
A75013	
1 Door Locker + Lock	
A75014	

Two Door Locker

H1800mm x W400mm x D400mm



2 Door Locker + Finger	
A75029	
2 Door Locker + Knob	
A75015	
2 Door Locker + Locks	
A75016	

Three Door Locker

H1800mm x W400mm x D400mm



3 Door Locker + Finger	
A75030	
3 Door Locker + Knob	
A75017	
3 Door Locker + Locks	
A75018	

Four Door Locker

H1800mm x W400mm x D400mm

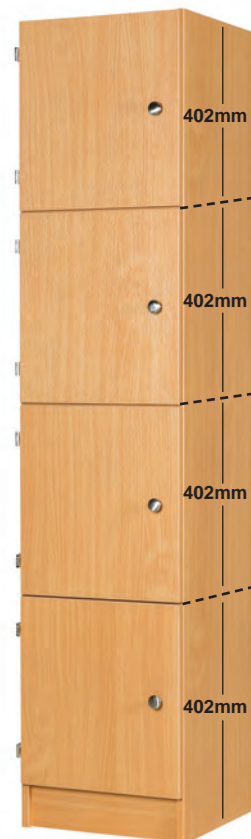

4 Door Locker + Finger	
A75031	
4 Door Locker + Knob	
A75019	
4 Door Locker + Locks	
A75020	

Unbreakable Coathooks - Mounted on a Board

Simply screw the board, complete with coathooks, to your wall!
Wall fixings not supplied.

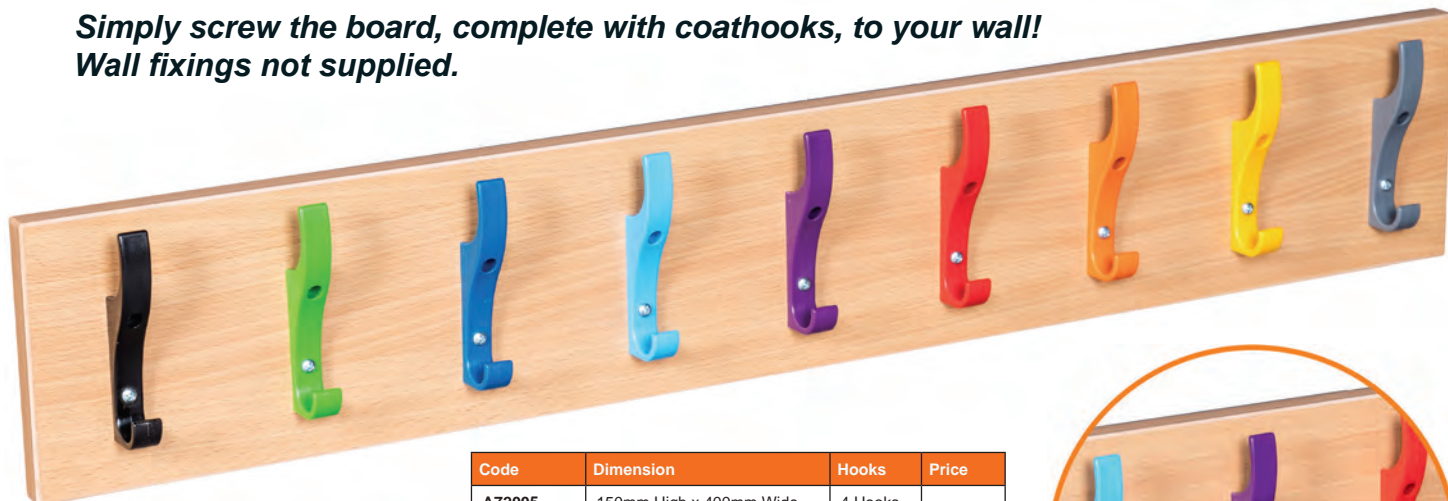

**Indestructible
coathooks!**

Remember to:

- 1 Choose your board colour
- 2 Choose your hook colour

Code	Dimension	Hooks	Price
A72005	150mm High x 400mm Wide	4 Hooks	
A72007	150mm High x 600mm Wide	6 Hooks	
A72009	150mm High x 800mm Wide	8 Hooks	
A72011	150mm High x 1000mm Wide	10 Hooks	
A72012	150mm High x 1200mm Wide	12 Hooks	
A72013	150mm High x 1400mm Wide	14 Hooks	
A72014	150mm High x 1600mm Wide	16 Hooks	
A72015	150mm High x 1800mm Wide	18 Hooks	
A72016	150mm High x 2000mm Wide	20 Hooks	



Choice of board colour finishes



Special sizes can be made to measure - call for details!



Single Sided Static Coat Station
Two heights are available

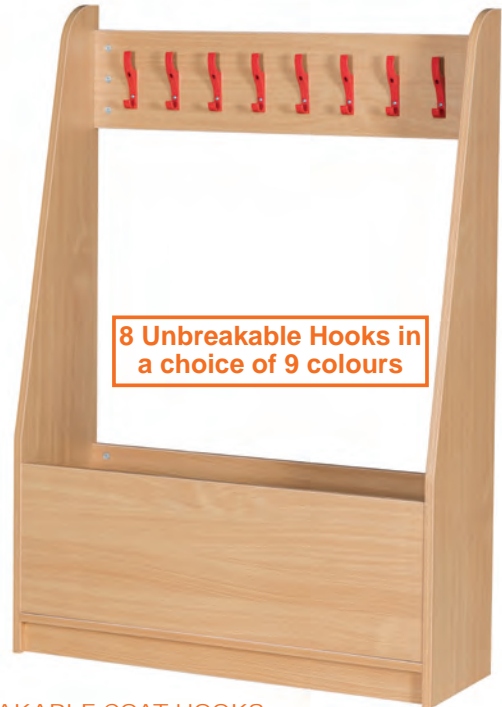

8 Unbreakable Hooks in a choice of 9 colours

Code	Single Sided Static Coat Station	Age	Price
A72001	H1000mm x W915mm D300mm	Under 8	
A72002	H1300mm x W915mm D300mm	Over 8	



Double Sided Mobile Coat Station
Two heights are available

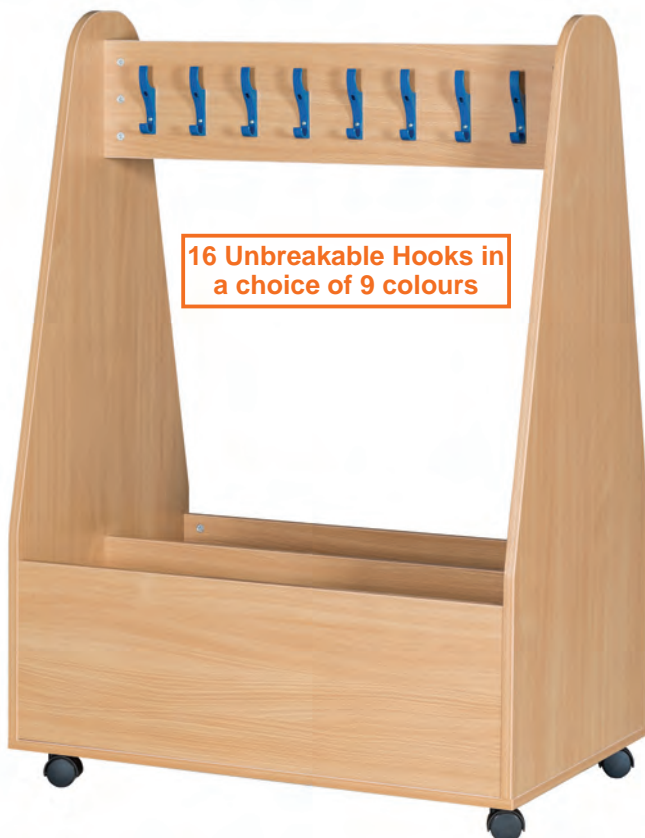

16 Unbreakable Hooks in a choice of 9 colours



Code	Double Sided Mobile Coat Station	Age	Price
A72003	H1000mm x W915mm D600mm	Under 8	
A72004	H1300mm x W915mm D600mm	Over 8	

Uniform Storage

Solid & durable, these tray uniform storage units come complete with all trays. They are available with doors & locks for extra security & have a choice of 5 colour finishes & a choice of tray colours.

Special sizes of these units can be made to measure - call for details!



Choice of Gragnells Tray Colours



6 Tray Uniform Storage

H1674mm x W356mm x D460mm



Code	Static Unit	Price
A11121	H1674mm x W356mm D460mm	
Code	Static Unit with Door	Price
A11122	H1674mm x W356mm D480mm	
Code	Static with Door & Lock	Price
A11123	H1674mm x W356mm D480mm	

12 Tray Uniform Storage

H1674mm x W690mm x D460mm



Code	Static Unit	Price
A12323	H1674mm x W690mm D460mm	
Code	Static Unit with Door	Price
A12324	H1674mm x W690mm D480mm	
Code	Static with Door & Lock	Price
A12325	H1674mm x W690mm D480mm	

18 Tray Uniform Storage

H1674mm x W1024mm x D460mm



Code	Static Unit	Price
A13058	H1674mm x W1024mm D460mm	
Code	Static Unit with Doors	Price
A13059	H1674mm x W1024mm D480mm	
Code	Static with Doors & Locks	Price
A13280	H1674mm x W1024mm D480mm	

4 Space Single Bay Bag Storage

H1390mm x W440mm x D460mm



Code	4 Space Single Bay Bag Holder	Price
A73003	H1390mm x W440mm D460mm	

8 Space Double Bay Bag Storage

H1390mm x W858mm x D460mm



Code	8 Space Double Bay Bag Holder	Price
A73002	H1390mm x W858mm D460mm	



12 Space Triple Bay Bag Storage

H1390mm x W1276mm x D460mm

Special sizes of these units can be made to measure - call for details!



Internal Openings

H300mm x W400mm x D440mm

Choice of five finishes



Code	12 Space Triple Bag Holder	Price
A73001	H1390mm x W1276mm D460mm	

PREMIUM LUNCHBOX TROLLEYS

Premium Lunchbox Trolley

H865mm x W815mm x D360mm



Code	Premium Lunchbox Trolley	Price
A71001	H865mm x W815mm D360mm	

Single Sided Metal Lunchbox Trolley

H1050mm x W900mm x D300mm



Code	Single Sided Metal Lunchbox Trolley	Price
WM001	H1050mm x W900mm D300mm	

Double Sided Metal Lunchbox Trolley

H1050mm x W900mm x D600mm



Code	Double Sided Metal Lunchbox Trolley	Price
WM002	H1050mm x W900mm D600mm	

Outdoor Classroom Trolley



Solid metal construction!

A mobile storage unit, designed to survive the outdoors for your curriculum needs. With a durable, powder coated, steel frame and mounted on strong castors, the trays are angled to give easy access for younger pupils.

Each unit comes with a high quality, rainproof cover that means the units can be left outside all year around if required.

This unit is a must for the 'Outdoors Classroom!'

Code	Outdoor Trolley Only	Price
ODT12	H1000mm x W915mm D300mm	
Code	Outdoor Weatherproof Cover	Price
ODC11	Green Outdoor Storage Cover	

- **Suitable for children of all ages**
- **Durable, solid metal construction**
- **Quality rainproof cover available**
- **Full mobile on lockable castors**



Available with a durable, made-to-measure, weatherproof outdoor cover!





UNBREAKABLE

COAT HOOKS

SOLID BEECH

SLATS & RAILS

All cloakroom units available in 3 seat heights

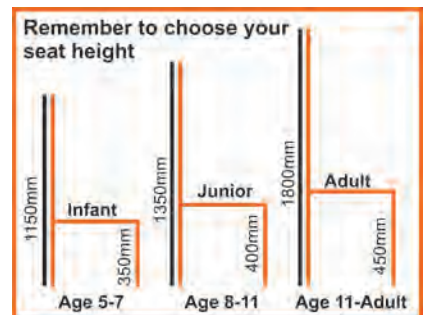
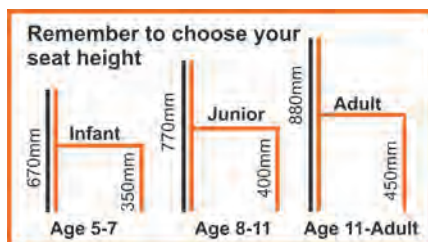
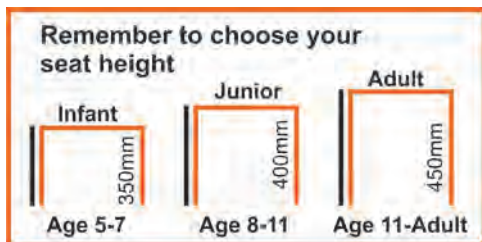

Floor fixing brackets supplied with benches, seats & cloakroom stations



High Quality Coat Hook Rails



Solid beech wood rails fitted with unbreakable coat hooks.



We do not supply wall fixings as we do not know what type of wall you will be fixing your rails to.



600mm 4 Hook Rail



Code	600mm 4 Hook Rail	Price
C72065	Width 600mm	

900mm 7 Hook Rail



Code	900mm 7 Hook Rail	Price
C72066	Width 900mm	

1200mm 9 Hook Rail



Code	1200mm 9 Hook Rail	Price
C72067	Width 1200mm	

1500mm 12 Hook Rail



Code	1500mm 12 Hook Rail	Price
C72068	Width 1500mm	

600mm Single Bench



Code	600mm Single Bench	Price
C72017	W600mm x D355mm	

900mm Single Bench

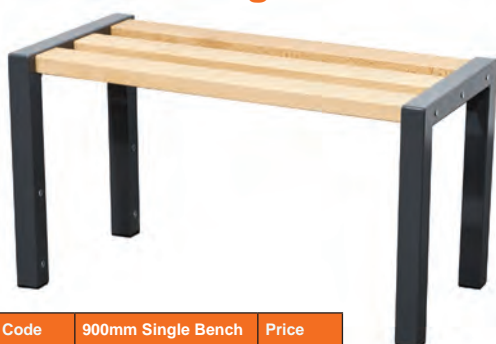

Code	900mm Single Bench	Price
C72018	W900mm x D355mm	

1200mm Single Bench

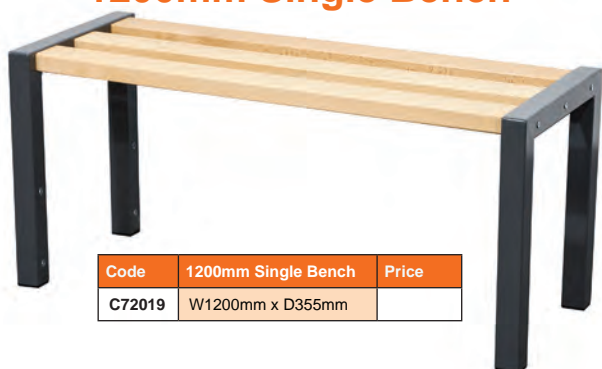

Code	1200mm Single Bench	Price
C72019	W1200mm x D355mm	

1500mm Single Bench

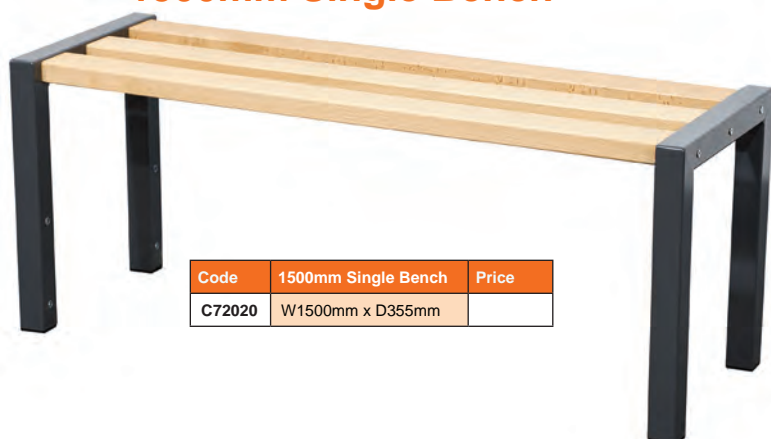

Code	1500mm Single Bench	Price
C72020	W1500mm x D355mm	



Available in 3 heights - 350mm / 400mm / 450mm

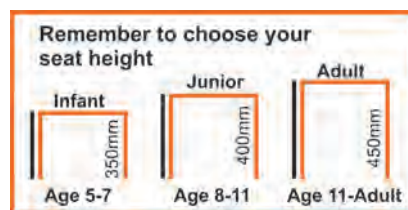

Anti-bacterial coated steel frame in charcoal grey.



All benches supplied with 4 floor fixing brackets.



600mm Single Bench with Shoerack



Code	600mm Single Bench with Shoerack	Price
C72021	W600mm x D355mm	

900mm Single Bench with Shoerack

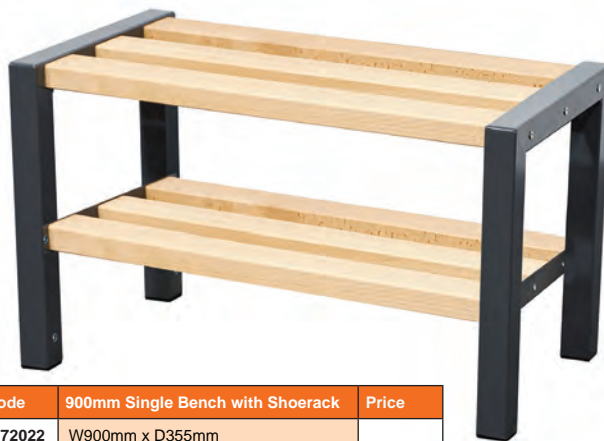

Code	900mm Single Bench with Shoerack	Price
C72022	W900mm x D355mm	

1200mm Single Bench with Shoerack



Code	1200mm Single Bench with Shoerack	Price
C72023	W1200mm x D355mm	

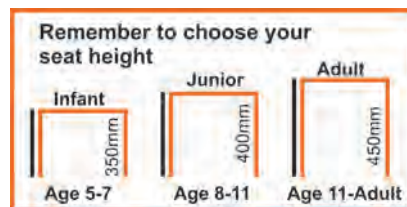

Anti-bacterial coated steel frame in charcoal grey.



All benches supplied with 4 floor fixing brackets.

1500mm Single Bench with Shoerack



Code	1500mm Single Bench with Shoerack	Price
C72024	W1500mm x D355mm	



Available in 3 heights - 350mm / 400mm / 450mm

Solid Ash Slatted Cloakroom Double Benches

600mm Double Bench



Code	600mm Double Bench	Price
C72033	W600mm x D620mm	

900mm Double Bench



Code	900mm Double Bench	Price
C72034	W900mm x D620mm	

1200mm Double Bench



Code	1200mm Double Bench	Price
C72035	W1200mm x D620mm	

Anti-bacterial coated steel frame in charcoal grey.



All benches supplied with 4 floor fixing brackets.

1500mm Double Bench

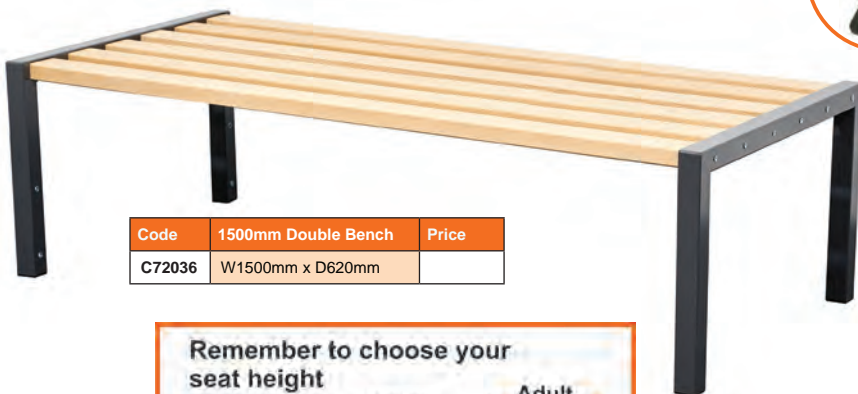

Code	1500mm Double Bench	Price
C72036	W1500mm x D620mm	

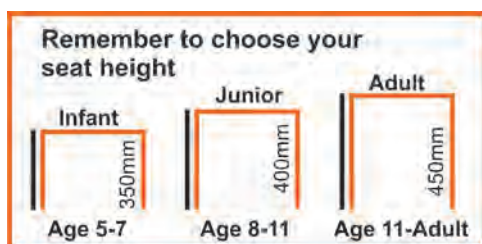

600mm Double Bench with Shoerack



Code	600mm Double Bench with Shoerack	Price
C72037	W600mm x D620mm	

900mm Double Bench with Shoerack



Code	900mm Double Bench with Shoerack	Price
C72038	W900mm x D620mm	

1200mm Double Bench with Shoerack

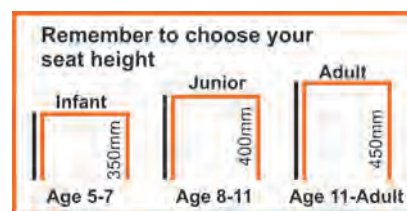
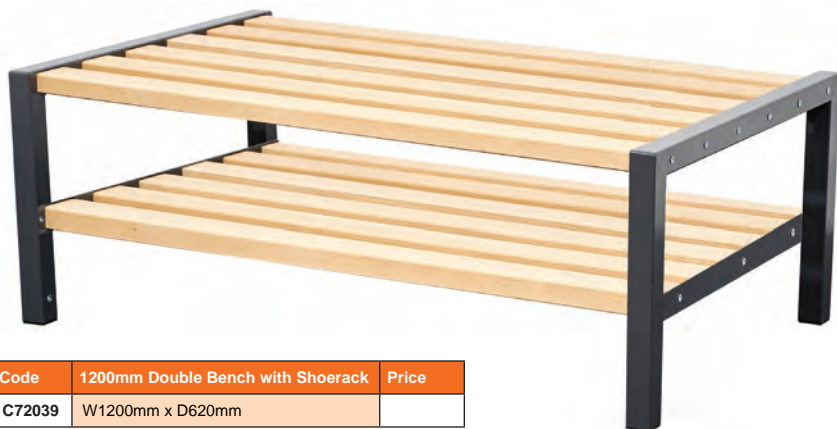

Code	1200mm Double Bench with Shoerack	Price
C72039	W1200mm x D620mm	

Anti-bacterial coated steel frame in charcoal grey.



All benches supplied with 4 floor fixing brackets.

1500mm Double Bench with Shoerack



Code	1500mm Double Bench with Shoerack	Price
C72040	W1500mm x D620mm	

600mm Single Seat



Code	600mm Single Seat	Price
C72025	W600mm x D355mm	



900mm Single Seat

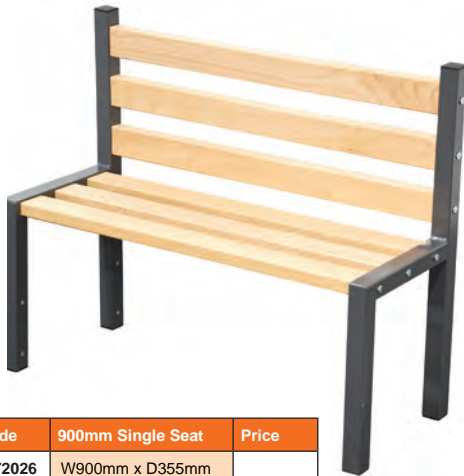

Code	900mm Single Seat	Price
C72026	W900mm x D355mm	

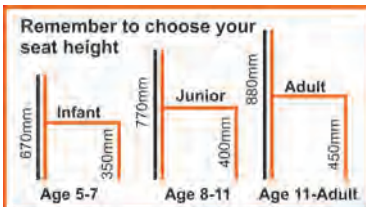

1200mm Single Seat



Code	1200mm Single Seat	Price
C72027	W1200mm x D355mm	



All benches supplied with 4 floor fixing brackets.

1500mm Single Seat



Code	1500mm Single Seat	Price
C72028	W1500mm x D355mm	



600mm Single Seat with Shoe Rack



Code	600mm Single Seat + Shoe Rack	Price
C72029	W600mm x D355mm	

800mm Single Seat with Shoe Rack



Code	900mm Single Seat + Shoe Rack	Price
C72030	W900mm x D355mm	

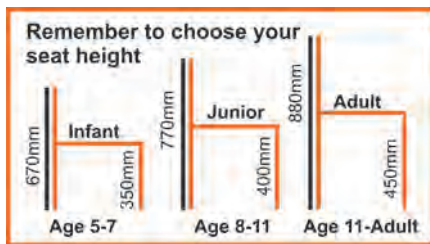

Available in 3 heights - 350mm / 400mm / 450mm

1200mm Single Seat with Shoe Rack



Code	1200mm Single Seat + Shoe Rack	Price
C72031	W1200mm x D355mm	

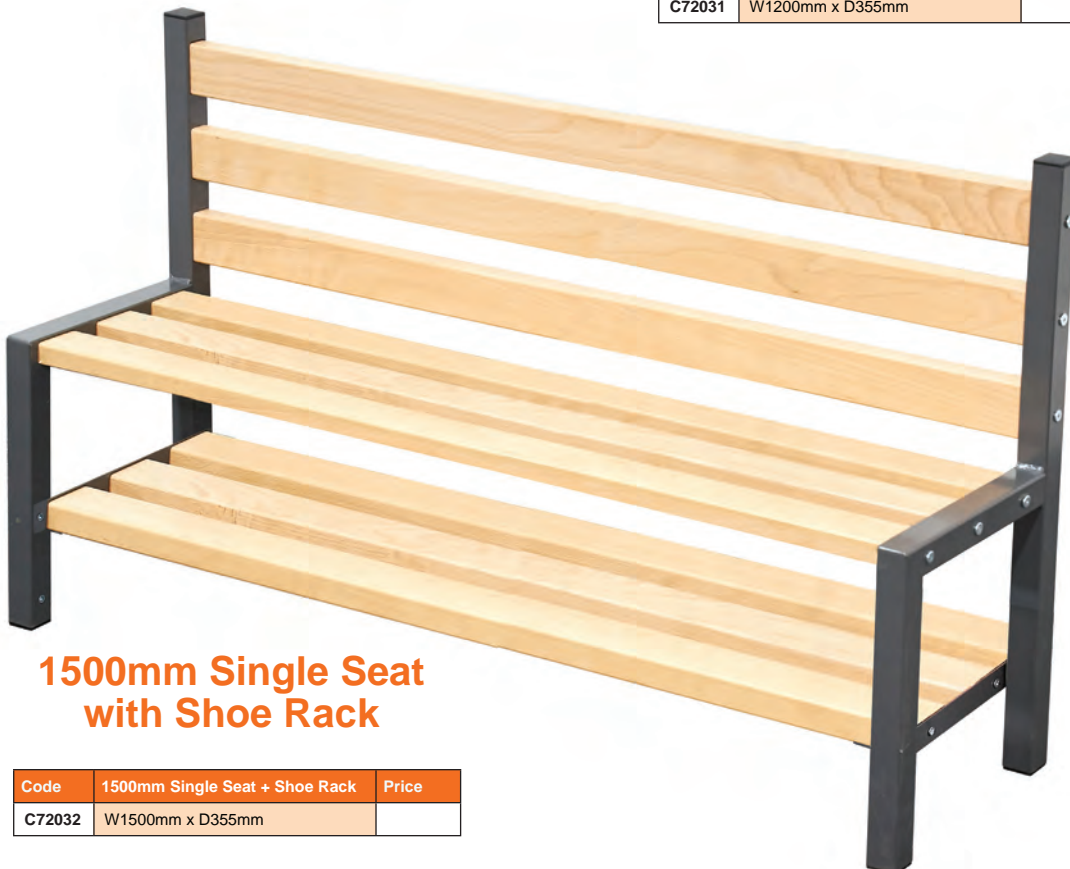

1500mm Single Seat with Shoe Rack

Code	1500mm Single Seat + Shoe Rack	Price
C72032	W1500mm x D355mm	



All benches supplied with 4 floor fixing brackets.

600mm Double Sided Seat



Code	600mm Double Sided Seat	Price
C72041	W600mm x D620mm	

900mm Double Sided Seat



Code	900mm Double Sided Seat	Price
C72042	W900mm x D620mm	



1200mm Double Sided Seat



Code	1200mm Double Sided Seat	Price
C72043	W1200mm x D620mm	

Available in 3 heights - 350mm / 400mm / 450mm



1500mm Double Sided Seat

Code	1500mm Double Sided Seat	Price
C72044	W1500mm x D620mm	

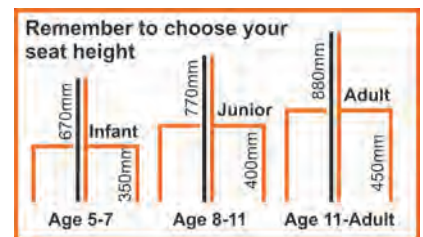

All benches supplied with 4 floor fixing brackets.

600mm Double Sided Seat with Shoe Rack



Code	600mm Double Sided Seat with Shoe Rack	Price
C72045	W600mm x D620mm	

1200mm Double Sided Seat with Shoe Rack



Code	1200mm Double Sided Seat with Shoe Rack	Price
C72047	W1200mm x D620mm	

900mm Double Sided Seat with Shoe Rack



Code	900mm Double Sided Seat with Shoe Rack	Price
C72046	W900mm x D620mm	

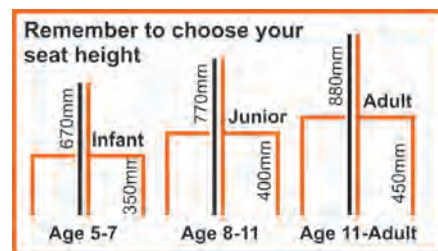

1500mm Double Sided Seat with Shoe Rack

Code	1500mm Double Sided Seat with Shoe Rack	Price
C72048	W1500mm x D620mm	



All benches supplied with 4 floor fixing brackets.

600mm Single Sided Cloakroom



4
HOOK

Code	600mm Single Sided Cloakroom	Hooks	Price
C72049	W600mm x D355mm	4	

1200mm Single Sided Cloakroom



9
HOOK

Code	1200mm Single Sided Cloakroom	Hooks	Price
C72051	W1200mm x D355mm	9	

900mm Single Sided Cloakroom



7
HOOK

Code	900mm Single Sided Cloakroom	Hooks	Price
C72050	W900mm x D355mm	7	

1500mm Single Sided Cloakroom



12
HOOK

All benches supplied with 4 floor fixing brackets.

Code	1500mm Single Sided Cloakroom	Hooks	Price
C72052	W1500mm x D355mm	12	

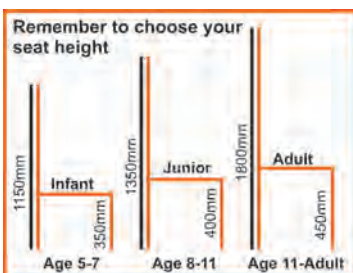

600mm Cloakroom with Shoe Rack



Code	600mm Single Sided with Shoe Rack	Hooks	Price
C72053	W600mm x D355mm	4	



900mm Cloakroom with Shoe Rack



Code	900mm Single Sided with Shoe Rack	Hooks	Price
C72054	W900mm x D355mm	7	

1500mm Cloakroom with Shoe Rack



Code	1500mm Single Sided with Shoe Rack	Hooks	Price
C72056	W1500mm x D355mm	12	

1200mm Cloakroom with Shoe Rack



Code	1200mm Single Sided with Shoe Rack	Hooks	Price
C72055	W1200mm x D355mm	9	



All benches supplied with 4 floor fixing brackets.

600mm Single Station



8
HOOK

Code	600mm Double Sided Station	Hooks	Price
C72057	W600mm x D660mm	8	

900mm Single Station



14
HOOK

Code	900mm Double Sided Station	Hooks	Price
C72058	W900mm x D660mm	14	

1200mm Single Station



18
HOOK

Code	1200mm Double Sided Station	Hooks	Price
C72059	W1200mm x D660mm	18	



1500mm Single Station



24
HOOK

Available in 3 heights - 350mm / 400mm / 450mm

Code	1500mm Double Sided Station	Hooks	Price
C72060	W1500mm x D660mm	24	

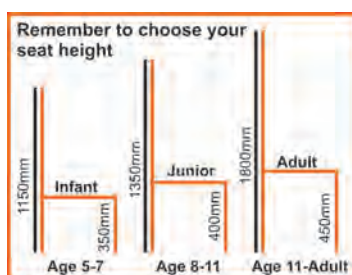

All benches supplied with 4 floor fixing brackets.

600mm Seat with Shoe Rack



Code	600mm Double Sided with Shoe Rack	Hooks	Price
C72061	W600mm x D660mm	8	

1200mm Seat with Shoe Rack



Code	1200mm Double Sided with Shoe Rack	Hooks	Price
C72063	W1200mm x D660mm	18	

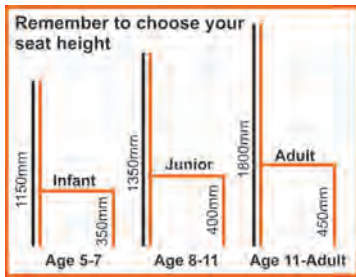

900mm Seat with Shoe Rack



Code	900mm Double Sided with Shoe Rack	Hooks	Price
C72062	W900mm x D660mm	14	

1500mm Seat with Shoe Rack



Code	1500mm Double Sided with Shoe Rack	Hooks	Price
C72064	W1500mm x D660mm	24	



All benches supplied with 4 floor fixing brackets.

Britannia Range Bookcases

The Britannia Range of Bookcases are manufactured in an 18mm solid wood MDF with a bump resistant matching edging. All bookcases feature fully adjustable shelving and are available in 4 styles. Mobile Units feature extra heavy duty wheels for easy movement. The Britannia Range is also available in a choice of 5 Wood finishes. Beech, Maple, Light Oak, Grey & White.

NARROW

900mm High Narrow Bookcase

Width 400mm x Depth 300mm



1 x Adjustable Shelf

900mm High Narrow Bookcase

A65008

1200mm High Narrow Bookcase

Width 400mm x Depth 300mm



2 x Adjustable Shelves

1200mm High Narrow Bookcase

A65009

1500mm High Narrow Bookcase

Width 400mm x Depth 300mm



1 x Fixed Shelf
2 x Adjustable Shelves

1500mm High Narrow Bookcase

A65010

1800mm High Narrow Bookcase

Width 400mm x Depth 300mm



1 x Fixed Shelf
4 x Adjustable Shelves

1800mm High Narrow Bookcase

A65011

DOUBLE SIDED MOBILE

900mm High Mobile Double Sided Bookcase

Width 1000mm x Depth 574mm



1 x Adjustable Shelf each side

900mm High Mobile Double Sided Bookcase

A65005

1200mm High Mobile Double Sided Bookcase

Width 1000mm x Depth 574mm



2 x Adjustable Shelves each side

1200mm High Mobile Double Sided Bookcase

A65006

1500mm High Mobile Double Sided Bookcase

Width 1000mm x Depth 574mm



1 x Fixed Shelf
2 x Adjustable Shelves each side

1500mm High Mobile Double Sided Bookcase

A65007

**1800mm High
1m Wide Bookcase**

Width 1000mm x Depth 300mm



1 x Fixed Shelf
4 x Adjustable Shelves

1800mm High 1m Wide Bookcase
A65015

**1500mm High
1m Wide Bookcase**

Width 1000mm x Depth 300mm



1 x Fixed Shelf
2 x Adjustable Shelves

1500mm High 1m Wide Bookcase
A65014



Choice of finishes



**1200mm High
1m Wide Bookcase**

Width 1000mm x Depth 300mm



3 x Adjustable Shelves

1200mm High 1m Wide Bookcase
A65013

**900mm High
1m Wide Bookcase**

Width 1000mm x Depth 300mm



1 x Adjustable Shelf

900mm High 1m Wide Bookcase
A65012

**1800mm High Double
Sided Bookcase**

Width 1000mm x Depth 574mm



1 x Fixed Shelf
4 x Adjustable Shelves each side

1800mm High D/S Bookcase
A65004

**1500mm High Double
Sided Bookcase**

Width 1000mm x Depth 574mm



1 x Fixed Shelf
2 x Adjustable Shelves each side

1500mm High D/S Bookcase
A65003

**1200mm High Double
Sided Bookcase**

Width 1000mm x Depth 574mm



3 x Adjustable Shelves each side

1200mm High D/S Bookcase
A65002



**900mm High Double
Sided Bookcase**

Width 1000mm x Depth 574mm



2 x Adjustable Shelves each side

900mm High D/S Bookcase
A65001

The Original Kinderbox

H425mm x W610mm x D600mm



The Original Kinderbox	
A63001	

Double Sided Mobile Bookcase

H900mm x W900mm x D460mm



Double Sided Mobile Bookcase	
A63006	

Low Mobile Kinderbox

H300mm x W610mm x D600mm



Low Mobile Kinderbox	
A63002	

Mobile Kinderbox

H465mm x W610mm x D600mm



Mobile Kinderbox	
A63003	

Low Mobile Extra-wide Kinderbox

H300mm x W1200mm x D600mm



Low Mobile Extra-wide Kinderbox	
A63004	

Mobile Extra-wide Kinderbox

H465mm x W1200mm x D600mm



Mobile Extra-wide Kinderbox	
A63005	

Mobile Double Sided Kinder Book Trolley

H900mm x W900mm x D460mm



Choice of Tray Colours

- Blue
- Red
- Yellow
- Green
- Purple
- Lime
- Orange
- Cyan
- Pink
- Blueberry Jelly
- Strawberry Jelly
- Grape Jelly
- Lemon Jelly
- Kiwi Jelly
- Light Grey
- Clear

Choice of finishes

CHOICE OF FINISHES

- MAPLE
- BEECH
- OAK
- GREY
- WHITE

12 Tray Tall Mobile Book Trolley

H900mm x W690mm x D460mm



18 Tray Tall Mobile Book Trolley

H900mm x W1024mm x D460mm



8 Tray Mobile Book Trolley

H671mm x W690mm x D460mm



12 Tray Mobile Book Trolley

H671mm x W1024mm x D460mm



Folio Study Carrel

These solid, high quality carrels help to create individual learning environments. Beech finish available with a choice of edge colours.

Ask if you require **SPECIAL SIZES**



Folio Study Carrel - special sizes are available		
A66001	H1200mm x W750mm x D680mm	



Wave Design Study Carrels

These study carrels create a high quality, individual learning environment. Used in many places within differing types of learning establishments. They can be used as sole learning stations or placed together to create a central study zone.

Solid construction with metal frames, these carrels are available in 3 styles, single or doubles & in heights to suit all age groups - see Age Chart. They are also available with a choice of back panel colours.

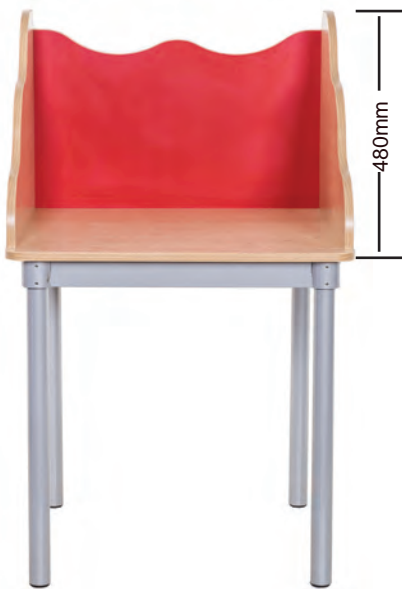

Single Wave Study Carrel - please select required height		
KCSTS3	Width 700mm x Depth 700mm	

Double Wave Study Carrel - please select required height		
KCSTD3	Width 1400mm x Depth 700mm	

Choice of back panel colours for all carrels

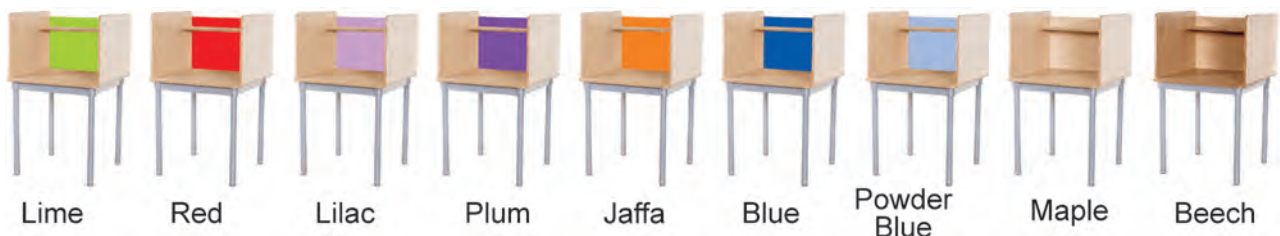

Linking Study Pod

These solid, high quality study pods links together to create safe, cohesive learning spaces that work well with social distancing. Can be placed back to back to form runs or in a square to maximise available space. Manufactured in a durable, Beech laminate finish. **Call for special sizes.**

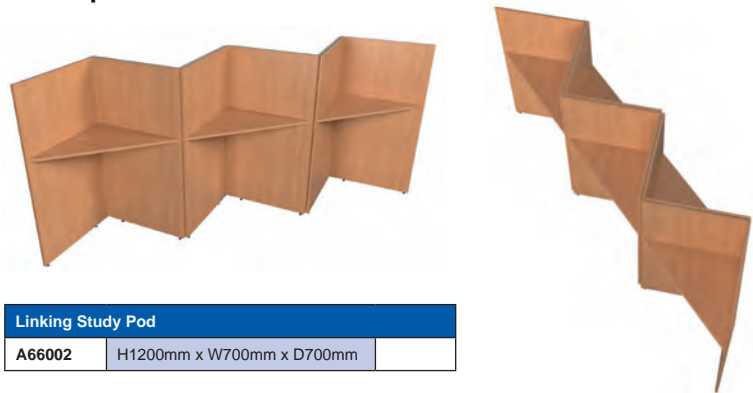
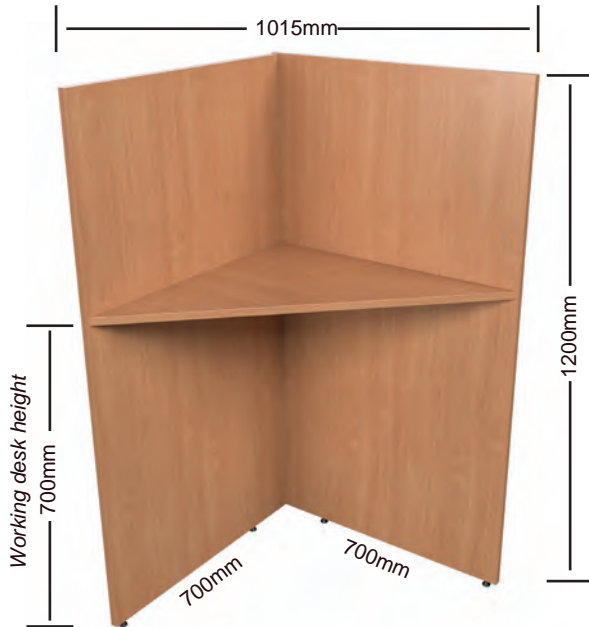

Linking Study Pod	
A66002	H1200mm x W700mm x D700mm

Curve Design Study Carrels



Double Curve Study Carrel - please select required height	
KCSTD1	Width 1400mm x Depth 700mm



Single Curve Study Carrel - please select required height	
KCSTS1	Width 700mm x Depth 700mm

Square Design Study Carrels



Single Square Study Carrel - please select required height	
KCSTS2	Width 700mm x Depth 700mm



Double Square Study Carrel - please select required height	
KCSTD2	Width 1400mm x Depth 700mm

Study Carrels are available in the below heights

E3 Ages 6-8	Desk top height 590mm	Overall Height 1050mm
E4 Ages 8-11	Desk top height 640mm	Overall Height 1100mm
E5 Ages 11-14	Desk top height 710mm	Overall Height 1170mm
E6 Ages 14-Adult	Desk top height 760mm	Overall Height 1220mm



Folio Premium Library Range

Our very popular Folio Range has been updated & improved to a very high standard, using an 18mm solid wood MDF throughout in beech finish with a durable bump resistant edging in a choice of colours.

Creates a stunning & very stylish library that will stand the test of time & will be an attractive addition to any learning environment.

4 simple steps for ordering

- 1 Choose your bookcase style
- 2 Choose your layout
- 3 Choose your height
- 4 Choose your edge colour

Special sizes of bookcases can be made to your requirements
Please call to discuss!

FREE Planning Design Service available



Choice of edge colours



An overview of Folio Premium Library

All available in 5 heights: 750mm, 900mm, 1200mm, 1500mm & 1800mm

Display Bookcases



Library Cupboards



Library Bookcases



Double Sided



DbI Sided Display



Internal Corner



External Corner

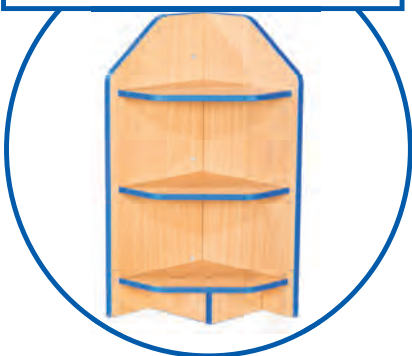

End Cap Bookcase



Blanking Units



Flat Top Bookcases



Book Browsers



Book Benches



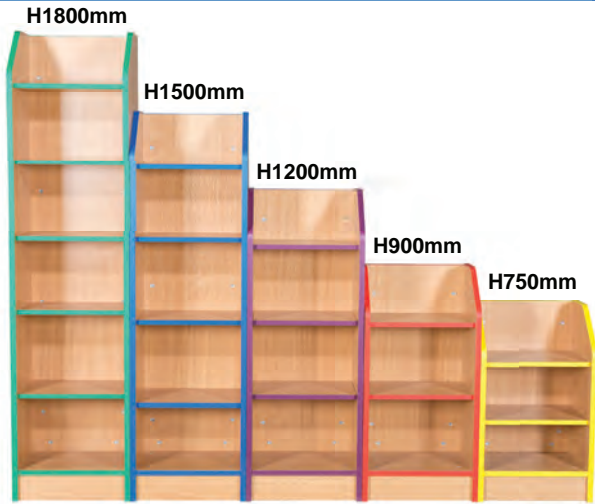

Choice of edge colours
 RED YELLOW BLUE GREEN PLUM BEECH

5 HEIGHTS

750mm - 1800mm

Adjustable Shelves



750mm Wide Library Bookcase with Adjustable Shelves

H750mm x W750mm x D325mm	
A61001	
H900mm x W750mm x D325mm	
A61002	
H1200mm x W750mm x D325mm	
A61003	
H1500mm x W750mm x D325mm	
A61004	
H1800mm x W750mm x D325mm	
A61005	



750mm Wide Library Bookcase with Adjustable Shelves Angled top shelf for face on display

H750mm x W750mm x D325mm	
A61006	
H900mm x W750mm x D325mm	
A61007	
H1200mm x W750mm x D325mm	
A61008	
H1500mm x W750mm x D325mm	
A61009	
H1800mm x W750mm x D325mm	
A61010	



375mm Wide Slimline Bookcase with Adjustable Shelves

H750mm x W375mm x D325mm	
A61011	
H900mm x W375mm x D325mm	
A61012	
H1200mm x W375mm x D325mm	
A61013	
H1500mm x W375mm x D325mm	
A61014	
H1800mm x W375mm x D325mm	
A61015	



750mm Wide Bookcase Cupboard with Adjustable Shelves



H750mm x W750mm x D345mm	
A61016	
H900mm x W750mm x D345mm	
A61017	
H1200mm x W750mm x D345mm	
A61018	
H1500mm x W750mm x D345mm	
A61019	
H1800mm x W750mm x D345mm	
A61020	



750mm x 750mm Internal Corner Bookcase with Adjustable Shelves

To create a continuous run of units around a corner area

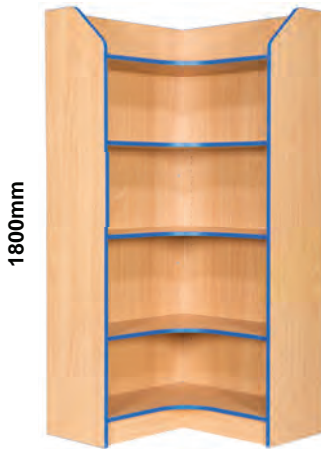

H750mm x W750mm x D750mm	
A61031	
H900mm x W750mm x D750mm	
A61032	
H1200mm x W750mm x D750mm	
A61033	
H1500mm x W750mm x D750mm	
A61034	
H1800mm x W750mm x D750mm	
A61035	

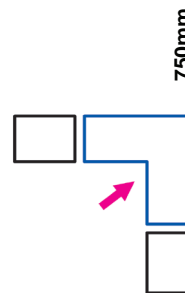

External Fixed Shelf Corner Bookcase

Ideal for ending a run of bookcases or bridging around a corner

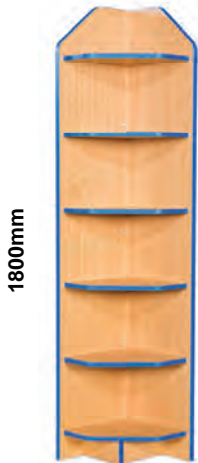

H750mm x W325mm x D325mm	
A61036	
H900mm x W325mm x D325mm	
A61037	
H1200mm x W325mm x D325mm	
A61038	
H1500mm x W325mm x D325mm	
A61039	
H1800mm x W325mm x D325mm	
A61040	

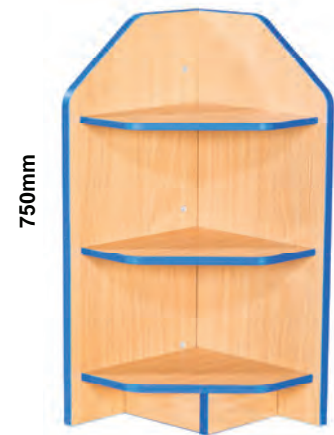
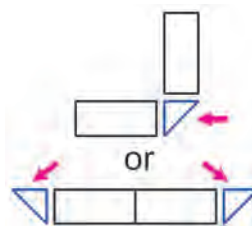

Library Blanking Unit

Used in a run of bookcases. Allows double ended bookcases to be used to create an aisle.

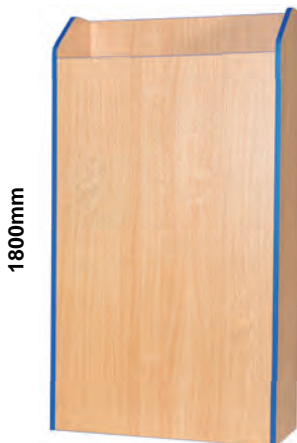

H750mm x W750mm x D325mm	
A61051	
H900mm x W750mm x D325mm	
A61052	
H1200mm x W750mm x D325mm	
A61053	
H1500mm x W750mm x D325mm	
A61054	
H1800mm x W750mm x D325mm	
A61055	

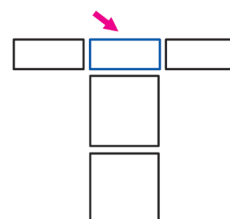



750mm Wide Double Sided Bookcase with Adjustable Shelves

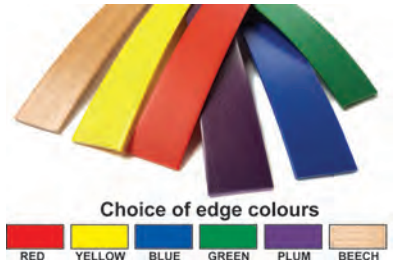
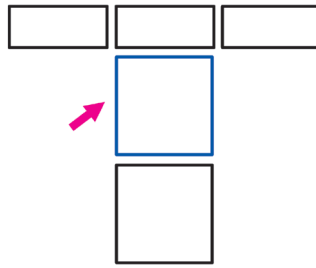

H750mm x W750mm x D650mm	
A61021	
H900mm x W750mm x D650mm	
A61022	
H1200mm x W750mm x D650mm	
A61023	
H1500mm x W750mm x D650mm	
A61024	
H1800mm x W750mm x D650mm	
A61025	



H450mm x W400mm x D325mm



750mm Wide Double Sided Bookcase with Adjustable Shelves

With angled top shelf for face on display

H750mm x W750mm x D650mm	
A61026	
H900mm x W750mm x D650mm	
A61027	
H1200mm x W750mm x D650mm	
A61028	
H1500mm x W750mm x D650mm	
A61029	
H1800mm x W750mm x D650mm	
A61030	



End Cap Fixed Shelf Bookcase

Fits on the end of the double sided bookcase range

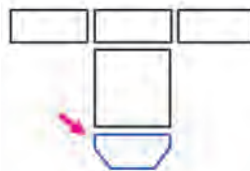

H750mm x W650mm x D325mm	
A61046	
H900mm x W650mm x D325mm	
A61047	
H1200mm x W650mm x D325mm	
A61048	
H1500mm x W650mm x D325mm	
A61049	
H1800mm x W650mm x D325mm	
A61050	

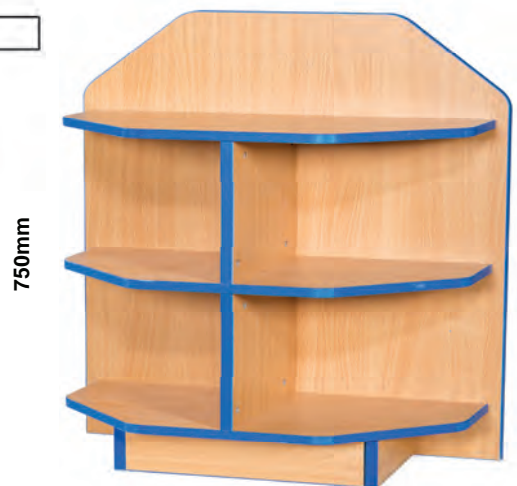

Single Book Storage Bench

H450mm x W400mm x D325mm



Single Book Storage Bench	
A61101	

Double Book Storage Bench

H450mm x W750mm x D325mm



Double Book Storage Bench	
A61102	

Single Book Storage Bench with Cushion

H500mm x W400mm x D325mm



Single Book Storage Bench with Cushion	
A61103	

Double Book Storage Bench with Cushion

H500mm x W750mm x D325mm



Double Book Storage Bench with Cushion	
A61104	

Cushion colour choices

- Blue
- Red
- Green
- Plum

Low Mobile Book Browser

H400mm x W750mm x D500mm



Low Mobile Book Browser	
A61105	

Tall Static Book Browser

H700mm x W750mm x D500mm



Tall Static Book Browser	
A61106	

750mm Wide Flat Top Bookcase with Adjustable Shelves



Choice of edge colours
 RED YELLOW BLUE GREEN PLUM BEECH

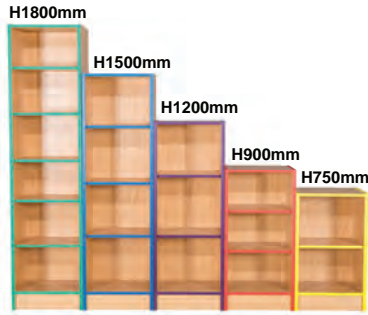

H750mm x W750mm x D325mm	
A61056	
H900mm x W750mm x D325mm	
A61057	
H1200mm x W750mm x D325mm	
A61058	
H1500mm x W750mm x D325mm	
A61059	
H1800mm x W750mm x D325mm	
A61060	



375mm Wide Slimline Flat Top Library Bookcase with Adjustable Shelves



H750mm x W375mm x D325mm	
A61061	
H900mm x W375mm x D325mm	
A61062	
H1200mm x W375mm x D325mm	
A61063	
H1500mm x W375mm x D325mm	
A61064	
H1800mm x W375mm x D325mm	
A61065	

750mm Wide Library Flat Top Bookcase Cupboard with Adjustable Shelves



H750mm x W750mm x D345mm	
A61066	
H900mm x W750mm x D345mm	
A61067	
H1200mm x W750mm x D345mm	
A61068	
H1500mm x W750mm x D345mm	
A61069	
H1800mm x W750mm x D345mm	
A61070	

Flat Top Internal Corner Bookcase with Adjustable Shelves

Need help designing your library?



To create a continuous run of units around a corner area

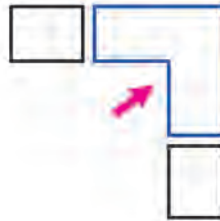

H750mm x W750mm x D750mm	
A61076	
H900mm x W750mm x D750mm	
A61077	
H1200mm x W750mm x D750mm	
A61078	
H1500mm x W750mm x D750mm	
A61079	
H1800mm x W750mm x D750mm	
A61080	



Flat Top External Corner Bookcase with Fixe Shelves

Ideal for ending a run of bookcases or used to go around a corner

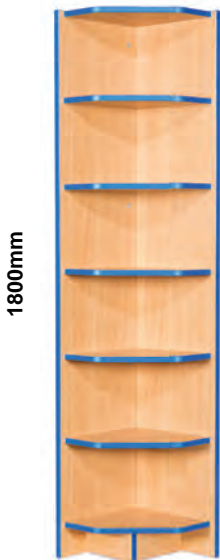

H750mm x W325mm x D325mm	
A61081	
H900mm x W325mm x D325mm	
A61082	
H1200mm x W325mm x D325mm	
A61083	
H1500mm x W325mm x D325mm	
A61084	
H1800mm x W325mm x D325mm	
A61085	

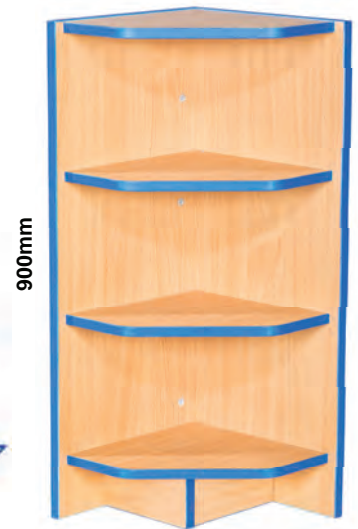
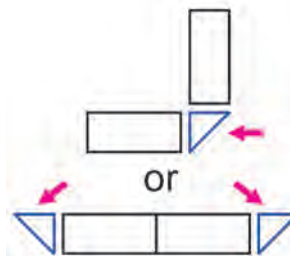

Library Blanking Unit

Used in a run of bookcases. Allows double ended bookcases to be used to create an aisle.



H750mm x W750mm x D325mm	
A61096	
H900mm x W750mm x D325mm	
A61097	
H1200mm x W750mm x D325mm	
A61098	
H1500mm x W750mm x D325mm	
A61099	
H1800mm x W750mm x D325mm	
A61100	

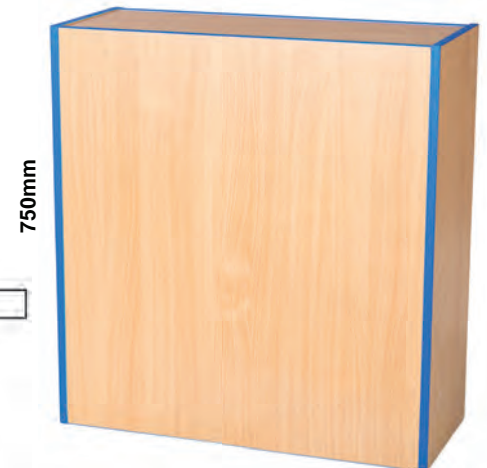
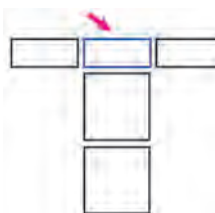

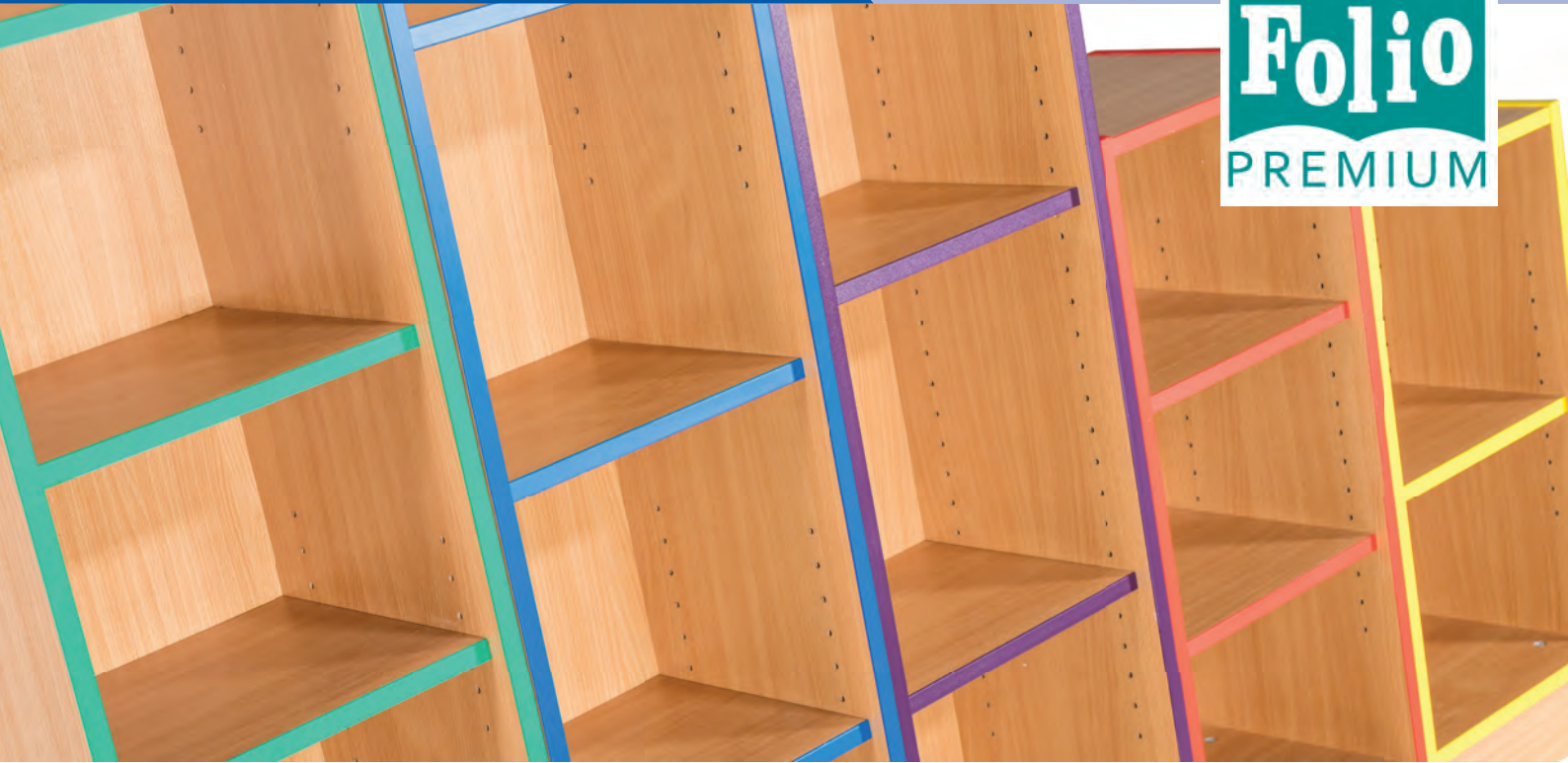

750mm Wide Double Sided Flat Top Bookcase with Adjustable Shelves

H750mm x W750mm x D650mm	
A61071	
H900mm x W750mm x D650mm	
A61072	
H1200mm x W750mm x D650mm	
A61073	
H1500mm x W750mm x D650mm	
A61074	
H1800mm x W750mm x D650mm	
A61075	

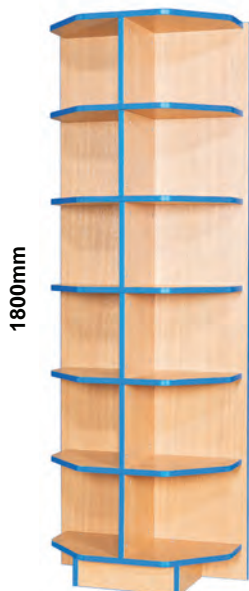

End Cap Flat Top Fixed Shelf Bookcase
Fits on the end of the double sided bookcase range.

H750mm x W650mm x D325mm	
A61091	
H900mm x W650mm x D325mm	
A61092	
H1200mm x W650mm x D325mm	
A61093	
H1500mm x W650mm x D325mm	
A61094	
H1800mm x W650mm x D325mm	
A61095	





KubbyKurve Library

Create your own learning environment with this very popular range of furniture. Solidly built in 18mm MDF Beech wood with a choice of edging colours. This versatile range is great for the library and classroom as well as reception areas.

Units are supplied with chrome connector bolts to link the furniture together.

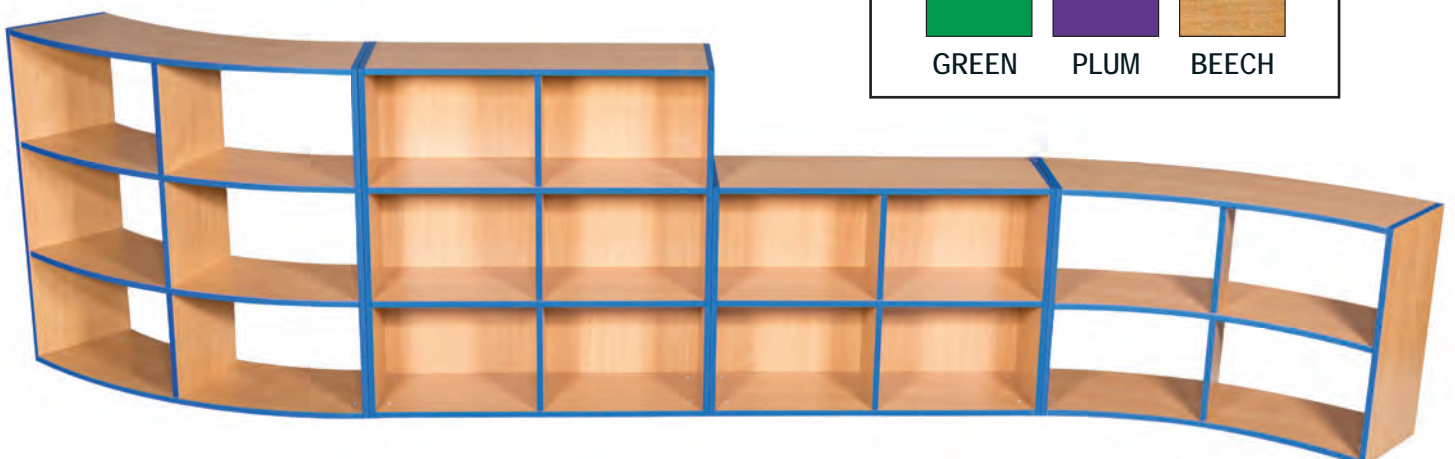
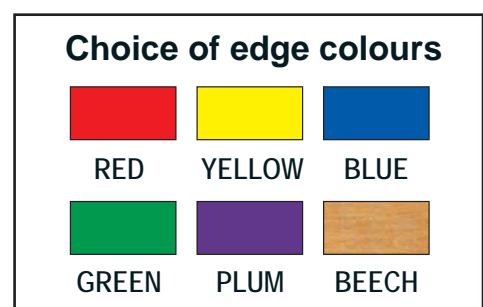

**2 Tier
1+1 Shelf Unit**

H700mm x W500mm x D330mm



2 Tier - 1+1 Shelf Unit	
A62001	

**Two Tier
2+1 Shelf Unit**

H700mm x W500mm x D330mm



2 Tier - 2+1 Shelf Unit	
A62002	

**Two Tier
1+2 Shelf Unit**

H700mm x W500mm x D330mm



2 Tier - 1+2 Shelf Unit	
A62003	

**Two Tier
2+2 Shelf Unit**

H700mm x W500mm x D330mm



2 Tier - 2+2 Shelf Unit	
A62004	

Two Tier - 2+2 Shelf Unit

Height 700mm x Width 1000mm x Depth 330mm



2 Tier - 2+2 Shelf Unit	
A62005	

Two Tier - 2+4 Shelf Unit

Height 700mm x Width 1000mm x Depth 330mm



2 Tier - 2+4 Shelf Unit	
A62006	

Two Tier - 4+2 Shelf Unit

Height 700mm x Width 1000mm x Depth 330mm



2 Tier - 4+2 Shelf Unit	
A62007	

Two Tier - 4+4 Shelf Unit

Height 700mm x Width 1000mm x Depth 330mm



2 Tier - 4+4 Shelf Unit	
A62008	

**Two Tier Curved Open Back
2+2 Shelf Unit**

H700mm x W1200mm x D330mm

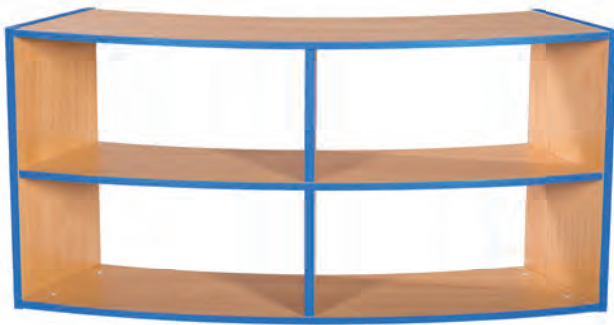

2 Tier Curved Open - 2+2 Shelf Unit	
A62009	

**Three Tier Curved Open Back
2+2+2 Shelf Unit**

H1040mm x W1200mm x D330mm



3 Tier Curved Open - 2+2+2 Shelf Unit	
A62014	

Three Tier - 2+2+2 Shelf Unit

Height 1040mm x Width 1000mm x Depth 330mm



3 Tier - 2+2+2 Shelf Unit	
A62010	

Three Tier - 4+2+2 Shelf Unit

Height 1040mm x Width 1000mm x Depth 330mm



3 Tier - 4+2+2 Shelf Unit	
A62011	

Three Tier - 2+4+4 Shelf Unit

Height 1040mm x Width 1000mm x Depth 330mm



3 Tier - 2+4+4 Shelf Unit	
A62012	

Three Tier - 4+4+4 Shelf Unit

Height 1040mm x Width 1000mm x Depth 330mm



3 Tier - 4+4+4 Shelf Unit	
A62013	

Mobile Storage Cupboard - Locking

H833mm x W1030mm x D477mm



Colore![®]

A vibrant & colourful range that will add fun to any classroom.



Mobile Storage Cupboard

B67009

Bookcase - one adjustable shelf

H600mm x W900mm x D320mm

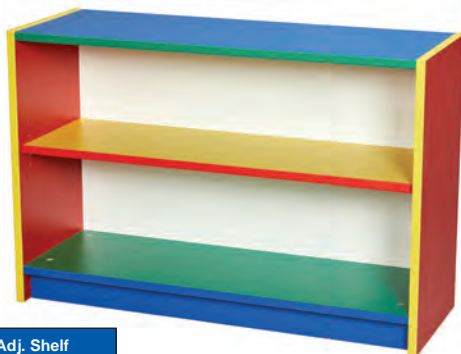

Bookcase - 1 Adj. Shelf

B67003

Bookcase - three adjustable shelves

H1200mm x W900mm x D320mm

Colore![®]



Bookcase - 3 Adj. Shelves

B67005

Bookcase - two adjustable shelves

H800mm x W900mm x D320mm



Bookcase - 2 Adj. Shelves

B67004

4 Bay Mobile Kinderbox

H273mm x W600mm x D600mm



4 Bay Mobile Kinderbox	
B67001	

Mobile Big Book Holder

H760mm x W695mm x D504mm



Mobile Big Book Holder	
B67002	



10Tray Mobile Triple Unit with Shelf

H789mm x W1024mm x D460mm



10 Tray Mobile Unit with Shelf	
B67008	



8 Tray Mobile Double Unit with Shelf

H789mm x W690mm x D460mm



8 Tray Mobile Unit with Shelf	
B67007	



12 Jumbo Tray Mobile Quad Unit

H1107mm x W1358mm x D460mm



12 Jumbo Tray Mobile Quad Unit

B67015

4 Bay 8 Tray Kinderbox

H671mm x W690mm x D460mm



4 Bay 8 Tray Kinderbox Unit

B67006



6 Bay 12 Tray Kinderbox Unit

H671mm x W1024mm x D480mm



6 Bay 12 Tray Kinderbox Unit

B67010



6 Tray Mobile Single Unit

H615mm x W356mm x D460mm



6 Tray Mobile Single Unit

B67011



12 Tray Mobile Double Unit

H615mm x W690mm x D460mm



12 Tray Mobile Double Unit

B67012

18 Tray Mobile Triple Unit

H615mm x W1024mm x D460mm



18 Tray Mobile Triple Unit

B67013



24 Tray Mobile Triple Unit

H779mm x W1024mm x D460mm



24 Tray Mobile Triple Unit

B67014



ACCENTO RANGE

Accento is an attractive range of furniture manufactured in a beech finish with a choice of Red, Blue or Green edging.



Width 900mm x Depth 320mm

Above: 1800mm has 1 x Fixed Shelf & 4 x Adjustable Shelves.



750mm High



1000mm High



1250mm High



1500mm High

Accento Adjustable Bookcases - Red			
B65022ER	750mm High	1 Shelf	
B65025ER	1000mm High	2 Shelves	
B65023ER	1250mm High	3 Shelves	
B65026ER	1500mm High	3 Shelves	
B65024ER	1800mm High	5 Shelves	



Accento Adjustable Bookcases - Blue			
B65022EB	750mm High	1 Adj.Shelf	
B65025EB	1000mm High	2 Adj. Shelves	
B65023EB	1250mm High	3 Adj. Shelves	
B65026EB	1500mm High	3 Adj. Shelves	
B65024EB	1800mm High	1 Fixed - 4 Adj.	



750mm High



1000mm High



1250mm High



1500mm High



Accento Adjustable Bookcases - Green			
B65022EG	750mm High	1 Adj. Shelf	
B65025EG	1000mm High	2 Adj.Shelves	
B65023EG	1250mm High	3 Adj. Shelves	
B65026EG	1500mm High	3 Adj.Shelves	
B65024EG	1800mm High	1 Fixed - 4 Adj.	



750mm High



1000mm High



1250mm High



1500mm High

750mm High Lockable Cupboard

H750mm x W1000mm x D480mm



750mm High Lockable Cupboard		
B23101ER	Red	
B23101EB	Blue	
B23101EG	Green	



1000mm High Lockable Cupboard

H1000mm x W1000mm x D480mm



1000mm High Lockable Cupboard		
B23104ER	Red	
B23104EB	Blue	
B23104EG	Green	

1250mm High Lockable Cupboard

Width 1000mm x Depth 480mm



One Fixed Shelf & Two adjustable shelves

1250mm High Lockable Cupboard		
B23102ER	Red	
B23102EB	Blue	
B23102EG	Green	

1500mm High Lockable Cupboard

Width 1000mm x Depth 480mm



One Fixed Shelf & Two adjustable shelves

1500mm High Lockable Cupboard		
B23105ER	Red	
B23105EB	Blue	
B23105EG	Green	

1800mm High Lockable Cupboard

H1800mm x W1000mm x D480mm



1800mm High Lockable Cupboard		
B23103ER	Red	
B23103EB	Blue	
B23103EG	Green	

8 Jumbo Tray Mobile Quad Unit

H779mm x W1358mm x D460mm



8 Jumbo Tray Mobile Quad Unit		
B14205ER	Red	
B14205EB	Blue	
B14205EG	Green	



12 Jumbo Tray Mobile Quad Unit

H1107mm x W1358mm x D460mm



12 Jumbo Tray Mobile Quad Unit		
B14055ER	Red	
B14055EB	Blue	
B14055EG	Green	

6 Tray Mobile Triple Unit

H615mm x W356mm x D460mm



12 Tray Mobile Triple Unit

H615mm x W692mm x D460mm



6 Tray Mobile Double Units		
B11007ER	Red	
B11007EB	Blue	
B11007EG	Green	

12 Tray Mobile Double Units		
B12007ER	Red	
B12007EB	Blue	
B12007EG	Green	

18 Tray Mobile Triple Unit - Red

H615mm x W1024mm x D460mm



18 Jumbo Tray Mobile Quad Unit		
B13007ER	Red	
B13007EB	Blue	
B13007EG	Green	

Gratnells Tray Colours



SAVE MONEY & SPEND YOUR BUDGET WISELY

We have now made all of our premium tray units available to purchase without trays, saving your school money.

Many schools replace their tray units simply because the outer carcass has become damaged or unsightly, whilst the plastic trays are still perfectly usable.



When you see this logo throughout our catalogue that is the amount you will save by reusing your existing trays.

Simply deduct that amount from the unit price when purchasing and add (E) to the end of the code.

Example: A11007(E) = 6 tray unit, supplied empty.

See how much you can save - remember to look for the logo!

Mix & Match tray depths to suit your requirements

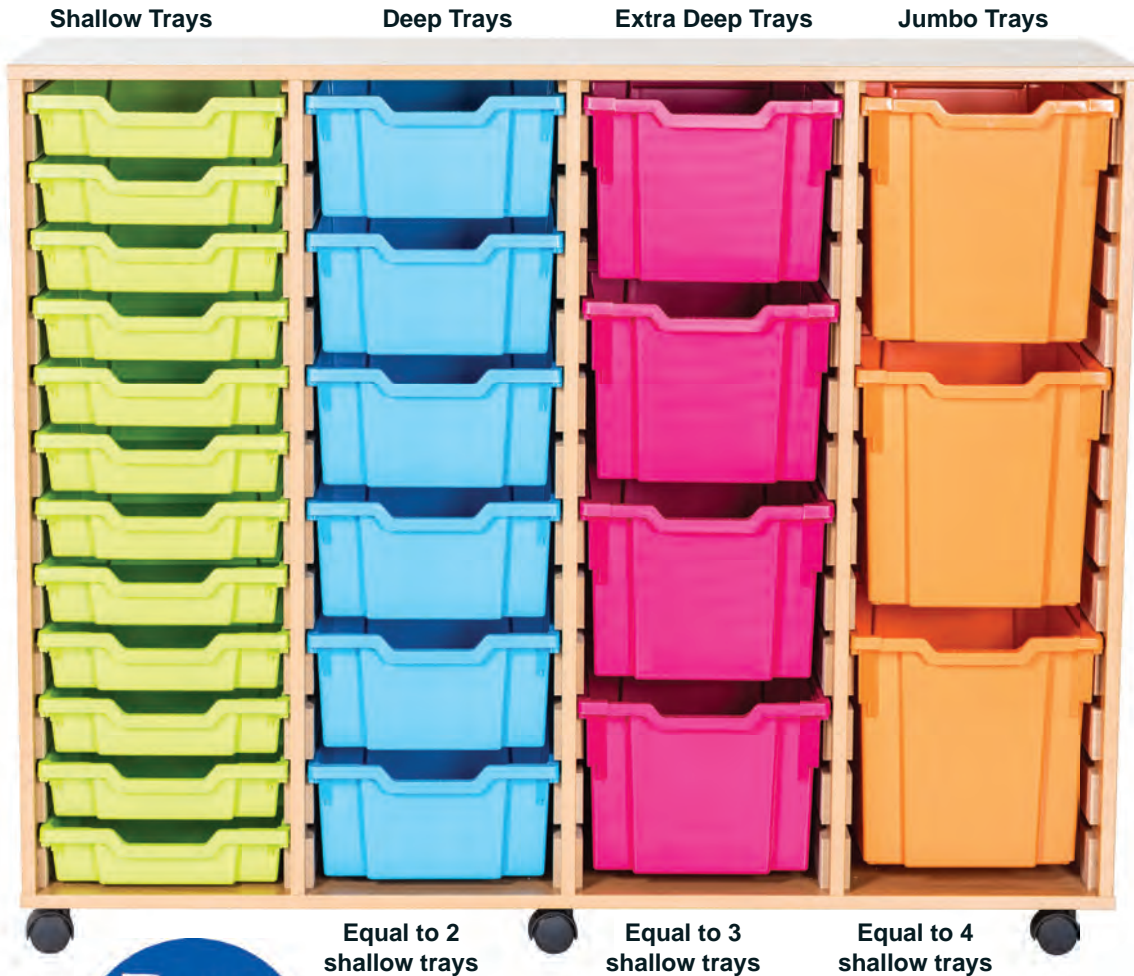

Trays made simple!

Gratnells Trays

See opposite for tray colour guide

Code	Shallow Trays	Price
A4TR	H75mm x W312mm x D427mm	
Code	Deep Trays - Two time deeper	Price
X2TR	H150mm x W312mm x D427mm	

Code	Extra Deep - Three times deeper	Price
X3TR	H225mm x W312mm x D427mm	
Code	Jumbo Trays - Four times deeper	Price
X4TR	H300mm x W312mm x D427mm	

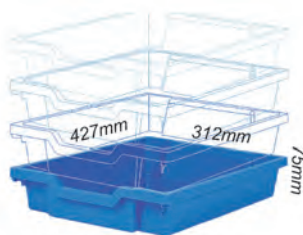

Shallow
(F1) (X1)

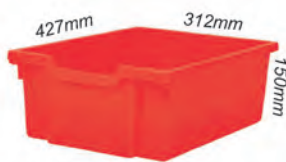

Deep
(F2) (X2)
twice as deep



Extra Deep
(F25) (X3)
3 times as deep



Jumbo
(F3) (X4)
4 times as deep

Gratnells Cubby Trays

Available in Clear Only

Code	Shallow Cubby Trays	Price
TRJS1	H75mm x W260mm x D312mm	
Code	Deep Cubby Trays	Price
TRJS2	H150mm x W260mm x D312mm	
Code	Wide Cubby Trays	Price
TRNS2	H150mm x W377mm x D312mm	

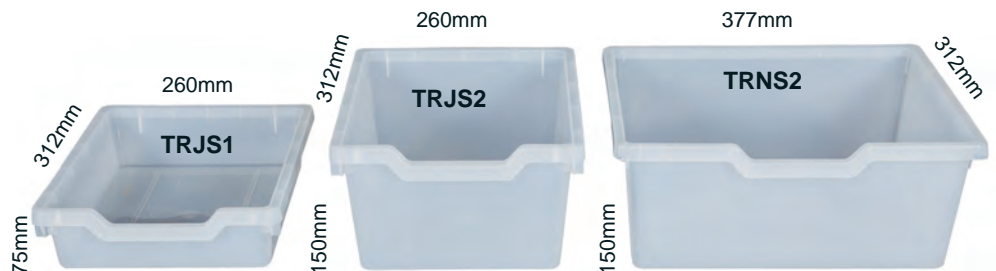

Gratnells Cubby Trays are smaller than standard sizes.

5 Shallow Tray Single

H650mm x W312mm x D350mm

Cubby are small trays



5 Shallow Tray Single Unit
A15001

10 Shallow Tray Double

H650mm x W602mm x D350mm



10 Shallow Tray Double Unit
A15003

15 Shallow Tray Triple

H650mm x W892mm x D350mm



15 Shallow Tray Triple Unit
A15021

9 Shallow Tray Triple

H460mm x W892mm x D350mm

Cubby are small trays

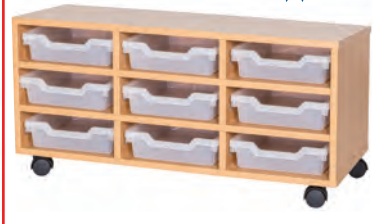

9 Shallow Tray Triple Unit
A15020

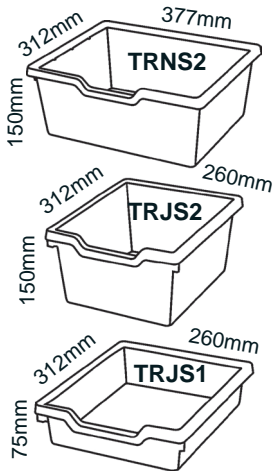

6 Wide Tray Double

H650mm x W834mm x D350mm



6 Wide Tray Double Unit
A15028

8 Wide Tray Double

H800mm x W834mm x D350mm



8 Wide Tray Double Unit
A15027

6 Deep Tray Triple

H460mm x W892mm x D350mm

Cubby are small trays



6 Deep Tray Triple Unit
A15010

3 Deep Tray Single

H650mm x W312mm x D350mm

Cubby are small trays



3 Deep Tray Single Unit
A15006

6 Deep Tray Double

H650mm x W602mm x D350mm



6 Deep Tray Double Unit
A15012

3 Deep 3 Wide Double

H650mm x W719mm x D350mm



Smaller than standard trays

3 Deep - 3 Cubby Tray Triple
A15026

9 Deep Tray Triple

H650mm x W892mm x D350mm



9 Deep Tray Triple Unit
A15013

4 Deep Tray Single

H800mm x W312mm x D350mm

Cubby are small trays



4 Deep Tray Single Unit
A15007

8 Deep Tray Double

H800mm x W602mm x D350mm



6 Deep Tray Double Unit
A15015

4 Deep 4 Wide Double

H800mm x W719mm x D350mm



4 Deep - 4 Wide Tray Triple
A15008

12 Deep Tray Triple

H800mm x W892mm x D350mm



12 Deep Tray Triple Unit
A15016

6 Shallow Tray Single

H800mm x W312mm x D350mm



Smaller than standard trays

6 Shallow Tray Single Unit
A15002

12 Shallow Tray Double

H800mm x W602mm x D350mm



12 Shallow Tray Double Unit
A15022

18 Shallow Tray Triple

H800mm x W892mm x D350mm



18 Shallow Tray Triple Unit
A15023

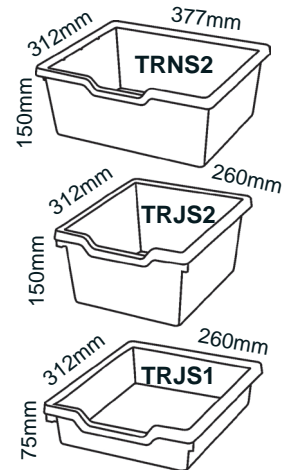

8 Deep Tray Quad Unit

H460mm x W1182mm x D350mm

Cubby are small trays



8 Deep Tray Quad Unit
A15011

4 Wide - 2 Deep Tray Triple

H460mm x W1119mm x D350mm

Smaller than standard trays



4 Wide - 2 Deep Tray Triple
A15024

4 Wide 6 Shallow Quad

H460mm x W1182mm x D350mm



Cubby are small trays

4 Wide 6 Shallow Tray Quad
A15004

12 Deep Tray Quad

H650mm x W1182mm x D350mm



12 Deep Tray Quad Unit
A15014

6 Wide 3 Deep Triple

H650mm x W1119mm x D350mm



4 Wide - 3 Deep Tray Triple
A15009

6 Deep 10 Shallow Quad

H650mm x W1182mm x D350mm



Cubby are small trays

6 Deep - 10 Shallow Quad Unit
A15005

16 Deep Tray Quad

H800mm x W1182mm x D350mm



Smaller than standard trays

16 Deep Tray Quad Unit
A15017

8 Wide 4 Deep Triple

H800mm x W1119mm x D350mm



8 Wide - 4 Deep Tray Triple
A15025

8 Deep 12 Shallow Quad

H800mm x W1182mm x D350mm



8 Deep - 12 Shallow Tray Quad
A15018

PREMIUM TRAY STORAGE

5 Tray Single

H533mm x W356mm x D460mm



Mobile Unit	Mobile + Doors	Mobile + Doors/Locks
A11001	A11002	A11003
Static Unit	Static + Doors	Static + Doors/Locks
A11004	A11005	A11006

10 Tray Double

H533mm x W690mm x D460mm



Mobile Unit	Mobile + Doors	Mobile+Drs/Lock
A12001	A12002	A12003
Static Unit	Static + Doors	Static+Drs/Lock
A12004	A12005	A12006

15 Tray Triple

H533mm x W1024mm x D460mm



Mobile Unit	Mobile + Doors	Mobile+Drs/Locks
A13001	A13002	A13003
Static Unit	Static + Doors	Static+Drs/Locks
A13004	A13005	A13006

5 High Single Open Shelf

H533mm x W356mm x D460mm



Mobile Unit	Static Unit
A21013	A21016

5 High Double Open Shelf

H533mm x W690mm x D460mm



Mobile Unit	Static Unit
A22013	A22016

5 High Triple Open Shelf

H533mm x W1024mm x D460mm



Mobile Unit	Static Unit
A23035	A23038

5 High Single Cupboard

H533mm x W356mm x D480mm



Mobile + Doors	Mobile + Doors/Locks
A21014	A21015
Static + Doors	Static + Doors/Locks
A21017	A21018

5 High Double Cupboard

H533mm x W690mm x D480mm



Mobile + Doors	Mobile + Doors/Locks
A22014	A22015
Static + Doors	Static + Doors/Locks
A22017	A22018

5 High + Shelf Double

H533mm x W690mm x D460mm



Mobile Unit	Mobile + Door	Mobile+Door/Lock
A12125	A12126	A12127
Static Unit	Static + Door	Static+Door/Lock
A12128	A12129	A12130

5 High 10 Tray Triple with Shelf

H533mm x W1024mm x D460mm



FROM
£188

SAVE
£16.00

Mobile Unit		Mobile + Doors		Mobile + Doors/Locks	
A13300	£188.00	A13301	£219.50	A13302	£240.50
Static Unit		Static + Doors		Static + Doors/Locks	
A13303	£188.00	A13304	£219.50	A13305	£240.50

5 High 10 Tray Quad with Shelf

H533mm x W1358mm x D460mm



FROM
£230

SAVE
£16.00

Mobile Unit		Mobile + Doors		Mobile + Doors/Locks	
A14163	£230.00	A14164	£282.50	A14165	£303.50
Static Unit		Static + Doors		Static + Doors/Locks	
A14166	£230.00	A14167	£282.50	A14168	£303.50

20 Tray Quad

H533mm x W1358mm x D460mm



Mobile Unit		Mobile + Doors		Mobile + Doors/Locks	
A14001		A14002		A14003	
Static Unit		Static + Doors		Static + Doors/Locks	
A14004		A14005		A14006	

SAVE
£££'S

5 High 5 Tray Triple with Shelf & Doors

H533mm x W1024mm x D480mm



Mobile + Doors		Mobile + Doors/Locks	
A13307		A13308	
Static + Doors		Static + Doors/Locks	
A13310		A13311	

SAVE
£££'S

5 High Open Fixed Shelf Quad Unit

H533mm x W1358mm x D460mm



Mobile Unit		Static Unit	
A14175		A14180	

5 High 10 Tray Quad Unit with Shelf

H533mm x W1358mm x D460mm



Mobile Unit		Mobile + Doors		Mobile + Doors/Locks	
A14169	£230.00	A14170	£282.50	A14171	£303.50
Static Unit		Static + Doors		Static + Doors/Locks	
A14172		A14173		A14174	

SAVE
£££'S

5 High Triple Cupboard with Shelf

H533mm x W1024mm x D480mm



Mobile + Doors		Mobile + Doors/Locks	
A23036		A23037	
Static + Doors		Static + Doors/Locks	
A23039		A23040	

5 High 5 Tray Triple Unit with Shelf

H533mm x W1024mm x D460mm



Optional door covers trays only

Mobile Unit		Mobile + Door		Mobile + Door/Lock	
A13128		A13129		A13130	
Static Unit		Static + Door		Static + Door/Lock	
A13131		A13132		A13133	

SAVE
£££'S

6 High Single 6 Tray Unit

H615mm x W356mm x D460mm



Mobile Unit	Mobile + Door	Mobile + Door/Lock
A11007	A11008	A11009
Static Unit	Static + Door	Static + Door/Lock
A11010	A11011	A11012

6 High Single 3 Deep Trays

H615mm x W356mm x D460mm



Mobile Unit	Mobile + Door	Mobile + Door/Lock
A11055	A11056	A11057
Static Unit	Static + Door	Static + Door/Lock
A11058	A11059	A11060

6 High Single 2 Extra Deep Trays

H615mm x W356mm x D460mm



Mobile Unit	Mobile + Door	Mobile + Door/Lock
A11061	A11062	A11063
Static Unit	Static + Door	Static + Door/Lock
A11064	A11065	A11066

6 High Single Open Shelf Unit

H615mm x W356mm x D460mm



Mobile Unit	Static Unit
A21001	A21002

6 High Double Open Shelf Unit

H615mm x W690mm x D460mm



Mobile Unit	Static Unit
A22001	A22002

6 High Single Cupboard

H615mm x W356mm x D480mm



Mobile Cupboard	Mobile Cup + Lock	Static Cupboard	Static Cup + Lock
A21003	A21004	A21005	A21006

6 High Double Cupboard

H615mm x W690mm x D480mm



Mobile Cupboard	Mobile Cup + Lock	Static Cupboard	Static Cup + Lock
A22003	A22004	A22005	A22006

6 High 12 Tray Double Unit

H615mm x W690mm x D460mm



Mobile Unit	Mobile + Doors	Mobile + Doors/Locks
A12007	A12008	A12009
Static Unit	Static + Doors	Static + Doors/Locks
A12010	A12011	A12012

6 High 6 Deep Tray Double Unit

H615mm x W690mm x D460mm



Mobile Unit	Mobile + Doors	Mobile+Drs/Locks
A12060	A12061	A12062
Static Unit	Static + Doors	Static+Drs/Locks
A12063	A12064	A12065

6 High 4 Extra Deep Tray Double

H615mm x W690mm x D460mm



Mobile Unit	Mobile + Doors	Mobile+Drs/Locks
A12058	A12066	A12067
Static Unit	Static + Doors	Static+Drs/Locks
A12068	A12069	A12070

6 High 6 Tray Double + Shelf

H615mm x W690mm x D460mm



Mobile Unit	Mobile + Doors	Mobile+Drs/Locks
A12101	A12102	A12103
Static Unit	Static + Doors	Static+Drs/Locks
A12104	A12105	A12106

6 High 6 Deep Tray Double

H615mm x W690mm x D460mm



Mobile Unit	Mobile + Doors	Mobile+Drs/Locks
A12095	A12096	A12097
Static Unit	Static + Doors	Static+Drs/Locks
A12098	A12099	A12100

6 High 4 Extra Deep Tray Double

H615mm x W690mm x D460mm



Mobile Unit	Mobile + Doors	Mobile+Drs/Locks
A12089	A12090	A12091
Static Unit	Static + Doors	Static+Drs/Locks
A12092	A12093	A12094

6 High Combination Double

H615mm x W690mm x D460mm



3 x Deep Trays
2 x Extra Deep Trays

Mobile Unit	Mobile + Doors	Mobile+Drs/Locks
A12083	A12084	A12085
Static Unit	Static + Doors	Static+Drs/Locks
A12086	A12087	A12088

6 High Combination Double

H615mm x W690mm x D460mm



6 x Shallow Trays
3 x Deep Trays

Mobile Unit	Mobile + Doors	Mobile+Drs/Locks
A12071	A12072	A12073
Static Unit	Static + Doors	Static+Drs/Locks
A12074	A12075	A12076

6 High Combination Double

H615mm x W690mm x D460mm



2 x Extra Deep Trays
6 x Shallow Trays

Mobile Unit	Mobile + Doors	Mobile+Drs/Locks
A12077	A12078	A12079
Static Unit	Static + Doors	Static+Drs/Locks
A12080	A12081	A12082

6 High 18 Tray Triple Tray Unit

H615mm x W1024mm x D460mm



Mobile Unit		Mobile + Doors		Mobile + Doors/Locks	
A13007		A13008		A13009	
Static Unit		Static + Doors		Static + Doors/Locks	
A13010		A13011		A13012	

6 High 6 Tray Triple with Cupboards

H615mm x W1024mm x D480mm



Mobile + Doors		Mobile + Doors/Locks	
A13096		A13097	
Static + Doors		Static + Doors/Locks	
A13098		A13099	



6 High 12 Tray Triple with Shelf

H615mm x W1024mm x D460mm



Mobile Unit		Mobile + Doors		Mobile + Doors/Locks	
A13100		A13101		A13102	
Static Unit		Static + Doors		Static + Doors/Locks	
A13103		A13104		A13105	



6 High 6 Tray Triple with Shelf

H615mm x W1024mm x D460mm



Optional door covers trays only

Mobile Unit		Mobile + Door		Mobile + Door/Lock	
A13073		A13074		A13075	
Static Unit		Static + Door		Static + Door/Lock	
A13076		A13077		A13078	



6 High 6 Deep Tray Triple with Shelf

H615mm x W1024mm x D460mm

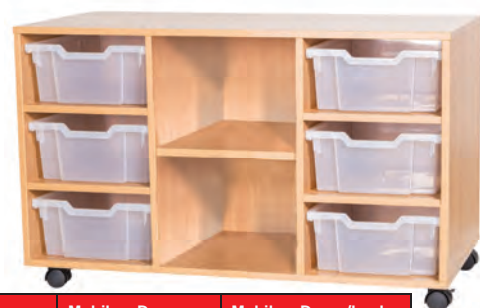

Mobile Unit		Mobile + Doors		Mobile + Doors/Locks	
A13106		A13107		A13108	
Static Unit		Static + Doors		Static + Doors/Locks	
A13109		A13110		A13111	



6 High 9 Deep Tray Triple Tray Unit

H615mm x W1024mm x D460mm



Mobile Unit		Mobile + Doors		Mobile + Doors/Locks	
A13079		A13080		A13081	
Static Unit		Static + Doors		Static + Doors/Locks	
A13082		A13083		A13084	

6 High 6 Extra Deep Tray Triple

H615mm x W1024mm x D460mm



Mobile Unit		Mobile + Doors		Mobile + Doors/Locks	
A13062		A13085		A13086	
Static Unit		Static + Doors		Static + Doors/Locks	
A13087		A13088		A13089	



6 High Open Shelf Triple Unit

H615mm x W1024mm x D460mm



Mobile Unit		Static Unit	
A23023		A23024	

6 High Combination Tray Triple

H615mm x W1024mm x D460mm



6 Shallow Trays
3 x Deep Trays
2 x Extra Deep Trays

Mobile Unit		Mobile + Doors		Mobile + Doors/Locks	
A13090		A13091		A13092	
Static Unit		Static + Doors		Static + Doors/Locks	
A13093		A13094		A13095	



6 High Triple Cupboard

H615mm x W1024mm x D480mm



Mobile + Doors		Mobile + Doors/Locks	
A23025		A23027	
Static + Doors		Static + Doors/Locks	
A23026		A23028	

PREMIUM TRAY STORAGE

6 High 24 Tray Quad Unit

H615mm x W1358mm x D460mm



Mobile Unit	Mobile + Doors	Mobile + Doors/Locks
A14007	A14008	A14009
Static Unit	Static + Doors	Static + Doors/Locks
A14010	A14011	A14012

6 High 12 Tray Quad with Middle Shelf

H615mm x W1358mm x D460mm



Mobile Unit	Mobile + Doors	Mobile + Doors/Locks
A14075	A14076	A14077
Static Unit	Static + Doors	Static + Doors/Locks
A14078	A14079	A14080



6 High 12 Deep Tray Quad Unit

H615mm x W1358mm x D460mm



Mobile Unit	Mobile + Doors	Mobile + Doors/Locks
A14127	A14128	A14129
Static Unit	Static + Doors	Static + Doors/Locks
A14130	A14131	A14132



6 High 12 Tray Quad with Shelf

H615mm x W1358mm x D460mm



Mobile Unit	Mobile + Door	Mobile + Door/Lock
A14069	A14070	A14071
Static Unit	Static + Door	Static + Door/Lock
A14072	A14073	A14074



6 High 12 Shallow, 6 Deep Tray Quad

H615mm x W1358mm x D460mm



Mobile Unit	Mobile + Doors	Mobile + Doors/Locks
A14087	A14088	A14089
Static Unit	Static + Doors	Static + Doors/Locks
A14090	A14091	A14092



6 High 12 Deep Tray Quad

H615mm x W1358mm x D460mm

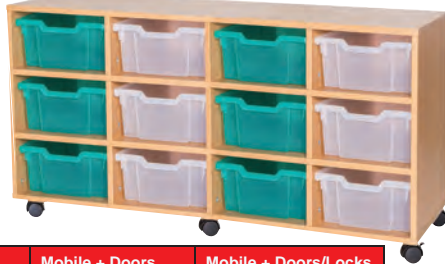

Mobile Unit	Mobile + Doors	Mobile + Doors/Locks
A14081	A14082	A14083
Static Unit	Static + Doors	Static + Doors/Locks
A14084	A14085	A14086



6 High 6 Deep + 4 Extra Deep Tray Quad

H615mm x W1358mm x D460mm

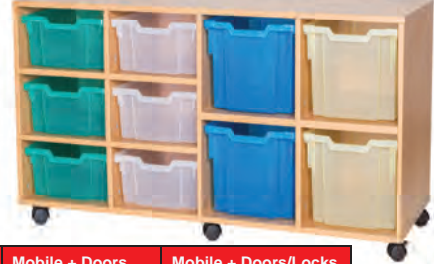

Mobile Unit	Mobile + Doors	Mobile + Doors/Locks
A14437	A14438	A14099
Static Unit	Static + Doors	Static + Doors/Locks
A14100	A14101	A14102



6 High 8 Extra Deep Tray Quad

H615mm x W1358mm x D460mm



Mobile Unit	Mobile + Doors	Mobile + Doors/Locks
A14103	A14104	A14105
Static Unit	Static + Doors	Static + Doors/Locks
A14106	A14107	A14108



6 High 12 Tray Quad Cupboards with Shelf

H615mm x W1358mm x D480mm



Mobile + Doors	Mobile + Doors/Locks
A14439	A14440
Static + Doors	Static + Doors/Locks
A14441	A14442



6 High 8 Extra Deep Tray Quad

H615mm x W1358mm x D460mm



Mobile Unit	Mobile + Doors	Mobile + Doors/Locks
A14066	A14116	A14117
Static Unit	Static + Doors	Static + Doors/Locks
A14067	A14119	A14120



6 High 6 Deep Tray Quad with Shelf

H615mm x W1358mm x D460mm



Mobile Unit	Mobile + Doors	Mobile + Doors/Locks
A14121	A14122	A14123
Static Unit	Static + Doors	Static + Doors/Locks
A14124	A14125	A14126



6 High 12 Shallow, 4 Extra Deep Tray Quad

H615mm x W1358mm x D460mm



Mobile Unit	Mobile + Doors	Mobile + Doors/Locks
A14093	A14094	A14095
Static Unit	Static + Doors	Static + Doors/Locks
A14096	A14097	A14098



6 High Open Shelf Quad Unit

H615mm x W1358mm x D460mm



Mobile Unit	Static Unit
A14109	A14112

7 High 14 Tray Double Unit

H697mm x W690mm x D460mm



Mobile Unit		Mobile + Doors		Mobile + Doors/Locks	
A12013		A12014		A12015	
Static Unit		Static + Doors		Static + Doors/Locks	
A12016		A12017		A12018	

7 High 7 Tray Single Unit

H697mm x W356mm x D460mm



Mobile Unit		Mobile + Doors		Mobile+Drs/Locks	
A11013		A11014		A11015	
Static Unit		Static + Doors		Static+Drs/Locks	
A11016		A11017		A11018	

7 High Open Shelf Single

H697mm x W356mm x D460mm



Mobile Unit		Static Unit	
A21007		A21008	

7 High Open Shelf Double

H697mm x W690mm x D460mm



Mobile Unit		Static Unit	
A22007		A22008	

7 High Single Cupboard

H697mm x W356mm x D480mm



Mobile + Doors		Mobile + Doors/Locks	
A21009		A21011	
Static + Doors		Static + Doors/Locks	
A21010		A21012	

7 High Double Cupboard

H697mm x W690mm x D480mm



Mobile + Doors		Mobile + Doors/Locks	
A22009		A22010	
Static + Doors		Static + Doors/Locks	
A22011		A22012	

7 High 7 Tray Double with Shelf

H697mm x W690mm x D460mm



Mobile Unit		Mobile + Doors		Mobile+Drs/Locks	
A12111		A12112		A12113	
Static Unit		Static + Doors		Static+Drs/Locks	
A12114		A12115		A12116	

7 High 21 Tray Triple Tray Unit

H697mm x W1024mm x D460mm



Mobile Unit	Mobile + Doors	Mobile + Doors/Locks
A13013	A13014	A13015
Static Unit	Static + Doors	Static + Doors/Locks
A13016	A13017	A13018

7 High 14 Tray Triple with Centre Shelf

H697mm x W1024mm x D460mm



Mobile Unit	Mobile + Doors	Mobile + Doors/Locks
A13294	A13295	A13296
Static Unit	Static + Doors	Static + Doors/Locks
A13297	A13298	A13299

7 High Combination Double

H697mm x W690mm x D460mm



Mobile Unit	Mobile + Doors	Mobile + Drs/Locks
A12340	A12341	A12342
Static Unit	Static + Doors	Static + Drs/Locks
A12343	A12117	A12118

7 x Shallow, 1 x Extra Deep & 1 x Jumbo trays

7 High 7 Tray Triple with Shelf

H697mm x W1024mm x D460mm



Mobile Unit	Mobile + Doors	Mobile + Doors/Locks
A13118	A13119	A13120
Static Unit	Static + Doors	Static + Doors/Locks
A13121	A13122	A13123

Optional door covers trays only

7 High 7 Tray Triple with Cupboards

H697mm x W1024mm x D480mm



Mobile + Doors	Mobile + Doors/Locks
A13124	A13125
Static + Doors	Static + Doors/Locks
A13126	A13127

7 High Open Shelf Triple Unit

H697mm x W1024mm x D460mm



Mobile Unit		Static Unit	
A23029		A23030	

7 High Triple Cupboard

H697mm x W1024mm x D480mm



Mobile + Doors		Mobile + Doors/Locks	
A23031		A23032	
Static + Doors		Static + Doors/Locks	
A23033		A23034	

All Gratnells Tray are included in the price

Choice of Gratnells Tray Colours



- Red
- Yellow
- Blue
- Green
- Cyan
- Pink
- Orange
- Lime
- Blueberry Jelly
- Strawberry Jelly
- Kiwi Jelly
- Purple
- Grape Jelly
- Lemon Jelly
- Light Grey
- Clear



7 High 14 Tray Cupboards + Shelf Quad

H697mm x W1358mm x D480mm



Mobile + Doors		Mobile + Doors/Locks	
A14448		A14449	
Static + Doors		Static + Doors/Locks	
A14450		A14451	



7 High Open Shelf Quad Unit

H697mm x W1358mm x D460mm



Mobile Unit		Static Unit	
A14157		A14160	

7 High 28 Tray Quad Unit

H697mm x W1358mm x D460mm



Mobile Unit	Mobile + Doors	Mobile+Doors/Locks
A14013	A14014	A14015
Static Unit	Static + Doors	Static+Doors/Locks
A14016	A14017	A14018

7 High 14 Tray Quad with Middle Shelf

H697mm x W1358mm x D460mm



Mobile Unit	Mobile + Doors	Mobile+Doors/Locks
A14151	A14152	A14153
Static Unit	Static + Doors	Static+Doors/Locks
A14154	A14155	A14156



7 High 18 Tray Combination Quad

H697mm x W1358m x D460mm

14 x Shallow,
2 x Extra Deep
& 2 Jumbo
trays



Mobile Unit	Mobile + Doors	Mobile+Doors/Locks
A14145	A14146	A14147
Static Unit	Static + Doors	Static+Doors/Locks
A14148	A14149	A14150



7 High 14 Tray Quad with Shelf

H697mm x W1358m x D460mm



Mobile Unit	Mobile + Doors	Mobile+Doors/Locks
A14139	A14140	A14141
Static Unit	Static + Doors	Static+Doors/Locks
A14142	A14143	A14144



Save money by ordering empty units & using your existing trays!



See how much you can save - remember to look for the logo!

7 High 3 Tray Single Unit

H697mm x W356mm x D460mm



1 x Shallow, 1 x Deep, 1 x Jumbo trays.

Mobile Unit	Mobile + Doors	Mobile+Drs/Locks
A11067	A11068	A11069
Static Unit	Static + Doors	Static+Drs/Locks
A11070	A11071	A11072

7 High Combination Tray Triple

H697mm x W1024mm x D460mm



3 x Shallow, 3 x Deep, 3 x Jumbo trays.

Mobile Unit	Mobile + Doors	Mobile + Doors/Locks
A13112	A13113	A13114
Static Unit	Static + Doors	Static + Doors/Locks
A13115	A13116	A13117



7 High Combi. Tray Double

H697mm x W690mm x D460mm



2 x Shallow, 2 x Deep, 2 x Jumbo trays.

Mobile Unit	Mobile + Doors	Mobile+Drs/Locks
A12119	A12120	A12121
Static Unit	Static + Doors	Static+Drs/Locks
A12122	A12123	A12124

7 High 12 Tray Combination Quad

H697mm x W1358mm x D460mm



4 x Shallow, 4 x Deep & 4 x Jumbo trays

Mobile Unit	Mobile + Doors	Mobile+Doors/Locks
A14133	A14134	A14135
Static Unit	Static + Doors	Static+Doors/Locks
A14136	A14137	A14138



8 High Single Tray Unit

H779mm x W356mm x D460mm



Mobile Unit	Mobile + Doors	Mobile+Drs/Locks
A11019	A11020	A11021
Static Unit	Static + Doors	Static+Drs/Locks
A11022	A11023	A11024

8 High 24 Tray Triple Unit

H779mm x W1024mm x D460mm



Mobile Unit	Mobile + Doors	Mobile+Drs/Locks
A13019	A13020	A13021
Static Unit	Static + Doors	Static+Drs/Locks
A13022	A13023	A13024

16 Tray Double

H779mm x W690mm x D460mm



Mobile Unit	Mobile + Doors	Mobile+Drs/Locks
A12019	A12020	A12021
Static Unit	Static + Doors	Static+Drs/Locks
A12022	A12023	A12024

8 High 32 Tray Quad Unit

H779mm x W1358mm x D460mm



Mobile Unit	Mobile + Doors	Mobile+Drs/Locks
A14019	A14020	A14021
Static Unit	Static + Doors	Static+Drs/Locks
A14022	A14023	A14024

PREMIUM TRAY STORAGE

8 High 4 Deep Tray Single

H779mm x W356mm x D460mm



Mobile Unit	Mobile + Door	Mobile+Door/Lock
A11073	A11074	A11075
Static Unit	Static + Door	Static+Door/Lock
A11076	A11077	A11078

8 High 8 Deep Tray Double

H779mm x W690mm x D460mm



Mobile Unit	Mobile + Doors	Mobile+Drs/Locks
A12137	A12138	A12139
Static Unit	Static + Doors	Static+Drs/Locks
A12140	A12141	A12142

8 High 12 Deep Tray Triple

H779mm x W1024mm x D460mm



Mobile Unit	Mobile + Doors	Mobile+Drs/Locks
A13134	A13135	A13136
Static Unit	Static + Doors	Static+Drs/Locks
A13137	A13138	A13139

8 High Open Shelf Single

H779mm x W356mm x D460mm



Mobile Unit	Static Unit
A21019	A21020

8 High Open Shelf Double

H779mm x W690mm x D460mm



Mobile Unit	Static Unit
A22019	A22020

8 High Combination Double

H779mm x W690mm x D460mm



8 x Shallow & 4 x Deep trays

Mobile Unit	Mobile + Doors	Mobile+Drs/Locks
A12143	A12144	A12145
Static Unit	Static + Doors	Static+Drs/Locks
A12146	A12147	A12148

8 High Single Cupboard

H779mm x W356mm x D480mm



Mobile + Door	Mobile + Door/Lock
A21021	A21023
Static + Door	Static + Door/Lock
A21022	A21024

8 High Double Cupboard

H779mm x W690mm x D480mm



Mobile + Doors	Mobile + Doors/Locks
A22021	A22023
Static + Doors	Static + Doors/Locks
A22022	A22024

8 High 8 Tray Double + Shelves

H779mm x W690mm x D480mm



Mobile Unit	Mobile + Doors	Mobile+Drs/Locks
A12131	A12132	A12133
Static Unit	Static + Doors	Static+Drs/Locks
A12134	A12135	A12136

8 High 2 Jumbo Tray Single

H779mm x W356mm x D460mm



Mobile Unit	Mobile + Door	Mobile+Door/Lock
A11139	A11140	A11141
Static Unit	Static + Door	Static+Door/Lock
A11142	A11143	A11144

8 High 4 Jumbo Tray Double

H779mm x W690mm x D460mm



Mobile Unit	Mobile + Doors	Mobile+Drs/Locks
A12149	A12150	A12151
Static Unit	Static + Doors	Static+Drs/Locks
A12152	A12153	A12154

8 High 6 Jumbo Tray Triple Unit

H779mm x W1024mm x D460mm



Mobile Unit	Mobile + Doors	Mobile+Drs/Locks
A13146	A13147	A13148
Static Unit	Static + Doors	Static+Drs/Locks
A13149	A13150	A13151



8 High 8 Tray Triple with Shelves

H779mm x W1024mm x D460mm



Optional door covers trays only

Mobile Unit	Mobile + Doors	Mobile+Drs/Locks
A13140	A13141	A13142
Static Unit	Static + Doors	Static+Drs/Locks
A13143	A13144	A13145

Save money by ordering empty units & using your existing trays!



See how much you can save - remember to look for the logo!

8 High Open Shelf Triple Unit

H779mm x W1024mm x D460mm



Mobile Unit	Static Unit
A23041	A23044

8 High Triple Cupboard

H779mm x W1024mm x D480mm



Mobile + Doors	Mobile + Doors/Locks
A23042	A23043
Static + Doors	Static + Doors/Locks
A23045	A23046

8 High 16 Tray Triple with Shelves

H779mm x W1024mm x D460mm



Mobile Unit		Mobile + Doors		Mobile+Drs/Locks	
A13162		A13163		A13164	
Static Unit		Static + Doors		Static+Drs/Locks	
A13165		A13166		A13167	

8 High 8 Deep Tray Triple with Shelves

H779mm x W1024mm x D460mm



Mobile Unit		Mobile + Doors		Mobile+Drs/Locks	
A13168		A13169		A13170	
Static Unit		Static + Doors		Static+Drs/Locks	
A13171		A13172		A13173	

8 High 8 Tray Triple with Cupboards

H779mm x W1024mm x D460mm



Mobile + Doors		Mobile + Doors/Locks	
A13152		A13153	
Static + Doors		Static + Doors/Locks	
A13154		A13155	

8 High 14 Tray Combination Triple

H779mm x W1024mm x D460mm



Mobile Unit		Mobile + Doors		Mobile+Drs/Locks	
A13156		A13157		A13158	
Static Unit		Static + Doors		Static+Drs/Locks	
A13159		A13160		A13161	

8 x Shallow, 4 x Deep & 2 x Jumbo trays

8 High 16 Tray Quad with Shelves

H779mm x W1358mm x D460mm



Mobile Unit		Mobile + Doors		Mobile+Drs/Locks	
A14217		A14218		A14219	
Static Unit		Static + Doors		Static+Drs/Locks	
A14220		A14221		A14222	

8 High 8 Deep Tray Quad with Shelves

H779mm x W1358mm x D460mm



Mobile Unit		Mobile + Doors		Mobile+Drs/Locks	
A14065		A14224		A14225	
Static Unit		Static + Doors		Static+Drs/Locks	
A14226		A14227		A14228	

8 High 16 Tray Quad with Shelves

H779mm x W1358mm x D460mm



Mobile Unit		Mobile + Doors		Mobile+Drs/Locks	
A14211		A14212		A14213	
Static Unit		Static + Doors		Static+Drs/Locks	
A14214		A14215		A14216	

8 High 16 Tray Quad with Cupboards

H779mm x W1358mm x D480mm



Mobile + Doors		Mobile + Doors/Locks	
A14452		A14453	
Static + Doors		Static + Doors/Locks	
A14454		A14455	

8 High 8 Deep Tray Double

H779mm x W690mm x D460mm



Mobile Unit	Mobile + Doors	Mobile+Drs/Locks
A12161	A12162	A12163
Static Unit	Static + Doors	Static+Drs/Locks
A12164	A12165	A12166

8 High 16 Deep Tray Quad

H779mm x W1358mm x D460mm



Mobile Unit	Mobile + Doors	Mobile+Drs/Locks
A14187	A14188	A14189
Static Unit	Static + Doors	Static+Drs/Locks
A14190	A14191	A14192

8 High 4 Jumbo Tray Double

H779mm x W690mm x D460mm



Mobile Unit	Mobile + Doors	Mobile+Drs/Locks
A12155	A12156	A12157
Static Unit	Static + Doors	Static+Drs/Locks
A12158	A12159	A12160

8 High 16 Deep Tray Quad

H779mm x W1358mm x D460mm



Mobile Unit	Mobile + Doors	Mobile+Drs/Locks
A14181	A14182	A14183
Static Unit	Static + Doors	Static+Drs/Locks
A14184	A14185	A14186

8 High 8 Jumbo Tray Quad Unit

H779mm x W1358mm x D460mm



Mobile Unit	Mobile + Doors	Mobile+Drs/Locks
A14199	A14200	A14201
Static Unit	Static + Doors	Static+Drs/Locks
A14202	A14203	A14204



8 High 8 Jumbo Tray Quad Unit

H779mm x W1358mm x D460mm



Mobile Unit	Mobile + Doors	Mobile+Drs/Locks
A14205	A14206	A14207
Static Unit	Static + Doors	Static+Drs/Locks
A14208	A14209	A14210



8 High 4 Jumbo, 8 Deep Tray Quad

H779mm x W1358mm x D460mm



Mobile Unit	Mobile + Doors	Mobile+Drs/Locks
A14193	A14194	A14195
Static Unit	Static + Doors	Static+Drs/Locks
A14196	A14197	A14198



8 High Open Shelf Quad Unit

H779mm x W1358mm x D460mm



Mobile Unit	Static Unit
A24001	A24004

PREMIUM TRAY STORAGE

9 High 18 Tray Double Unit

H861mm x W690mm x D460mm



Mobile Unit	Mobile + Doors	Mobile + Doors/Locks
A12025	A12026	A12027
Static Unit	Static + Doors	Static + Doors/Locks
A12028	A12029	A12030

9 High 9 Tray Single Unit

H861mm x W356mm x D460mm



Mobile Unit	Mobile + Doors	Mobile+Drs/Lock
A11025	A11026	A11027
Static Unit	Static + Doors	Static+Drs/Lock
A11028	A11029	A11030

9 High Open Shelf Single

H861mm x W356mm x D460mm



Mobile Unit	Static Unit
A21025	A21028

9 High Single Cupboard

H861mm x W356mm x D480mm



Mobile Cupboard	Mobile Cupboard + Lock
A21026	A21027
Static Cupboard	Static Cupboard + Lock
A21029	A21030

9 High 3 Combination Tray

H861mm x W356mm x D460mm



1 x Deep, Extra Deep & Jumbo trays

Mobile Unit	Mobile + Doors	Mobile+Drs/Locks
A11085	A11086	A11087
Static Unit	Static + Doors	Static+Drs/Locks
A11088	A11089	A11090

9 High 6 Combination Tray

H861mm x W690mm x D480mm



2 x Deep, Extra Deep & Jumbo trays

Mobile Unit	Mobile + Doors	Mobile+Drs/Locks
A12173	A12174	A12175
Static Unit	Static + Doors	Static+Drs/Locks
A12176	A12177	A12178

9 High 6 Extra Deep Double

H861mm x W690mm x D460mm



Mobile Unit	Mobile + Doors	Mobile+Drs/Locks
A12203	A12204	A12205
Static Unit	Static + Doors	Static+Drs/Locks
A12206	A12207	A12208

9 High Open Shelf Double
H861mm x W690mm x D460mm



Mobile Unit		Static Unit	
A22025		A22028	

9 High Double Cupboard
H861mm x W690mm x D480mm



Mobile + Doors		Mobile + Doors/Locks	
A22026		A22027	
Static + Doors		Static + Doors/Locks	
A22029		A22030	

9 High 9 Tray Double
H861mm x W690mm x D460mm



Mobile Unit		Mobile + Doors		Mobile+Drs/Locks	
A12197		A12198		A12199	
Static Unit		Static + Doors		Static+Drs/Locks	
A12200		A12201		A12202	

9 High Triple Cupboard
H861mm x W1024mm x D480mm



Mobile Cupboard	
A23048	
Mobile Cup + Locks	
A23049	
Static Cupboard	
A23051	
Static + Doors/Locks	
A23052	

4 Deep & 3 Extra Deep Tray Double

H861mm x W690mm x D460mm



Mobile Unit	
A12185	
Mobile + Doors	
A12186	
Mobile + Drs/Locks	
A12187	
Static Unit	
A12188	
Static + Doors	
A12189	
Static + Doors/Locks	
A12190	



9 High Open Shelf Triple Unit
H861mm x W1024mm x D460mm



Mobile Unit	
A23047	
Static Unit	
A23050	

9 Shallow & 3 Extra Deep Tray Double

H861mm x W690mm x D460mm



Mobile Unit		Mobile + Doors		Mobile+Drs/Lock	
A12179		A12180		A12181	
Static Unit		Static + Doors		Static+Drs/Lock	
A12182		A12183		A12184	



9 High 9 Tray Triple with Shelves
H861mm x W1024mm x D460mm



Mobile Unit	
A13174	
Mobile + Door	
A13175	
Mobile + Door/Lock	
A13176	
Static Unit	
A13177	
Static + Door	
A13178	
Static + Door/Lock	
A13179	



Optional door covers trays only

PREMIUM TRAY STORAGE

9 High 27 Tray Triple Unit

H861mm x W1024mm x D460mm

Choice of Grannells Tray Colours



- Red
- Yellow
- Blue
- Green
- Cyan
- Pink
- Orange
- Lime
- Blueberry Jelly
- Strawberry Jelly
- Kiwi Jelly
- Purple
- Grape Jelly
- Lemon Jelly
- Light Grey
- Clear



Mobile Unit	Mobile + Doors	Mobile + Doors/Locks
A13025	A13026	A13027
Static Unit	Static + Doors	Static + Doors/Locks
A13028	A13029	A13030

9 High Combination Tray Triple

H861mm x W1024mm x D460mm



3 x Deep, 3 x Extra Deep & 3 x Jumbo trays

Mobile Unit	Mobile + Doors	Mobile + Doors/Locks
A13192	A13193	A13194
Static Unit	Static + Doors	Static + Doors/Locks
A13195	A13196	A13197



9 High Combination Tray Triple

H861mm x W1024mm x D460mm



9 x Shallow, 4 x Deep & 3 x Extra Deep trays

Mobile Unit	Mobile + Doors	Mobile + Doors/Locks
A13180	A13181	A13182
Static Unit	Static + Doors	Static + Doors/Locks
A13183	A13184	A13185



9 High 18 Tray Triple with Shelves

H861mm x W1024mm x D460mm



Mobile Unit	Mobile + Doors	Mobile + Doors/Locks
A13202	A13203	A13204
Static Unit	Static + Doors	Static + Doors/Locks
A13205	A13206	A13207



9 High 9 Tray Triple with Cupboards

H861mm x W1024mm x D480mm



Mobile + Doors	Mobile + Doors/Locks
A13198	A13199
Static + Doors	Static + Doors/Locks
A13200	A13201



9 High 36 Tray Quad Unit

H861mm x W1358mm x D460mm



Mobile Unit		Mobile + Doors		Mobile + Doors/Locks	
A14025		A14026		A14027	
Static Unit		Static + Doors		Static + Doors/Locks	
A14028		A14029		A14030	

9 High 18 Tray Quad with Shelves

H861mm x W1358mm x D460mm



Mobile Unit		Mobile + Doors		Mobile + Doors/Locks	
A14259		A14260		A14261	
Static Unit		Static + Doors		Static + Doors/Locks	
A14262		A14263		A14264	



9 High 18 Tray Quad with Shelves

H861mm x W1358mm x D460mm



Mobile Unit		Mobile + Doors		Mobile + Doors/Locks	
A14275		A14276		A14277	
Static Unit		Static + Doors		Static + Doors/Locks	
A14278		A14279		A14280	



9 High 12 Extra Deep Tray Quad

H861mm x W1358mm x D460mm



Mobile Unit		Mobile + Doors		Mobile + Doors/Locks	
A14058		A14270		A14271	
Static Unit		Static + Doors		Static + Doors/Locks	
A14272		A14273		A14274	

9 High 12 Combination Tray Quad Unit

H861mm x W1358mm x D460mm



Mobile Unit	Mobile + Doors	Mobile + Doors/Locks
A14235	A14236	A14237
Static Unit	Static + Doors	Static + Doors/Locks
A14238	A14239	A14240

4 x Deep, 4 x Extra Deep & 4 x Jumbo trays

9 High 8 Deep & 6 Extra Deep Tray Quad

H861mm x W1358mm x D460mm



Mobile Unit	Mobile + Doors	Mobile + Doors/Locks
A14063	A14064	A14243
Static Unit	Static + Doors	Static + Doors/Locks
A14244	A14245	A14246



9 High 18 Tray Quad with Cupboards

H861mm x W1358mm x D480mm



Mobile + Doors	Mobile + Doors/Locks
A14265	A14266
Static + Doors	Static + Doors/Locks
A14267	A14268



9 High 6 Extra Deep Tray Quad with Shelves

H861mm x W1358mm x D460mm



Mobile Unit	Mobile + Doors	Mobile + Doors/Lock
A14281	A14282	A14283
Static Unit	Static + Doors	Static + Doors/Lock
A14284	A14285	A14286



9 High 25 Combination Tray Quad Unit

H861mm x W1358mm x D460mm



4 x Deep, 18 x Shallow & 3 x Extra Deep trays

Mobile Unit	Mobile + Doors	Mobile + Doors/Locks
A14287	A14288	A14289
Static Unit	Static + Doors	Static + Doors/Locks
A14290	A14291	A14292



9 High 18 Shallow, 6 Extra Deep Tray Quad Unit

H861mm x W1358mm x D460mm



Mobile Unit	Mobile + Doors	Mobile + Doors/Locks
A14253	A14254	A14255
Static Unit	Static + Doors	Static + Doors/Locks
A14256	A14257	A14258

18 x Shallow & 6 x Extra Deep trays

9 High 6 Extra Deep & 18 Shallow Tray Quad

H861mm x W1358mm x D460mm



18 x Shallow & 6 x Extra Deep trays

Mobile Unit	Mobile + Doors	Mobile + Doors/Locks
A14247	A14248	A14249
Static Unit	Static + Doors	Static + Doors/Locks
A14250	A14251	A14252



All Gratnells trays are included in the price

Choice of Gratnells Tray Colours



9 High Open Shelf Quad Unit

H861mm x W1358mm x D460mm



Mobile Unit	Static Unit
A14293	A14296



9 High 3 Extra Deep Single

H861mm x W356mm x D460mm



Mobile Unit	Mobile + Door	Mobile+Door/Lock
A11079	A11080	A11081
Static Unit	Static + Door	Static+Door/Lock
A11082	A11083	A11084

9 High 9 Extra Deep Tray Triple

H861mm x W1024mm x D460mm



Mobile Unit	Mobile + Door	Mobile+Door/Lock
A13063	A13187	A13188
Static Unit	Static + Door	Static+Door/Lock
A13189	A13190	A13191

9 High 6 Extra Deep Double

H861mm x W690mm x D460mm



Mobile Unit	Mobile + Doors	Mobile+Drs/Locks
A12059	A12168	A12169
Static Unit	Static + Doors	Static+Drs/Locks
A12170	A12171	A12172

9 High 12 Extra Deep Tray Quad

H861mm x W1358mm x D480mm



Mobile Unit	Mobile + Doors	Mobile + Doors/Locks
A14229	A14062	A14231
Static Unit	Static + Doors	Static + Doors/Locks
A14232	A14233	A14234

10 High 4 Combination Tray

H943mm x W356mm x D460mm



1 x Shallow, Deep, Extra Deep & Jumbo trays

Mobile Unit	Mobile + Doors	Mobile+Drs/Locks
A11097	A11098	A11099
Static Unit	Static + Doors	Static+Drs/Locks
A11100	A11101	A11102

10 High 12 Combination Tray Triple

H943mm x W1024mm x D460mm



3 x Shallow, Deep, Extra Deep & Jumbo trays

Mobile Unit	Mobile + Doors	Mobile + Doors/Locks
A13057	A13208	A13209
Static Unit	Static + Doors	Static + Doors/Locks
A13210	A13211	A13212



10 High 8 Combination Tray

H943mm x W690mm x D460mm



2 x Shallow, Deep, Extra Deep & Jumbo trays

Mobile Unit	Mobile + Doors	Mobile+Drs/Locks
A12215	A12216	A12217
Static Unit	Static + Doors	Static+Drs/Locks
A12218	A12219	A12220

10 High 16 Combination Tray Quad

H943mm x W1358mm x D460mm



4 x Shallow, Deep, Extra Deep & Jumbo trays

Mobile Unit	Mobile + Doors	Mobile+Drs/Locks
A14057	A14311	A14312
Static Unit	Static + Doors	Static+Doors/Locks
A14313	A14314	A14315



10 High 20 Tray Double Unit

H943mm x W690mm x D460mm



Mobile Unit	Mobile + Doors	Mobile + Doors/Locks
A12031	A12032	A12033
Static Unit	Static + Doors	Static + Doors/Locks
A12034	A12035	A12036



10 High Open Shelf Double

H943mm x W690mm x D460mm



Mobile Unit	Static Unit
A22031	A22032

10 High Double Cupboard

H943mm x W690mm x D480mm



Mobile + Doors	Mobile + Doors/Locks
A22033	A22035
Static + Doors	Static + Doors/Locks
A22034	A22036

10 High 10 Tray Single Unit

H943mm x W356mm x D460mm



Mobile Unit	Mobile + Doors	Mobile+Drs/Lock
A11031	A11032	A11033
Static Unit	Static + Doors	Static+Drs/Lock
A11034	A11035	A11036

10 High Single Cupboard

H943mm x W356mm x D480mm



Mobile + Doors	Mobile + Doors/Locks
A21033	A21035
Static + Doors	Static + Doors/Locks
A21034	A21036

10 High Open Shelf Single

H943mm x W356mm x D460mm



Mobile Unit	Static Unit
A21031	A21032

10 High 10 Tray Dble + Shelves

H943mm x W690mm x D460mm



Mobile Unit	Mobile + Doors	Mobile+Drs/Locks
A12221	A12222	A12223
Static Unit	Static + Doors	Static+Drs/Locks
A12224	A12225	A12226

Choice of Gratnells Tray Colours



- Red
- Yellow
- Blue
- Green
- Cyan
- Pink
- Orange
- Lime
- Blueberry Jelly
- Strawberry J
- Kiwi Jelly
- Purple
- Grape Jelly
- Lemon Jelly
- Light Grey
- Clear

10 High 30 Tray Triple Unit

H943mm x W1024mm x D460mm



10 High 10 Tray Triple with Shelves

H943mm x W1024mm x D460mm



Optional door covers trays only



Mobile Unit	Mobile + Door	Mobile + Door/Lock
A13219	A13220	A13221
Static Unit	Static + Door	Static + Door/Lock
A13222	A13223	A13224

Mobile Unit	Mobile + Doors	Mobile + Doors/Locks
A13031	A13032	A13033
Static Unit	Static + Doors	Static + Doors/Locks
A13034	A13035	A13036

10 High 20 Tray Triple with Shelves

H943mm x W1024mm x D460mm



Mobile Unit	Mobile + Doors	Mobile + Doors/Locks
A13225	A13226	A13227
Static Unit	Static + Doors	Static + Doors/Locks
A13228	A13229	A13230

10 High 10 Tray Triple with Cupboards

H943mm x W1024mm x D480mm



Mobile + Doors	Mobile + Doors/Locks
A13289	A13290
Static + Doors	Static + Doors/Locks
A13292	A13293

PREMIUM STORAGE

10 High 40 Tray Quad Unit

H943mm x W1358mm x D460mm



Mobile Unit	Mobile + Doors	Mobile+Drs/Locks
A14031	A14032	A14033
Static Unit	Static + Doors	Static+Doors/Locks
A14034	A14035	A14036



10 High 20 Tray Quad with Shelves

H943mm x W1358mm x D460mm



Mobile Unit	Mobile + Doors	Mobile+Drs/Locks
A14328	A14329	A14330
Static Unit	Static + Doors	Static+Drs/Locks
A14331	A14332	A14333



10 High 20 Tray Quad with Shelves

H943mm x W1358mm x D460mm



Mobile Unit	Mobile + Doors	Mobile+Drs/Locks
A14316	A14317	A14318
Static Unit	Static + Doors	Static+Drs/Locks
A14319	A14320	A14321



10 High Open Shelf Triple Unit

H943mm x W1024mm x D460mm



Mobile Unit		Static Unit	
A23053		A23054	

10 High Cupboard Unit

H943mm x W1024mm x D480mm



Mobile + Doors		Mobile + Doors/Locks	
A23055		A23056	
Static + Doors		Static + Doors/Locks	
A23057		A23058	

10 High 20 Tray Quad with Cupboards

H943mm x W1358mm x D480mm



Mobile + Doors		Mobile + Doors/Locks	
A14334		A14335	
Static + Doors		Static + Doors/Locks	
A14336		A14337	

10 High Open Shelf Quad Unit

H943mm x W1358mm x D460mm



Mobile Unit		Static Unit	
A24007		A24008	

11 High 10 Deep Tray Triple + Shelves

H1025mm x W1024mm x D460mm

Choice of Gragnells Tray Colours



Mobile Unit	Mobile + Doors	Mobile + Doors/Locks
A13231	A13232	A13233
Static Unit	Static + Doors	Static + Doors/Locks
A13234	A13235	A13236

11 High 5 Deep Tray Single Unit

H1025mm x W356mm x D460mm



Mobile Unit	Mobile + Door	Mobile + Door/Lock
A11091	A11092	A11093
Static Unit	Static + Door	Static + Door/Lock
A11094	A11095	A11096



11 High 10 Deep Tray Double Unit

H1025mm x W690mm x D460mm



Mobile Unit	Mobile + Doors	Mobile + Doors/Locks
A12227	A12228	A12229
Static Unit	Static + Doors	Static + Doors/Locks
A12230	A12231	A12232



11 High 16 Combination Tray Double

H1025mm x W690mm x D460mm



11 x Shallow trays & 5 x Deep trays

Mobile Unit	Mobile + Doors	Mobile + Doors/Locks
A12209	A12210	A12211
Static Unit	Static + Doors	Static + Doors/Locks
A12212	A12213	A12214



11 High 10 Deep Tray Double

H1025mm x W690mm x D460mm



Mobile Unit	Mobile + Doors	Mobile + Doors/Locks
A12233	A12234	A12235
Static Unit	Static + Doors	Static + Doors/Locks
A12236	A12237	A12238



11 High 10 Deep Tray Quad + Shelves

H1025mm x W1358mm x D460mm



Mobile Unit	Mobile + Doors	Mobile + Doors/Locks
A14338	A14339	A14340
Static Unit	Static + Doors	Static + Doors/Locks
A14341	A14342	A14343



11 High 10 Deep Tray Quad + Shelves

H1025mm x W1358mm x D460mm



Mobile Unit	Mobile + Doors	Mobile + Doors/Locks
A14322	A14323	A14324
Static Unit	Static + Doors	Static + Doors/Locks
A14325	A14326	A14327



11 High 15 Deep Tray Triple Unit

H1025mm x W1024mm x D460mm



Mobile Unit	Mobile + Doors	Mobile + Doors/Locks
A13213	A13214	A13215
Static Unit	Static + Doors	Static + Doors/Locks
A13216	A13217	A13218



11 High 20 Deep Tray Quad Unit

H1025mm x W1358mm x D460mm



Mobile Unit	Mobile + Doors	Mobile + Doors/Locks
A14299	A14300	A14301
Static Unit	Static + Doors	Static + Doors/Locks
A14302	A14303	A14304



11 High 22 Shallow, 10 Deep Tray Quad

H1025mm x W1358mm x D460mm



Mobile Unit	Mobile + Doors	Mobile + Doors/Locks
A14344	A14345	A14346
Static Unit	Static + Doors	Static + Doors/Locks
A14347	A14348	A14349



11 High 20 Deep Tray Quad Unit

H1025mm x W1358mm x D460mm



Mobile Unit	Mobile + Doors	Mobile + Doors/Locks
A14305	A14306	A14307
Static Unit	Static + Doors	Static + Doors/Locks
A14308	A14309	A14310



PREMIUM TRAY STORAGE

12 High 24 Tray Double Unit

H1107mm x W690mm x D460mm



Mobile Unit	Mobile + Doors	Mobile + Doors/Locks
A12037	A12038	A12039
Static Unit	Static + Doors	Static + Doors/Locks
A12040	A12041	A12042

12 High 12 Tray Single Unit

H1107mm x W356mm x D460mm



Mobile Unit	Mobile + Doors	Mobile+Drs/Locks
A11037	A11038	A11039
Static Unit	Static + Doors	Static+Drs/Locks
A11040	A11041	A11042

12 High 8 Extra Deep Double

H1107mm x W690mm x D460mm



Mobile Unit	Mobile + Doors	Mobile+Drs/Locks
A12257	A12258	A12259
Static Unit	Static + Doors	Static+Drs/Locks
A12260	A12261	A12262

12 High 4 Extra Deep Single

H1107mm x W356mm x D460mm



Mobile Unit	Mobile + Door	Mobile+Door/Lock
A11109	A11110	A11111
Static Unit	Static + Door	Static+Door/Lock
A11112	A11113	A11114

12 High 3 Jumbo Tray Single

H1107mm x W356mm x D460mm



Mobile Unit	Mobile + Door	Mobile+Door/Lock
A11115	A11116	A11117
Static Unit	Static + Door	Static+Door/Lock
A11118	A11119	A11120

12 High 8 Extra Deep Double

H1107mm x W690mm x D460mm



Mobile Unit	Mobile + Doors	Mobile+Drs/Locks
A12251	A12252	A12253
Static Unit	Static + Doors	Static+Drs/Locks
A12254	A12255	A12256

12 High Open Shelf Single

H1107mm x W356mm x D460mm



Mobile Unit	Static Unit
A21037	A21038

12 High Single Cupboard

H1107mm x W356mm x D480mm



Mobile + Doors	Mobile + Doors/Locks
A21039	A21041
Static + Doors	Static + Doors/Locks
A21040	A21042

12 High 6 Jumbo Tray Double

H1107mm x W690mm x D460mm



Mobile Unit	Mobile + Doors	Mobile+Drs/Locks
A12311	A12312	A12313
Static Unit	Static + Doors	Static+Drs/Locks
A12314	A12315	A12316

12 High 6 Jumbo Tray Double

H1107mm x W690mm x D460mm



Mobile Unit		Mobile + Doors		Mobile+Drs/Locks	
A12056		A12264		A12265	
Static Unit		Static + Doors		Static+Drs/Locks	
A12055		A12266		A12267	

12 High 16 Combination Tray

H1107mm x W690mm x D460mm



12 x Shallow & 4 x Extra Deep trays

Mobile Unit		Mobile + Doors		Mobile+Drs/Locks	
A12293		A12294		A12295	
Static Unit		Static + Doors		Static+Drs/Locks	
A12296		A12297		A12298	

12 High 15 Combination Tray

H1107mm x W690mm x D460mm



12 x Shallow & 3 x Jumbo trays

Mobile Unit		Mobile + Doors		Mobile+Drs/Locks	
A12299		A12300		A12301	
Static Unit		Static + Doors		Static+Drs/Locks	
A12302		A12303		A12304	

12 High 7 Combi. Tray Double

H1107mm x W690mm x D460mm



4 x Extra Deep & 3 x Jumbo trays

Mobile Unit		Mobile + Doors		Mobile+Drs/Locks	
A12281		A12282		A12283	
Static Unit		Static + Doors		Static+Drs/Locks	
A12284		A12285		A12286	

12 High 12 Tray+ Shelves

H1107mm x W690mm x D460mm



Mobile Unit		Mobile + Doors		Mobile+Drs/Locks	
A12305		A12306		A12307	
Static Unit		Static + Doors		Static+Drs/Locks	
A12308		A12309		A12310	

12 High 12 Tray Triple

H1107mm x W1024mm x D480mm



Mobile + Doors		Mobile + Doors/Locks	
A13270		A13271	
Static + Doors		Static + Doors/Locks	
A13272		A13273	

12 High Open Shelf Double Unit

H1107mm x W690mm x D460mm



Mobile Unit		Static Unit	
A22037		A22038	

12 High Double Cupboard Unit

H1107mm x W690mm x D480mm



Mobile + Doors		Mobile + Doors/Locks	
A22039		A22041	
Static + Doors		Static + Doors/Locks	
A22040		A22042	

12 High Open Shelf Triple Unit

H1107mm x W1024mm x D460mm



Mobile Unit		Static Unit	
A23059		A23060	

12 High Open Shelf Quad Unit

H1107mm x W1358mm x D480mm



Mobile Unit		Static Unit	
A14397		A14400	

12 High 36 Tray Triple Unit

H1107mm x W1024mm x D460mm

Mobile Unit	
A13037	
Mobile + Doors	
A13038	
Mobile + Drs/Locks	
A13039	

Static Unit	
A13040	
Static + Doors	
A13041	
Static + Drs/Locks	
A13042	



12 High 9 Jumbo Tray Triple

H1107mm x W1024mm x D460mm

Mobile Unit	
A13056	
Mobile + Doors	
A13248	
Mobile + Drs/Locks	
A13249	

Static Unit	
A13055	
Static + Doors	
A13250	
Static + Drs/Locks	
A13251	



Fixed shelves

12 High 12 Extra Deep Tray Triple

H1107mm x W1024mm x D460mm

Mobile Unit	
A13243	
Mobile + Doors	
A13244	
Mobile + Drs/Locks	
A13245	

Static Unit	
A13246	
Static + Doors	
A13061	
Static + Drs/Locks	
A13247	



12 High 24 Tray + Shelves Triple

H1107mm x W1024mm x D460mm

Mobile Unit	
A13264	
Mobile + Doors	
A13265	
Mobile + Drs/Locks	
A13266	

Static Unit	
A13267	
Static + Doors	
A13268	
Static + Drs/Locks	
A13269	



12 High 12 Tray Triple with Shelves

H1107mm x W1024mm x D460mm

Mobile Unit	
A13258	
Mobile + Doors	
A13259	
Mobile + Drs/Locks	
A13260	

Static Unit	
A13261	
Static + Doors	
A13262	
Static + Drs/Locks	
A13263	



Optional door covers trays only



12 High Triple Cupboard

H1107mm x W1024mm x D480mm

Mobile + Doors	
A23061	
Mobile + Drs/Locks	
A23062	

Static + Doors	
A23063	
Static + Drs/Locks	
A23064	



12 High 24 Tray Quad with Shelves

H1107mm x W1358mm x D460mm

Mobile Unit	
A14427	
Mobile + Doors	
A14428	
Mobile + Drs/Locks	
A14429	

Static Unit	
A14430	
Static + Doors	
A14431	
Static + Drs/Locks	
A14432	



12 High 24 Tray Quad with Shelves

H1107mm x W1358mm x D480mm

Mobile + Doors	
A14433	
Mobile + Drs/Locks	
A14434	

Static + Doors	
A14435	
Static + Drs/Locks	
A14436	



12 High 24 Tray Quad with Shelves

H1107mm x W1358mm x D460mm

Mobile Unit	
A14409	
Mobile + Doors	
A14410	
Mobile + Drs/Locks	
A14411	
Static Unit	
A14412	
Static + Doors	
A14413	
Static + Drs/Locks	
A14414	



12 High 48 Tray Quad Unit

H1107mm x W1358mm x D460mm

Mobile Unit	
A14037	
Mobile + Doors	
A14038	
Mobile + Drs/Locks	
A14039	
Static Unit	
A14040	
Static + Doors	
A14041	
Static + Drs/Locks	
A14042	



12 High 16 Extra Deep Tray Quad

H1107mm x W1358mm x D460mm

Mobile Unit	
A14059	
Mobile + Doors	
A14357	
Mobile + Drs/Locks	
A14358	
Static Unit	
A14359	
Static + Doors	
A14360	
Static + Drs/Locks	
A14361	



12 High 16 Extra Deep Tray Quad

H1107mm x W1358mm x D460mm

Mobile Unit	
A14380	
Mobile + Doors	
A14381	
Mobile + Drs/Locks	
A14382	
Static Unit	
A14383	
Static + Doors	
A14384	
Static + Drs/Locks	
A14385	



12 High 12 Jumbo Tray Quad Unit

H1107mm x W1358mm x D460mm

Mobile Unit	
A14362	
Mobile + Doors	
A14363	
Mobile + Drs/Locks	
A14364	
Static Unit	
A14365	
Static + Doors	
A14366	
Static + Drs/Locks	
A14367	



12 High 12 Jumbo Tray Quad Unit

H1107mm x W1358mm x D460mm

Mobile Unit	
A14055	
Mobile + Doors	
A14386	
Mobile + Drs/Locks	
A14387	
Static Unit	
A14388	
Static + Doors	
A14389	
Static + Drs/Locks	
A14390	



12 High 8 Extra Deep Tray Quad with Shelves

H1107mm x W1358mm x D460mm

Mobile Unit	
A14391	
Mobile + Doors	
A14392	
Mobile + Drs/Locks	
A14393	
Static Unit	
A14394	
Static + Doors	
A14395	
Static + Drs/Locks	
A14396	



12 High 6 Jumbo Tray Quad with Shelves

H1107mm x W1358mm x D460mm

Mobile Unit	
A14403	
Mobile + Doors	
A14404	
Mobile + Drs/Locks	
A14405	
Static Unit	
A14406	
Static + Doors	
A14407	
Static + Drs/Locks	
A14408	



13 High 6 Deep Tray Single

H1189mm x W356mm x D460mm



Mobile Unit	
A11103	
Mobile + Doors	
A11104	
Mobile + Drs/Locks	
A11105	
Static Unit	
A11106	
Static + Doors	
A11107	
Static + Drs/Locks	
A11108	

13 High 12 Deep Tray Double

H1189mm x W690mm x D460mm



Mobile Unit	
A12245	
Mobile + Doors	
A12246	
Mobile + Drs/Locks	
A12247	
Static Unit	
A12248	
Static + Doors	
A12249	
Static + Drs/Locks	
A12250	

13 High 12 Deep Tray Double

H1189mm x W690mm x D460mm



Mobile Unit	
A12239	
Mobile + Doors	
A12240	
Mobile + Drs/Locks	
A12241	
Static Unit	
A12242	
Static + Doors	
A12243	
Static + Drs/Locks	
A12244	£356.00

13 High 19 Combi. Tray Double

H1189mm x W690mm x D460mm

Mobile Unit	
A12287	
Mobile + Doors	
A12288	
Mobile + Drs/Locks	
A12289	
Static Unit	
A12290	
Static + Doors	
A12291	
Static + Drs/Locks	
A12292	



13 x Shallow, 6 Deep trays

13 High 10 Combi. Tray Double

H1189mm x W690mm x D460mm

Mobile Unit	
A12269	
Mobile + Doors	
A12270	
Mobile + Drs/Locks	
A12271	
Static Unit	
A12272	
Static + Doors	
A12273	
Static + Drs/Locks	
A12274	



6 x Deep, 4 x Extra Deep trays

13 High 9 Combi. Tray Double

H1189mm x W690mm x D460mm

Mobile Unit	
A12275	
Mobile + Doors	
A12276	
Mobile + Drs/Locks	
A12277	
Static Unit	
A12278	
Static + Doors	
A12279	
Static + Drs/Locks	
A12280	



6 x Deep, 3 x Jumbo Deep trays

13 High 18 Deep Tray Triple

H1189mm x W1024mm x D460mm

Mobile Unit	
A13237	
Mobile + Doors	
A13238	
Mobile + Drs/Locks	
A13239	
Static Unit	
A13240	
Static + Doors	
A13241	
Static + Drs/Locks	
A13242	



13 High 13 Combination Tray Triple

H1189mm x W1024mm x D460mm

Mobile Unit	
A13252	
Mobile + Doors	
A13253	
Mobile + Drs/Locks	
A13254	
Static Unit	
A13255	
Static + Doors	
A13256	
Static + Drs/Locks	
A13257	



6 x Deep, 4 x Extra Deep & 3 x Jumbo trays

13 High 24 Deep Tray Quad Unit

H1189mm x W1358mm x D460mm



Mobile Unit	Mobile + Doors	Mobile+Drs/Locks
A14350	A14351	A14352
Static Unit	Static + Doors	Static+Drs/Locks
A14353	A14354	A14355



13 High 24 Deep Tray Quad Unit

H1189mm x W1358mm x D460mm



Mobile Unit	Mobile + Doors	Mobile+Drs/Locks
A14374	A14375	A14376
Static Unit	Static + Doors	Static+Drs/Locks
A14377	A14378	A14379



13 High 12 Deep Tray Triple with Shelves

H1189mm x W1024mm x D460mm



Mobile Unit	Mobile + Doors	Mobile+Drs/Locks
A13274	A13275	A13276
Static Unit	Static + Doors	Static+Drs/Locks
A13277	A13278	A13279



13 High 12 Deep Tray Quad with Shelves

H1189mm x W1358mm x D460mm



Mobile Unit	Mobile + Doors	Mobile+Drs/Locks
A14368	A14369	A14370
Static Unit	Static + Doors	Static+Drs/Locks
A14371	A14372	A14373



13 High 38 Combi. Tray Quad Unit

H1189mm x W1358mm x D460mm



26 x Shallow, 12 Deep Trays

Mobile Unit	Mobile + Doors	Mobile+Drs/Locks
A14415	A14416	A14417
Static Unit	Static + Doors	Static+Drs/Locks
A14418	A14419	A14420



13 High 12 Deep Tray Quad with Shelves

H1189mm x W1358mm x D460mm



Mobile Unit	Mobile + Doors	Mobile+Drs/Locks
A14421	A14422	A14423
Static Unit	Static + Doors	Static+Drs/Locks
A14424	A14425	A14426



PREMIUM A3 TRAY UNITS

A3 Mobile 12 Tray Double

H689mm x W974mm x D525mm



A3 Mobile 12 Tray Double	
A17002	

A3 Trays available in Blue or Red.



Choice of finishes



A3 Mobile 6 Tray Single

H689mm x W500mm x D525mm



A3 Mobile 6 Tray Single	
A17001	

A3 Mobile 8 Tray Single

H903mm x W500mm x D525mm



A3 Mobile 8 Tray Single	
A17003	

A3 Mobile 10 Tray Single

H1099mm x W500mm x D525mm



A3 Mobile 10 Tray Single	
A17005	

A3 Mobile 16 Tray Double

H903mm x W974mm x D525mm



A3 Mobile 16 Tray Double	
A17004	

A3 Mobile 20 Tray Double

H1099mm x W974mm x D525mm



A3 Mobile 20 Tray Double	
A17006	

15 Extra Deep Tray Triple

H1428mm x W1024mm x D460mm



15 Extra Deep Tray Open Unit	
A13281	
15 Extra Deep Tray with Doors	
A13282	
15 Extra Deep Tray with Doors & Lock	
A13283	

Choice of finishes



5 Extra Deep Tray Single

H1428mm x W356mm x D460mm



5 Extra Deep Tray Open Unit	
A11124	
5 Extra Deep Tray - Door	
A11125	
5 Extra Deep Tray - Door & Lock	
A11126	

10 Extra Deep Tray Double

H1428mm x W690mm x D460mm



10 Extra Deep Tray Open Unit	
A12320	
10 Extra Deep Tray - Door	
A12321	
10 Extra Deep Tray - Door & Lock	
A12322	

Single Cupboard

H1428mm x W356mm x D480mm



1428mm High Single Cupboard	
A21065	
1428mm High Single Cupboard with Lock	
A21066	

Double Cupboard

H1428mm x W690mm x D480mm



1428mm High Double Cupboard	
A22065	
1428mm High Double Cupboard with Lock	
A22066	

Triple Cupboard

H1428mm x W1024mm x D480mm



1428mm High Triple Cupboard	
A23092	
1428mm High Triple Cupboard with Lock	
A23093	

16 Tray Single

H1510mm x W356mm x D460mm



16 Tray Single	
A11136	
16 Tray Single with Door	
A11137	
16 Tray Single with Door & Lock	
A11138	

32 Tray Double

H1510mm x W690mm x D460mm



32 Tray Double	
A12329	
32 Tray Double with Doors	
A12330	
32 Tray Double with Doors & Locks	
A12331	

48 Tray Triple

H1510mm x W1024mm x D460mm



48 Tray Triple	
A13320	
48 Tray Triple with Doors	
A13321	
48 Tray Triple with Doors & Locks	
A13322	

24 Tray Open Triple

H1510mm x W1024mm x D460mm



24 Tray Open Triple	
A13069	

24 Tray Triple Half Cupboard

H1510mm x W1024mm x D480mm



24 Tray Triple Half Cupboard	
A13318	
24 Tray Triple Half Cupboard with Locks	
A13319	

24 Tray Triple Cupboard

H1510mm x W1024mm x D480mm



24 Tray Triple Cupboard	
A13071	
24 Tray Triple Cupboard with Locks	
A13317	

4 Jumbo Tray Single

H1510mm x W356mm x D460mm



4 Jumbo Tray Single	
A11127	
4 Jumbo Tray Single with Door	
A11128	
4 Jumbo Tray Single with Door & Lock	
A11129	

8 Jumbo Tray Double

H1510mm x W690mm x D460mm



8 Jumbo Tray Double	
A12317	
8 Jumbo Tray Double with Doors	
A12318	
8 Jumbo Tray Double with Doors & Locks	
A12319	

12 Jumbo Tray Triple

H1510mm x W1024mm x D460mm



12 Jumbo Tray Triple	
A13284	
12 Jumbo Tray Triple with Doors	
A13285	
12 Jumbo Tray Triple with Doors & Locks	
A13286	

Single Cupboard

H1510mm x W356mm x D480mm



1510mm High Single Cupboard	
A21067	
1510mm High Single Cupboard with Lock	
A21068	

Double Cupboard

H1510mm x W690mm x D480mm



1510mm High Double Cupboard	
A22067	
1510mm High Double Cupboard with Lock	
A22068	

Triple Cupboard

H1510mm x W1024mm x D480mm



1510mm High Triple Cupboard	
A23094	
1510mm High Triple Cupboard with Lock	
A23095	

Triple Divided Cupboard

H1510mm x W1024mm x D480mm



1510mm High Triple Divided Cupboard	
A23001	
1510mm High Triple Cupboard with Lock	
A23098	

36 Tray Triple

H1674mm x W1024mm x D460mm



1674mm High 36 Tray Triple	
A13064	
1674mm High 36 Tray Triple with Doors	
A13314	
1674mm High 36 Tray Triple - Drs/Locks	
A13315	

6 Extra Deep Tray Single

H1674mm x W356mm x D460mm



6 Extra Deep Tray Open Unit	
A11121	
6 Extra Deep Tray with Door	
A11122	
6 Extra Deep Tray - Door & Lock	
A11123	

12 Extra Deep Tray Double

H1674mm x W690mm x D460mm



12 Extra Deep Tray Open Unit	
A12323	
12 Extra Deep Tray with Doors	
A12324	
12 Extra Deep Tray - Doors & Locks	
A12325	

18 Extra Deep Tray Triple

H1674mm x W1024mm x D460mm



18 Extra Deep Tray Open Unit	
A13058	
18 Extra Deep Tray - Doors	
A13059	
18 Extra Deep Tray - Doors & Locks	
A13280	

Single Cupboard

H1674mm x W356mm x D480mm



1674mm High Single Cupboard	
A21069	
1674mm High Single Cupboard with Lock	
A21070	

Double Cupboard

H1674mm x W690mm x D480mm



1674mm High Double Cupboard	
A22069	
1674mm High Double Cupboard with Lock	
A22070	

Triple Cupboard

H1674mm x W1024mm x D480mm



1674mm High Triple Cupboard	
A23096	
1674mm High Triple Cupboard with Lock	
A23097	

20 Tray Triple Cupboard

H1838mm x W1024mm x D480mm



20 Tray Triple Cupboard	
A13066	
20 Tray Triple Cupboard with Locks	
A13316	

20 Tray Single

H1838mm x W356mm x D460mm



20 Tray Single	
A11130	
20 Tray Single with Doors	
A11131	
20 Tray Single with Door & Lock	
A11132	

40 Tray Double

H1838mm x W690mm x D460mm



40 Tray Double	
A12326	

40 Tray Cupboard

H1838mm x W690mm x D480mm



40 Tray Cupboard	
A12327	
40 Tray Cupboard with Locks	
A12328	

60 Tray Triple

H1838mm x W1024mm x D460mm



60 Tray Open Unit	
A13068	

60 Tray Triple Cupboard

H1838mm x W1024mm x D480mm



60 Tray Cupboard	
A13312	
60 Tray Cupboard with Locks	
A13313	

Single Cupboard

H1838mm x W356mm x D480mm



1838mm High Single Cupboard	
A21071	
1838mm High Single Cupboard with Lock	
A21072	

Double Cupboard

H1838mm x W690mm x D480mm



1838mm High Double Cupboard	
A22071	
1838mm High Double Cupboard with Lock	
A22072	

Triple Cupboard

H1838mm x W1024mm x D480mm



1838mm High Triple Cupboard	
A23099	
1838mm High Triple Cupboard with Lock	
A23100	

12 Tray Cupboard - Full Doors

H1838mm x W690mm x D480mm



1838mm High 12 Tray Cupboard - Full Doors	
A12332	
1838mm High 12 Tray Cupboard with Lock	
A12333	



12 Tray Cupboard - Half Doors

H1838mm x W690mm x D480mm



1838mm High 12 Tray Cupboard - Half Doors	
A12334	
1838mm High 12 Tray Cupboard - Half Doors with Lock	
A12335	



16 Tray Cupboard - Full Doors

H1838mm x W690mm x D480mm



1838mm High 16 Tray Cupboard - Full Doors	
A12336	
1838mm High 16 Tray Cupboard with Lock	
A12337	



16 Tray Cupboard - Half Doors

H1838mm x W690mm x D480mm



1838mm High 16 Tray Cupboard - Half Doors	
A12338	
1838mm High 16 Tray Cupboard - Half Doors with Lock	
A12339	



All Gratnells Tray are included in the price

Choice of Gratnells Tray Colours



- Red
- Yellow
- Blue
- Green
- Cyan
- Pink
- Orange
- Lime
- Blueberry Jelly
- Strawberry Jelly
- Kiwi Jelly
- Purple
- Grape Jelly
- Lemon Jelly
- Light Grey
- Clear

36 Tray Cupboard

H1838mm x W1024mm x D480mm



1838mm High 36 Tray Cupboard	
A13327	
1838mm High 36 Tray Cupboard with Locks	
A13328	



21 Tray Cupboard

H1838mm x W1024mm x D480mm



1838mm High 21 Tray Cupboard - Full Doors	
A13325	
1838mm High 21 Tray Cupboard - Full Doors with Locks	
A13326	





CERTWOOD

SHATTERPROOF TRAYS

These tray units are fitted with the Glide & Tilt Runner System which holds trays in an angled position allowing easy & safe access to the tray contents.

Additionally, all units include **Certwood crystal clear trays** that are moulded in 'Super tuff shatterproof' High Impact Polystyrene (HIPS). Units are fully mobile with locking castors. Supplied in a Beech finish.

- Glide & Tilt Runners
- Super-Tuff Shatterproof
- Crystal Clear Trays*

**The ONLY 100% guaranteed, glass clear trays available to view contents easily.*



Crystal Clear Tray sizes



Shallow

Deep

Jumbo

Crystal Clear 6 Tray Single

H661mm x W353mm x D460mm



Crystal Clear 6 Tray Single

B18021	Mobile on castors
---------------	-------------------

Crystal Clear 12 Tray Double

H661mm x W684mm x D460mm



Crystal Clear 12 Tray Double

B18017	Mobile on castors
---------------	-------------------

Crystal Clear 18 Tray Triple

H661mm x W1015mm x D460mm



Crystal Clear 18 Tray Triple

B18024	Mobile on castors
---------------	-------------------

Crystal Clear 24 Tray Quad

H661mm x W1346mm x D460mm



Crystal Clear 24 Tray Quad

B18025	Mobile on castors
---------------	-------------------

Crystal Clear 7 Tray Single

H752mm x W353mm x D460mm



Crystal Clear 7 Tray Single		
B18026	Mobile on castors	

Crystal Clear 14 Tray Double

H752mm x W684mm x D460mm



Crystal Clear 14 Tray Double		
B18027	Mobile on castors	

Crystal Clear 21 Tray Triple

H752mm x W1015mm x D460mm



Crystal Clear 21 Tray Triple		
B18028	Mobile on castors	

Crystal Clear 28 Tray Quad

H752mm x W1346mm x D460mm



Crystal Clear 28 Tray Quad		
B18029	Mobile on castors	

Crystal Clear 8 Tray Single

H844mm x W356mm x D460mm



Crystal Clear 8 Tray Single		
B18030	Mobile on castors	

Crystal Clear 16 Tray Double

H844mm x W684mm x D460mm



Crystal Clear 16 Tray Double		
B18031	Mobile on castors	

Crystal Clear 24 Tray Triple

H844mm x W1015mm x D460mm



Crystal Clear 24 Tray Triple		
B18022	Mobile on castors	

Crystal Clear 32 Tray Quad

H844mm x W1346mm x D460mm



Crystal Clear 32 Tray Quad		
B18016	Mobile on castors	

Crystal Clear 36 Tray Triple

H1257mm x W1015mm x D460mm



Delivered in two sections.
Supplied with all fittings.

Crystal Clear 36 Tray Triple		
B18020	Mobile on castors	

Crystal Clear 42 Tray Triple

H1440mm x W1024mm x D460mm



Delivered in two sections.
Supplied with all fittings.

Crystal Clear 42 Tray Triple		
B18032	Mobile on castors	

- Glide & Tilt Runners
- Super-Tuff Shatterproof
- Crystal Clear Trays*

**The ONLY 100% guaranteed, glass clear trays available to view contents easily.*



CERTWOOD
SHATTERPROOF TRAYS

Crystal Clear 48 Tray Triple

H1623mm x W1015mm x D460mm



Delivered in two sections.
Supplied with all fittings.

Crystal Clear 48 Tray Triple		
B18033	Mobile on castors	



Crystal Clear 18 Deep Tray Triple

H1189mm x W1024mm x D460mm

Crystal Clear 18 Deep Tray Triple		
B18034	Mobile on castors	

- Glide & Tilt Runners
- Super-Tuff Shatterproof
- Crystal Clear Trays*

*The ONLY 100% guaranteed, glass clear trays available to view contents easily.



CERTWOOD

SHATTERPROOF TRAYS

Crystal Clear 6 Deep Tray Triple

H438mm x W1024mm x D460mm



Crystal Clear 6 Deep Tray Triple		
B18038	Mobile on castors	

Crystal Clear 9 Deep Tray Triple

H615mm x W1024mm x D460mm



Crystal Clear 9 Deep Tray Triple		
B18037	Mobile on castors	

Crystal Clear 12 Deep Tray Triple

H779mm x W1024mm x D460mm



Crystal Clear 12 Deep Tray Triple		
B18036	Mobile on castors	

Crystal Clear 15 Deep Tray Triple

H943mm x W1024mm x D460mm



Crystal Clear 15 Deep Tray Triple		
B18035	Mobile on castors	

Crystal Clear 3 Tray - Variety

H697mm x W356mm x D460mm



Trays includes:
1 x Shallow
1 x Deep
1 x Jumbo

Crystal Clear 3 Tray Variety Single

B18040	Mobile on castors	
---------------	-------------------	--

Crystal Clear 6 Tray Double - Variety

H697mm x W690mm x D460mm



Trays includes:
2 x Shallow
2 x Deep
2 x Jumbo

Crystal Clear 6 Tray Variety Double

B18041	Mobile on castors	
---------------	-------------------	--

Crystal Clear 9 Tray Triple - Variety

H697mm x W1024mm x D460mm



Trays includes:
3 x Shallow
3 x Deep
3 x Jumbo

Crystal Clear 9 Tray Variety Triple

B18042	Mobile on castors	
---------------	-------------------	--



Crystal Clear 12 Tray Quad - Variety

H697mm x W1358mm x D460mm

Trays includes:
4 x Shallow
4 x Deep
4 x Jumbo

Crystal Clear 12 Tray Variety Quad

B18043	Mobile on castors	
---------------	-------------------	--

- Glide & Tilt Runners
- Super-Tuff Shatterproof
- Crystal Clear Trays*

**The ONLY 100% guaranteed, glass clear trays available to view contents easily.*



Crystal Clear 4 Tray - Variety

H1021mm x W356mm x D460mm



Trays includes:
1 x Shallow
1 x Deep
2 x Jumbo

Crystal Clear 4 Tray Variety Single

B18044	Mobile on castors	
---------------	-------------------	--

Crystal Clear 8 Tray Variety Double

H1021mm x W690mm x D460mm



Trays includes:
2 x Shallow
2 x Deep
4 x Jumbo

Crystal Clear 8 Tray Variety Double

B18046	Mobile on castors	
---------------	-------------------	--

Crystal Clear 12 Tray Variety Triple

H1021mm x W1024mm x D460mm



Trays includes:
3 x Shallow
3 x Deep
6 x Jumbo

Crystal Clear 12 Tray Variety Triple

B18045	Mobile on castors	
---------------	-------------------	--



Crystal Clear 16 Tray Variety Quad

H1021mm x W1358mm x D460mm

Trays includes:
4 x Shallow
4 x Deep
8 x Jumbo

Crystal Clear 16 Tray Variety Quad

B18023	Mobile on castors	
---------------	-------------------	--



Crystal Clear 24 Deep Tray Quad

H1189mm x W1358mm x D460mm



Crystal Clear 24 Deep Tray Quad		
B18039	Mobile on castors	

- Glide & Tilt Runners
- Super-Tuff Shatterproof
- Crystal Clear Trays*

**The ONLY 100% guaranteed, glass clear trays available to view contents easily.*



Crystal Clear 8 Deep Tray Quad

H438mm x W1358mm x D460mm



Crystal Clear 8 Deep Tray Quad		
B18049	Mobile on castors	

Crystal Clear 12 Deep Tray Quad

H615mm x W1358mm x D460mm



Crystal Clear 12 Deep Tray Quad		
B18048	Mobile on castors	

Crystal Clear 16 Deep Tray Quad

H779mm x W1358mm x D460mm



Crystal Clear 16 Deep Tray Quad		
B18019	Mobile on castors	

Crystal Clear 20 Deep Tray Quad

H1025mm x W1358mm x D460mm



Crystal Clear 20 Deep Tray Quad		
B18050	Mobile on castors	

Crystal Clear 2 Jumbo
H779mm x W356mm x D460mm



Crystal Clear 2 Jumbo Tray Single
B18051 Mobile on castors

Crystal Clear 4 Jumbo Double
H779mm x W690mm x D460mm



Crystal Clear 4 Jumbo Tray Double
B18054 Mobile on castors

Crystal Clear 6 Jumbo Tray Triple
H779mm x W1024mm x D460mm



Crystal Clear 6 Jumbo Tray Triple
B18057 Mobile on castors



Crystal Clear 8 Jumbo Tray Quad
H779mm x W1358mm x D460mm

Crystal Clear 8 Jumbo Tray Quad
B18018 Mobile on castors

Crystal Clear 3 Jumbo
H1107mm x W356mm x D460mm



Crystal Clear 3 Jumbo Tray Single
B18052 Mobile on castors

Crystal Clear 6 Jumbo Double
H1107mm x W690mm x D460mm



Crystal Clear 6 Jumbo Tray Double
B18055 Mobile on castors

Crystal Clear 9 Jumbo Tray Triple
H1107mm x W1024mm x D460mm



Crystal Clear 9 Jumbo Tray Triple
B18058 Mobile on castors



Crystal Clear 12 Jumbo Tray Quad
H1107mm x W1358mm x D460mm

Crystal Clear 12 Jumbo Tray Quad
B18060 Mobile on castors

- Glide & Tilt Runners
- Super-Tuff Shatterproof
- Crystal Clear Trays*

**The ONLY 100% guaranteed, glass clear trays available to view contents easily.*



Crystal Clear 4 Jumbo
H1510mm x W356mm x D460mm



Crystal Clear 4 Jumbo Tray Single
B18053 | Mobile on castors |

Crystal Clear 8 Jumbo Tray
H1510mm x W690mm x D460mm



Crystal Clear 8 Jumbo Tray Double
B18056 | Mobile on castors |

Crystal Clear 12 Jumbo Triple
H1510mm x W1024mm x D460mm



Crystal Clear 12 Jumbo Tray Triple
B18059 | Mobile on castors |



Crystal Clear 16 Jumbo Tray Quad
H1510mm x W1358mm x D460mm

Crystal Clear 16 Jumbo Tray Triple
B18047 | Mobile on castors |

- Glide & Tilt Runners
- Super-Tuff Shatterproof
- Crystal Clear Trays*

**The ONLY 100% guaranteed, glass clear trays available to view contents easily.*



500MM WIDE CUPBOARDS

500mm Wide Cupboard

Superior quality, 500mm wide cupboards, constructed using 18mm solid MDF wood, chrome handles & quality hinges.

All cupboards are available from 600mm to 1800mm high.

Delivered fully assembled & available in a choice of colours. Available with or without door locks.

Choice of finishes



- Superior quality cupboards
- 18mm solid wood MDF
- Adjustable shelves
- Lock option available
- Choice of finishes

Products shown in beech finish.

1800mm High Cupboard

H1800mm x W500mm x D480mm



Shelves:
1 x Fixed
4 x Adjustable

1800mm High Cupboard - without Locks	
A21043	
1800mm High Cupboard with Locks	
A21044	

1500mm High Cupboard

H1500mm x W500mm x D480mm



Shelves:
1 x Fixed
2 x Adjustable

1500mm High Cupboard - without Locks	
A21045	
1500mm High Cupboard with Locks	
A21046	

1200mm High Cupboard

H1200mm x W500mm x D480mm



Shelves:
1 x Fixed
2 x Adjustable

1200mm High Cupboard - without Locks	
A21047	
1200mm High Cupboard with Locks	
A21048	

1100mm High Cupboard

H1100mm x W500mm x D480mm



Shelves:
1 x Fixed
2 x Adjustable

1100mm High Cupboard - without Locks	
A21049	
1100mm High Cupboard with Locks	
A21050	

1000mm High Cupboard

H1000mm x W500mm x D480mm



Shelves:
1 x Fixed
2 x Adjustable

1000mm High Cupboard - without Locks	
A21051	
1000mm High Cupboard with Locks	
A21052	

900mm High Cupboard

H900mm x W500mm x D480mm



Shelves:
1 x Adjustable

900mm High Cupboard - without Locks	
A21053	
900mm High Cupboard with Locks	
A21054	

850mm High Cupboard

H850mm x W500mm x D480mm



Shelves:
1 x Adjustable

850mm High Cupboard - without Locks	
A21055	
850mm High Cupboard with Locks	
A21056	

800mm High Cupboard

H800mm x W500mm x D480mm



Shelves:
1 x Adjustable

800mm High Cupboard - without Locks	
A21057	
800mm High Cupboard with Locks	
A21058	

750mm High Cupboard

H750mm x W500mm x D480mm



Shelves:
1 x Adjustable

750mm High Cupboard - without Locks	
A21059	
750mm High Cupboard with Locks	
A21060	

700mm High Cupboard

H700mm x W500mm x D480mm



Shelves:
1 x Adjustable

700mm High Cupboard - without Locks	
A21061	
700mm High Cupboard with Locks	
A21062	

600mm High Cupboard

H600mm x W500mm x D480mm



Shelves:
1 x Adjustable

600mm High Cupboard - without Locks	
A21063	
600mm High Cupboard with Locks	
A21064	

750MM WIDE CUPBOARDS

750mm Wide Cupboard

Superior quality, 750mm wide cupboards, constructed using 18mm solid MDF wood, chrome handles & quality hinges.

All cupboards are available from 600mm to 1800mm high.

Delivered fully assembled & available in a choice of colours. Available with or without door locks.

Choice of finishes



- Superior quality cupboards
- 18mm solid wood MDF
- Adjustable shelves
- Lock option available
- Choice of finishes

Products shown in beech finish.

1800mm High Cupboard

H1800mm x W750mm x D480mm



Shelves:
1 x Fixed
4 x Adjustable

1800mm High Cupboard - without Locks	
A22043	
1800mm High Cupboard with Locks	
A22044	

1500mm High Cupboard

H1500mm x W750mm x D480mm



Shelves:
1 x Fixed
2 x Adjustable

1500mm High Cupboard - without Locks	
A22045	
1500mm High Cupboard with Locks	
A22046	

1200mm High Cupboard

H1200mm x W750mm x D480mm



Shelves:
1 x Fixed
2 x Adjustable

1200mm High Cupboard - without Locks

A22047

1200mm High Cupboard with Locks

A22048

1100mm High Cupboard

H1100mm x W750mm x D480mm



Shelves:
1 x Fixed
2 x Adjustable

1100mm High Cupboard - without Locks

A22049

1100mm High Cupboard with Locks

A22050

1000mm High Cupboard

H1000mm x W750mm x D480mm



Shelves:
1 x Fixed
2 x Adjustable

1000mm High Cupboard - without Locks

A22051

1000mm High Cupboard with Locks

A22052

900mm High Cupboard

H900mm x W750mm x D480mm



Shelves:
1 x Adjustable

900mm High Cupboard - without Locks

A22053

900mm High Cupboard with Locks

A22054

850mm High Cupboard

H850mm x W750mm x D480mm



Shelves:
1 x Adjustable

850mm High Cupboard - without Locks

A22055

850mm High Cupboard with Locks

A22056

800mm High Cupboard

H800mm x W750mm x D480mm



Shelves:
1 x Adjustable

800mm High Cupboard - without Locks

A22057

800mm High Cupboard with Locks

A22058

750mm High Cupboard

H750mm x W750mm x D480mm



Shelves:
1 x Adjustable

750mm High Cupboard - without Locks

A22059

750mm High Cupboard with Locks

A22060

700mm High Cupboard

H700mm x W750mm x D480mm



Shelves:
1 x Adjustable

700mm High Cupboard - without Locks

A22061

700mm High Cupboard with Locks

A22062

600mm High Cupboard

H600mm x W750mm x D480mm



Shelves:
1 x Adjustable

600mm High Cupboard - without Locks

A22063

600mm High Cupboard with Locks

A22064

METRE WIDE CUPBOARDS

Metre Wide Cupboard

Superior quality, metre wide cupboards, constructed using 18mm solid MDF wood, chrome handles & quality hinges.

All cupboards are available from 600mm to 1800mm high.

Delivered fully assembled & available in a choice of colours. Available with or without door locks.

Choice of finishes



- Superior quality cupboards
- 18mm solid wood MDF
- Adjustable shelves
- Lock option available
- Choice of finishes

Products shown in beech finish.

1800mm High Cupboard

H1800mm x W1000mm x D480mm



Shelves:
1 x Fixed
4 x Adjustable

1800mm High Cupboard - without Locks	
A23070	
1800mm High Cupboard with Locks	
A23071	

1500mm High Cupboard

H1500mm x W1000mm x D480mm



Shelves:
1 x Fixed
2 x Adjustable

1500mm High Cupboard - without Locks	
A23072	
1500mm High Cupboard with Locks	
A23073	

1200mm High Cupboard

H1200mm x W1000mm x D480mm



Shelves:
1 x Fixed
2 x Adjustable

1200mm High Cupboard - without Locks	
A23074	
1200mm High Cupboard with Locks	
A23075	

1100mm High Cupboard

H1100mm x W1000mm x D480mm



Shelves:
1 x Fixed
2 x Adjustable

1100mm High Cupboard - without Locks	
A23076	
1100mm High Cupboard with Locks	
A23077	

1000mm High Cupboard

H1000mm x W1000mm x D480mm



Shelves:
1 x Fixed
2 x Adjustable

1000mm High Cupboard - without Locks	
A23078	
1000mm High Cupboard with Locks	
A23079	

900mm High Cupboard

H900mm x W1000mm x D480mm



Shelves:
1 x Adjustable

900mm High Cupboard - without Locks	
A23080	
900mm High Cupboard with Locks	
A23081	

850mm High Cupboard

H850mm x W1000mm x D480mm



Shelves:
1 x Adjustable

850mm High Cupboard - without Locks	
A23082	
850mm High Cupboard with Locks	
A23083	

800mm High Cupboard

H800mm x W1000mm x D480mm



Shelves:
1 x Adjustable

800mm High Cupboard - without Locks	
A23084	
800mm High Cupboard with Locks	
A23085	

750mm High Cupboard

H750mm x W1000mm x D480mm



Shelves:
1 x Adjustable

750mm High Cupboard - without Locks	
A23086	
750mm High Cupboard with Locks	
A23087	

700mm High Cupboard

H700mm x W1000mm x D480mm



Shelves:
1 x Adjustable

700mm High Cupboard - without Locks	
A23088	
700mm High Cupboard with Locks	
A23089	

600mm High Cupboard

H600mm x W1000mm x D480mm



Shelves:
1 x Adjustable

600mm High Cupboard - without Locks	
A23090	
600mm High Cupboard with Locks	
A23091	

PLANCHESTS



FIXED SHELF



SLIDING SHELF



Professional A1 Paper Storage

Professional quality planchests are available as mobile or static. Manufactured in high quality, 18mm solid wood MDF with a choice of five colour finishes. Each unit has metal runners & a bump resistant plastic edges. Due to the weight of these units certain choices will be delivered in 2 or 3 sections that simply connect together with the supplied fittings.

- **Professional quality**
- **Metal runners**
- **Mobile or static**
- **Choice of 5 wood finishes**
- **Guaranteed**



Fitted with metal runners



Stacking modular units

3 Drawer A1 Planchest
H466mm x W1010mm x D705mm



3 Drawer A1 Planchest Mobile	
A52010	

3 Drawer A1 Planchest Static	
A52011	

4 Drawer A1 Planchest
H586mm x W1010mm x D705mm



4 Drawer A1 Planchest Mobile	
A52012	

4 Drawer A1 Planchest Static	
A52013	

5 Drawer A1 Planchest
H706mm x W1010mm x D705mm



5 Drawer A1 Planchest Mobile	
A52014	

5 Drawer A1 Planchest Static	
A52015	

6 Drawer A1 Planchest
H867mm x W1010mm x D705mm



6 Drawer A1 Planchest Mobile	
A52016	

6 Drawer A1 Planchest Static	
A52017	

7 Drawer A1 Planchest
H987mm x W1010mm x D705mm



7 Drawer A1 Planchest Mobile	
A52018	

7 Drawer A1 Planchest Static	
A52019	

8 Drawer A1 Planchest
H1107mm x W1010mm x D705mm



8 Drawer A1 Planchest Mobile	
A52020	

8 Drawer A1 Planchest Static	
A52021	

9 Drawer A1 Planchest
H1227mm x W1010mm x D705mm



9 Drawer A1 Planchest Mobile	
A52022	

9 Drawer A1 Planchest Static	
A52023	

10 Drawer A1 Planchest
H1347mm x W1010mm x D705mm



10 Drawer A1 Planchest Mobile	
A52024	

10 Drawer A1 Planchest Static	
A52025	

3 Fixed Shelves A1 Paper Storage

H466mm x W1010mm x D705mm



3 Fixed Shelves A1 Storage Mobile		3 Fixed Shelves A1 Storage Static	
A52043		A52044	

4 Fixed Shelves A1 Paper Storage

H586mm x W1010mm x D705mm

A1



4 Fixed Shelves A1 Storage Mobile		4 Fixed Shelves A1 Storage Static	
A52045		A52046	

5 Fixed Shelves A1 Paper Storage

H706mm x W1010mm x D705mm



5 Fixed Shelves A1 Storage Mobile		5 Fixed Shelves A1 Storage Static	
A52047		A52048	

6 Fixed Shelves A1 Paper Storage

H867mm x W1010mm x D705mm



6 Fixed Shelves A1 Storage Mobile		6 Fixed Shelves A1 Storage Static	
A52049		A52050	

7 Fixed Shelves A1 Paper Storage

H987mm x W1010mm x D705mm



7 Fixed Shelves A1 Storage Mobile		7 Fixed Shelves A1 Storage Static	
A52051		A52052	

8 Fixed Shelves A1 Paper Storage

H1107mm x W1010mm x D705mm



8 Fixed Shelves A1 Storage Mobile		8 Fixed Shelves A1 Storage Static	
A52053		A52054	

9 Fixed Shelves A1 Paper Storage

H1227mm x W1010mm x D705mm



9 Fixed Shelves A1 Storage Mobile		9 Fixed Shelves A1 Storage Static	
A52055		A52056	

10 Fixed Shelves A1 Paper Storage

H1347mm x W1010mm x D705mm



10 Fixed Shelves A1 Storage Mobile		10 Fixed Shelves A1 Storage Static	
A52057		A52058	

3 Sliding Shelves A1 Paper Storage

H466mm x W1010mm x D705mm



3 Sliding Shelves A1 Storage Mobile	
A52026	

3 Sliding Shelves A1 Storage Static	
A52027	

4 Sliding Shelves A1 Paper Storage

H586mm x W1010mm x D705mm

A1



4 Sliding Shelves A1 Storage Mobile	
A52028	

4 Sliding Shelves A1 Storage Static	
A52029	

5 Sliding Shelves A1 Paper Storage

H706mm x W1010mm x D705mm



5 Sliding Shelves A1 Storage Mobile	
A52030	

5 Sliding Shelves A1 Storage Static	
A52031	

6 Sliding Shelves A1 Paper Storage

H867mm x W1010mm x D705mm



6 Sliding Shelves A1 Storage Mobile	
A52032	

6 Sliding Shelves A1 Storage Static	
A52033	

7 Sliding Shelves A1 Paper Storage

H987mm x W1010mm x D705mm



7 Sliding Shelves A1 Storage Mobile	
A52034	

7 Sliding Shelves A1 Storage Static	
A52035	

8 Sliding Shelves A1 Paper Storage

H1107mm x W1010mm x D705mm



8 Sliding Shelves A1 Storage Mobile	
A52036	

8 Sliding Shelves A1 Storage Static	
A52037	

9 Sliding Shelves A1 Paper Storage

H1227mm x W1010mm x D705mm



9 Sliding Shelves A1 Storage Mobile	
A52038	

9 Sliding Shelves A1 Storage Static	
A52039	

10 Sliding Shelves A1 Paper Storage

H1347mm x W1010mm x D705mm



10 Sliding Shelves A1 Storage Mobile	
A52040	

10 Sliding Shelves A1 Storage Static	
A52041	



Professional A2 Paper Storage

Professional quality planchests are available as mobile or static. Manufactured in high quality, 18mm solid wood MDF with a choice of five colour finishes. Each unit has metal runners & a bump resistant plastic edges. Due to the weight of these units certain choices will be delivered in 2 sections that simply connect together with the supplied fittings.

- Professional quality
- Metal runners
- Mobile or static
- Choice of 5 wood finishes
- Guaranteed



Fitted with metal runners



Stacking modular units

A2

3 Drawer A2 Planchest

H466mm x W542mm x D705mm



4 Drawer A2 Planchest

H586mm x W542mm x D705mm



5 Drawer A2 Planchest

H706mm x W542mm x D705mm



6 Drawer A2 Planchest

H867mm x W542mm x D705mm



7 Drawer A2 Planchest

H987mm x W542mm x D705mm



8 Drawer A2 Planchest

H1107mm x W542mm x D705mm



9 Drawer A2 Planchest

H1227mm x W542mm x D705mm

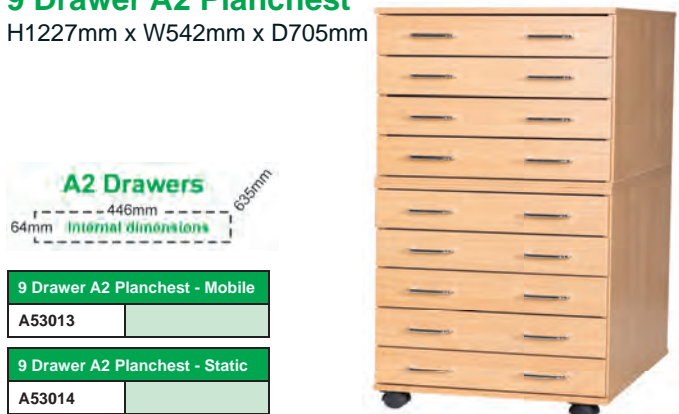

10 Drawer A2 Planchest

H1347mm x W542mm x D705mm

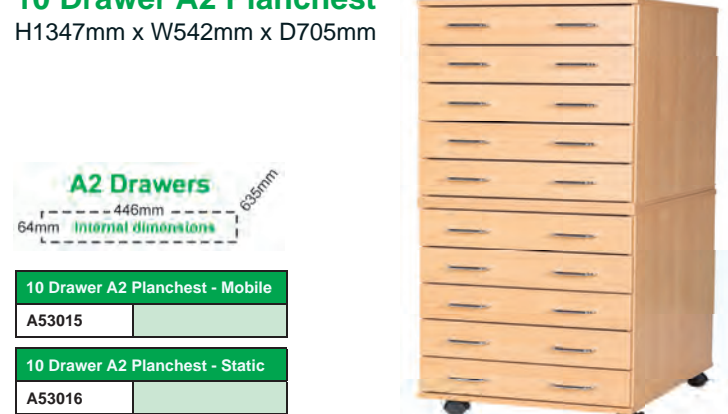

3 Fixed Shelves A2 Paper Storage

H466mm x W542mm x D705mm



4 Fixed Shelves A2 Paper Storage

H586mm x W542mm x D705mm

A2

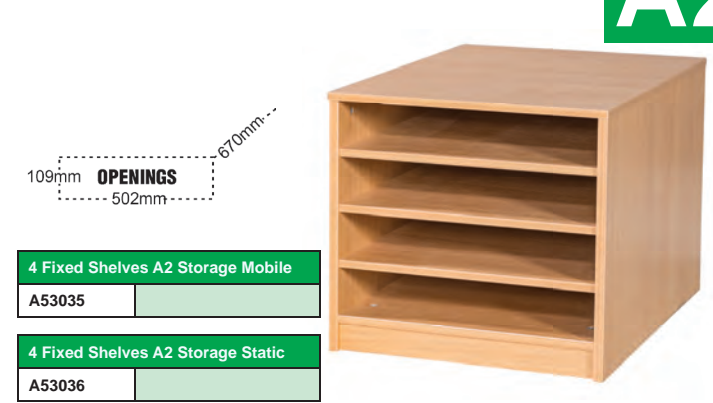

5 Fixed Shelves A2 Paper Storage

H706mm x W542mm x D705mm

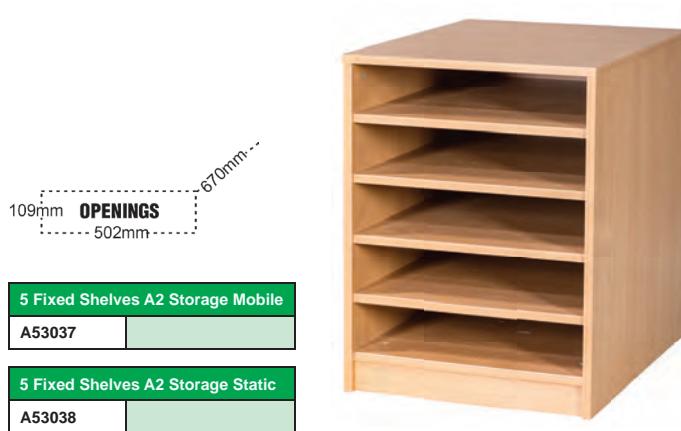

6 Fixed Shelves A2 Paper Storage

H867mm x W542mm x D705mm

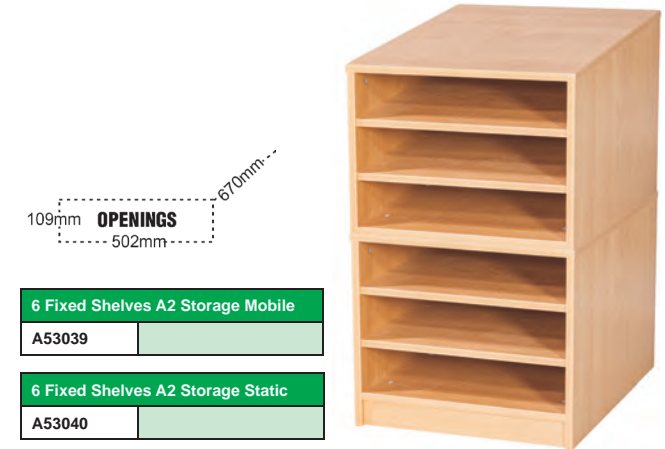

7 Fixed Shelves A2 Paper Storage

H987mm x W542mm x D705mm



8 Fixed Shelves A2 Paper Storage

H1107mm x W542mm x D705mm

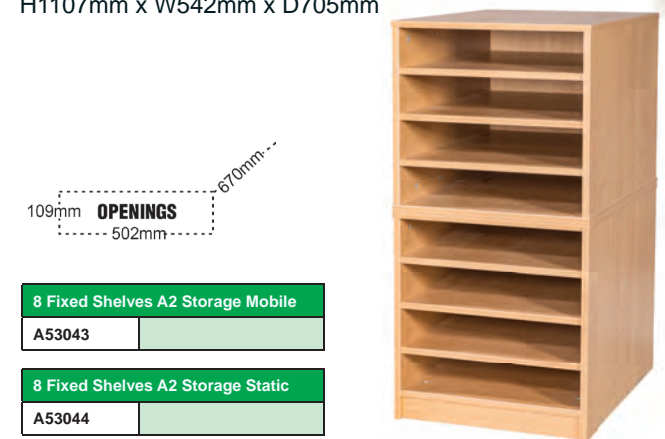

9 Fixed Shelves A2 Paper Storage

H1227mm x W542mm x D705mm



10 Fixed Shelves A2 Paper Storage

H1347mm x W542mm x D705mm

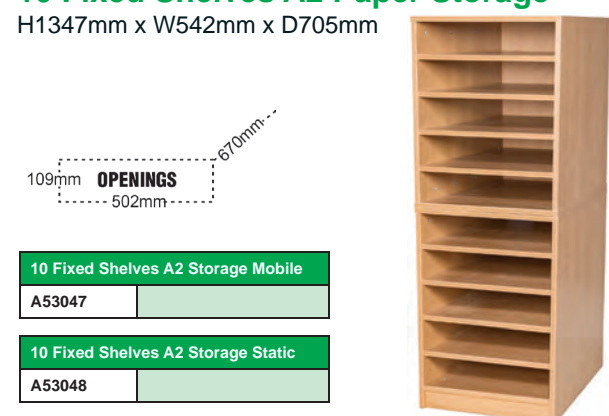

A2

3 Sliding Shelves A2 Paper Storage

H466mm x W542mm x D705mm



3 Sliding Shelves A2 Storage Mobile
A53017

3 Sliding Shelves A2 Storage Static
A53018

4 Sliding Shelves A2 Paper Storage

H586mm x W542mm x D705mm



4 Sliding Shelves A2 Storage Mobile
A53019

4 Sliding Shelf A2 Storage Static
A53020

5 Sliding Shelves A2 Paper Storage

H706mm x W542mm x D705mm



5 Sliding Shelves A2 Storage Mobile
A53021

5 Sliding Shelves A2 Storage Static
A53022

6 Sliding Shelves A2 Paper Storage

H867mm x W542mm x D705mm



6 Sliding Shelves A2 Storage Mobile
A53023

6 Sliding Shelves A2 Storage Static
A53024

7 Sliding Shelves A2 Paper Storage

H987mm x W542mm x D705mm



7 Sliding Shelves A2 Storage Mobile
A53025

7 Sliding Shelves A2 Storage Static
A53026

8 Sliding Shelves A2 Paper Storage

H1107mm x W542mm x D705mm



8 Sliding Shelves A2 Storage Mobile
A53027

8 Sliding Shelves A2 Storage Static
A53028

9 Sliding Shelves A2 Paper Storage

H1227mm x W542mm x D705mm



9 Sliding Shelves A2 Storage Mobile
A53029

9 Sliding Shelves A2 Storage Static
A53030

10 Sliding Shelves A2 Paper Storage

H1347mm x W542mm x D705mm



10 Sliding Shelves A2 Storage Mobile
A53031

10 Sliding Shelves A2 Storage Static
A53032

5 Space A3 Paper Storage

H706mm x W350mm x D460mm

A3

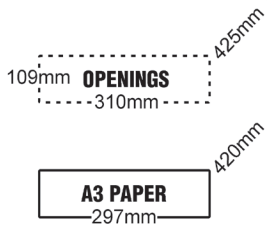

5 Space A3 Paper Storage - Static

A54001

10 Space A3 Paper Storage

H1347mm x W350mm x D460mm

A3

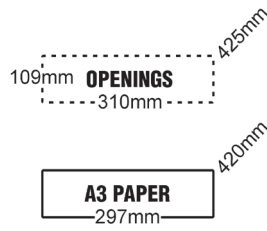

10 Space A3 Paper Storage - Static

A54002

5 Space A4 Paper Storage

H706mm x W260mm x D335mm

A4

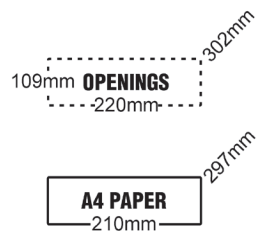

5 Space A4 Paper Storage - Static

A55001

10 Space A4 Paper Storage

H1347mm x W260mm x D335mm

A4

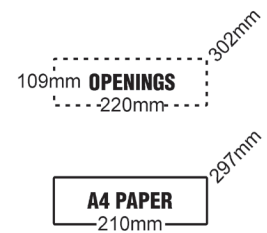

10 Space A4 Paper Storage - Static

A55002



The Ultimate Paper Store

Paper Storage Waterfall

All units are manufactured in a durable, 18mm thick laminate & have 2mm bump resistant, ply effect edges. The range can also be manufactured in Beech, Maple, Oak, Grey or White.

Keep all your paper & card organised & all in one place!



Paper Storage Waterfall

Code	Height	Width	Depth	Price
KCA1WF01	1360mm	1006mm	685mm	



BLANKING UNIT

LIBRARY SEAT WITH CUSHION

750mm WIDE BOOKCASE

LEFT HAND END BOOKCASE

END CAP BOOKCASE

DOUBLE SIDED BOOKCASE

DOUBLE SIDED BOOKCASE

750mm WIDE BOOKCASE

ARCHWAY

Promote learning with



KUBBYCLASS®
Premium Furniture

KubbyClass® Library Furniture

Create your own amazing spaces!

READING NOOK WITH CUSHIONS

750mm WIDE BOOKCASE

750mm WIDE BOOKCASE

INTERNAL CORNER BOOKCASE

SLIMLINE BOOKCASE

RIGHT HAND END BOOKCASE

6 LEAF PETAL TABLE
CODE: KCTAB3
Available in matching colours!

Choice of colours with maple

all maple or beech



KubbyClass® Library Bookcase

Our most popular bookcase in the KubbyClass Library Range. A width of 750mm allows room for plenty of book storage.

Adjustable shelving can be positioned where required & the KubbyClass Safety Shelf comes fitted as standard. Solid construction & guaranteed for 10 years.

Code	Height	Width	Depth	Price
KCBC750	750mm	750mm	350mm	
KCBC1000	1000mm	750mm	350mm	
KCBC1250	1250mm	750mm	350mm	
KCBC1500	1500mm	750mm	350mm	
KCBC1750	1750mm	750mm	350mm	
KCBC2000	2000mm	750mm	350mm	



Adjustable shelves



Thick, rounded PVC edging adding to safety & long life



KubbyClass Library furniture is a superior quality range of units that are manufactured in a solid 18mm MDF maple finish with a 2mm bump resistant PVC plastic edge with a plywood effect. Available as standard in maple with a choice of 7 colour themes. The majority of the KubbyClass Library range has adjustable shelving with hidden grooves to stop the shelves being pulled directly out. Shelves have to be lifted & then pulled forward to remove. This is a unique safety feature that adds even more to this exciting & colourful range.

As KubbyClass furniture is manufactured by one of the UK's leading manufacturers of educational furniture, it comes with a full 10 Year Guarantee as standard. KubbyClass is a truly superior range.

Choice of colours with maple



all maple or beech



Available in 6 Heights & 7 Colour Themes





KubbyClass® Slimline Bookcase

The KubbyClass Slimline Bookcase is slightly narrower at 500mm, ideal for where space is limited.

Adjustable shelving can be positioned where required & comes as standard with the KubbyClass Safety Shelf. Solid construction with 10 year guarantee.

Code	Height	Width	Depth	Price
KCSBC750	750mm	500mm	350mm	
KCSBC1000	1000mm	500mm	350mm	
KCSBC1250	1250mm	500mm	350mm	
KCSBC1500	1500mm	500mm	350mm	
KCSBC1750	1750mm	500mm	350mm	
KCSBC2000	2000mm	500mm	350mm	



KubbyClass® Library End Bookcase

These stylish units are great for completing that finished look to any library. These are suitable for all KubbyClass single-sided bookcases & are available in left & right versions. The coloured panel is on the back wall to match the bookcases.

	Code	Height	Width	Depth	Price
A - Left	KCCL750	750mm	350mm	350mm	
B - Right	KCCR750	750mm	350mm	350mm	
A - Left	KCCL1000	1000mm	350mm	350mm	
B - Right	KCCR1000	1000mm	350mm	350mm	
A - Left	KCCL1250	1250mm	350mm	350mm	
B - Right	KCCR1250	1250mm	350mm	350mm	
A - Left	KCCL1500	1500mm	350mm	350mm	
B - Right	KCCR1500	1500mm	350mm	350mm	
A - Left	KCCL1750	1750mm	350mm	350mm	
B - Right	KCCR1750	1750mm	350mm	350mm	
A - Left	KCCL2000	2000mm	350mm	350mm	
B - Right	KCCR2000	2000mm	350mm	350mm	



KubbyClass® Double - Sided Library Bookcase

High capacity, double sided bookcases. Both sides have fully adjustable safety shelving. Great for creating a divider in the library. Twice the capacity of our single sided units but not twice the price.

Used in conjunction with D-end cap bookcases, Kubby-Class library arch & the library blanking units.

Code	Height	Width	Depth	Price
KCDBC750	750mm	750mm	676mm	
KCDBC1000	1000mm	750mm	676mm	
KCDBC1250	1250mm	750mm	676mm	
KCDBC1500	1500mm	750mm	676mm	
KCDBC1750	1750mm	750mm	676mm	
KCDBC2000	2000mm	750mm	676mm	



Adjustable shelves

Fixed shelves



Kubbyclass® D-End Cap Library Bookcase

These units are used on the end of the KubbyClass double sided bookcases & on the end of the reading arch. They are an attractive & solidly built unit with curved fixed shelves.

They also make a great freestanding feature unit on any wall.

Available in all 6 heights & 7 colour themes.

Code	Height	Width	Depth	Price
KCDE750	750mm	676mm	350mm	
KCDE1000	1000mm	676mm	350mm	
KCDE1250	1250mm	676mm	350mm	
KCDE1500	1500mm	676mm	350mm	
KCDE1750	1750mm	676mm	350mm	
KCDE2000	2000mm	676mm	350mm	

Kubbyclass® Internal Corner Library Bookcase

KubbyClass Internal Corner Bookcases are brilliant for overcoming any empty spaces in your library. Now you can make a seamless run of bookcases that go around corners & maximise space.

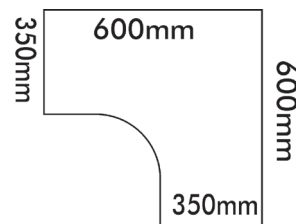

An attractive unit, recommended for every library. Used in conjunction with the single-sided library bookcases. Available in 6 heights & 7 colour themes. Solidly constructed with a 10 year guarantee.

Adjustable shelves



Code	Height	Width	Depth	Price
KCCO750	750mm	600mm	600mm	
KCCO1000	1000mm	600mm	600mm	
KCCO1250	1250mm	600mm	600mm	
KCCO1500	1500mm	600mm	600mm	
KCCO1750	1750mm	600mm	600mm	
KCCO2000	2000mm	600mm	600mm	



Kubbyclass® Blanking Unit

Blanking units for adding into spaces to create an aisle of bookcases coming away from a straight line of units - see illustration.

Available in a choice of 7 colour themes.

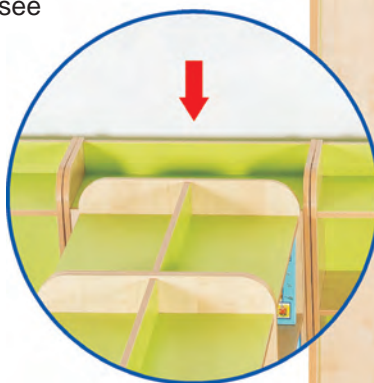
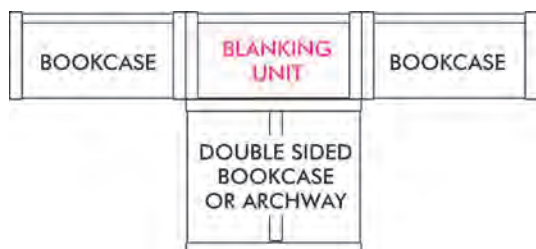

Code	Height	Width	Depth	Price
KCBL750	750mm	750mm	350mm	
KCBL1000	1000mm	750mm	350mm	
KCBL1250	1250mm	750mm	350mm	
KCBL1500	1500mm	750mm	350mm	
KCBL1750	1750mm	750mm	350mm	
KCBL2000	2000mm	750mm	350mm	



Kubbyclass® Library Archway

This great archway creates a gateway to learning zones & encourages children to explore. The archway adds interest & fun to any library. Solid construction in a choice of colours & guaranteed for 10 years.



Library Open Archway

Code	Height	Width	Depth	Price
KCLA1500	1500mm	1000mm	676mm	£469.00

Kubbyclass® Library Reading Nook

The KubbyClass Reading Nook is used with the single-sided bookcases & creates an interesting & fun feature for your library. Children & teachers simply love it! We also offer seat pads in a choice of 5 stock colours - other colours are also available, ask for details.



Choice of seat colours!

Library Reading Nook

Code	Height	Width	Depth	Price
KCRN1500	1500mm	1000mm	676mm	

Upholstered Pads - please choose colour

Item	Code	Width	Depth	Price
Seat	KCCU3	960mm	400mm	
Back	KCCU4	960mm	400mm	

Choice of seat pad colours

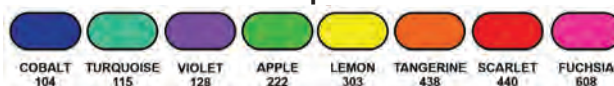

Kubbyclass® Library Seat

Ideally used with a run of single-sided bookcases. Creates a seating area along a wall & is the same depth as our single-sided library bookcases.

Solidly constructed, available in 7 colours & guaranteed for 10 years. We also offer quality seat pads in a choice of 5 colours - other colours available, call for details.



Library Seat

Code	Height	Width	Depth	Price
KCLS1500	1500mm	1000mm	350mm	

Upholstered Pads - please choose colour

Item	Code	Width	Depth	Price
Seat	KCCU1	960mm	326mm	
Back	KCCU2	960mm	326mm	

Choice of seat pad colours

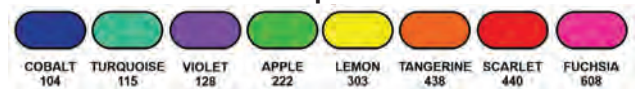

Choice of colours with maple ————— all maple or beech



Kubbyclass® Curved Library Bookcase

These units really are a superb range of quality furniture. Supplied on high quality smooth running dual wheeled castors. Four of the wheels have locks on to secure your unit if needed.

All have adjustable shelving to position where required & have the KubbyClass trademark safety shelf. Available in 4 heights & 7 colour themes. You can mix & match the heights or keep the same to create curves or circles adding real interest to your library area. Ideal for creating separate zones.



1500mm High Curved Bookcase

Code	Width	Depth	Price
KCMO1500	1825mm	676mm	



750mm High Curved Bookcase
(Double sided & fully mobile)

1000mm High Curved Bookcase
(Double sided & fully mobile)

1250mm High Curved Bookcase
(Double sided & fully mobile)



750mm High Curved Bookcases

Code	Width	Depth	Price
KCMO750	1825mm	676mm	

1000mm High Curved Bookcases

Code	Width	Depth	Price
KCMO1000	1825mm	676mm	

1250mm High Curved Bookcases

Code	Width	Depth	Price
KCMO1250	1825mm	676mm	



KubbyClass® Junior Curved Library Bookcases



750mm High Junior Curved Bookcase

Code	Height	Width	Depth	Price
KCMOJR750	750mm	1200mm	676mm	



1000mm High Junior Curved Bookcase

Code	Height	Width	Depth	Price
KCMOJR1000	1000mm	1200mm	676mm	



1250mm High Junior Curved Bookcase

Code	Height	Width	Depth	Price
KCMOJR1250	1250mm	1200mm	676mm	

Choice of wood colours

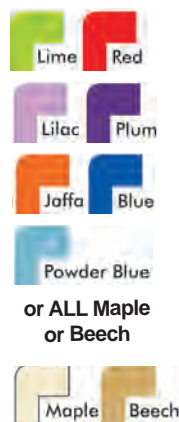

or ALL Maple or Beech



1500mm High Junior Curved Bookcase

Code	Height	Width	Depth	Price
KCMOJR1500	1500mm	1200mm	676mm	

KubbyClass® Curved Library Island - Set R



Choice of vinyl seat colours

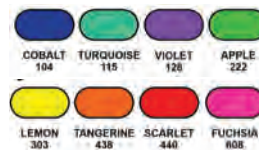

Curved Library Island (three units) with Seat

Code	Total Height	Diameter	Seat Height	Seat Dia.	Price
KCSETR	1250mm	3000mm	400mm	1100mm	

Set includes:
 3 x 1250mm High Curved Bookcases
 1 x Acorn Foam Hexagon Seat

KubbyClass® Double Bookcase Library Island - Set S



Set includes:
 3 x 1500mm High Double Bookcases
 1 x Acorn Foam Hexagon Seat

Choice of vinyl seat colours

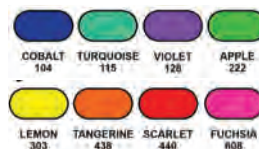

Double Bookcase Library Island (three units) with Seat

Code	Total Height	Diameter	Seat Height	Seat Dia.	Price
KCSETS	1500mm	2500mm	400mm	1100mm	

Choice of colours with maple ————— **all maple or beech**

KubbyClass® Book Browsing Centre - Set N

Set includes:
 3 x Book Browsers
 2 x Pull Out Kinderbox Drawers
 2 x Acorn Soft Foam Dot Seat

Choice of vinyl seat colours



Book Browsing Centre (five units) with two Dot Seats

Code	Height	Width	Depth	Seat Height	Seat Dia.	Price
KCSETN	750mm	2250mm	500mm	250mm	350mm	

Choice of colours with maple ————— **all maple or beech**



Open Top Book Store



Code	Height	Width	Depth	Price
KC61102	720mm	750mm	500mm	

Low Double Book Browser



Code	Height	Width	Depth	Price
KCBB1	420mm	750mm	500mm	

Low Single Book Browser



Code	Height	Width	Depth	Price
KCBB2	420mm	400mm	500mm	

Tall Single Book Browser



Code	Height	Width	Depth	Price
KCBB4	720mm	400mm	500mm	

Tall Double Book Browser



Code	Height	Width	Depth	Price
KCBB3	720mm	750mm	500mm	





Kubbyclass® Hideaway Double Nook - Set J

Set Includes:

- 1 x KubbyClass Hideaway Double Nook
- 2 x KubbyClass End Cap Bookcase
- 1 x Hideaway Double Floor Mat

KubbyClass Hideaway Double Nook Set J		
KCSETJ	H1250mm x W2100mm x D676mm	



Choice of wood colours



or ALL Maple
or Beech

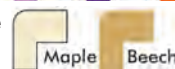

Choice of seat pad colours



Kubbyclass® Hideaway Play Nook - Set L

Set Includes:

- 1 x KubbyClass Hideaway Nook
- 2 x KubbyClass End Cap Bookcase
- 1 x Hideaway Nook Floor Mat

KubbyClass Hideaway Play Nook Set L		
KCSETL	H1250mm x W1700mm x D676mm	





Kubbyclass® Reading Nook Set E

Set Includes:

- 1 x KubbyClass Reading Nook
- 1 x Acorn Seat Pad
- 1 x Acorn Back Pad
- 2 x KubbyClass slimline Bookcases
- 1 x KubbyClass Left Hand End Bookcase
- 1 x KubbyClass Right Hand End Bookcase

KubbyClass Reading Nook Set E		
KCSETE	H1500mm x W2700mm x D676mm	

Choice of wood colours



Choice of seat pad colours



KubbyClass® Reading Corner Set P

Set Includes:

- 2 x KubbyClass 1500mm Bookcases
- 1 x KubbyClass 1500mm Left Hand End Cap Bookcase
- 1 x KubbyClass 1500mm Right Hand End Cap Bookcase
- 1 x KubbyClass 1500mm Corner Bookcase
- 1 x Acorn Dot Seat 350mm High
- 2 x Acorn Petal Seat 350mm High

KubbyClass Reading Corner	
KCSETP	H1500mm x W1700mm x D1700mm

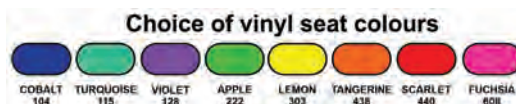

KubbyClass® Reading Corner Set C

Set Includes:

- 2 x KubbyClass 1500mm Bookcases
- 1 x KubbyClass 1500mm Left Hand End Cap Bookcase
- 1 x KubbyClass 1500mm Right Hand End Cap Bookcase
- 1 x Corner Infill Unit
- 1 x Acorn Dot Seat 350mm High
- 2 x Acorn Petal Seat 350mm High

KubbyClass Instant Reading Corner Set C	
KCSETC	H1500mm x W1465mm x D1465mm

Acorn Island Tree Seat

Set Includes:

- A comfortable circular seat for reading & work groups Upholstered in anti-microbial, wipe clean vinyl in a choice of colour combinations.
- A hand crafted artificial tree, bringing the outside, inside.
- A vibrant centre piece with a colour choice of Cobalt/Apple, Scarlet/Cobalt or Apple/Violet.



Each tree is individually hand made so may vary slightly from image shown.



Acorn Island Seat		
D81203	H1800mm x W1000mm	Seat Height 400mm



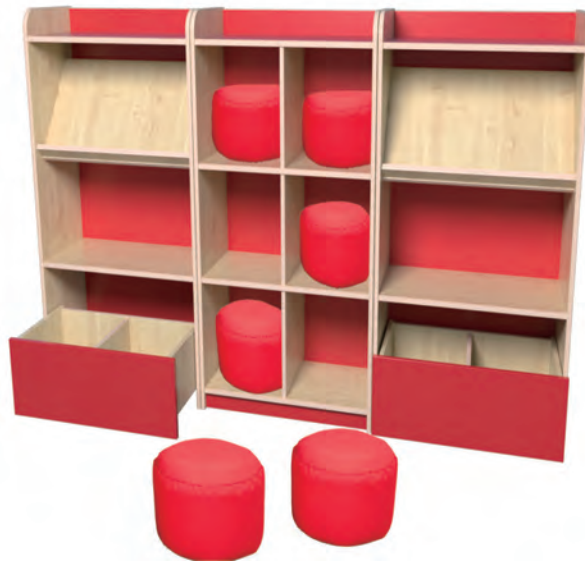

KubbyClass® Display & Browse Set M

Set Includes:

- 2 x KubbyClass Display & Browse Bookcases
- 1 x KubbyClass KubbyHole Bookcase
- 6 x Acorn Bean Pod Seats

KubbyClass Display & Browse Set M		
KCSETM	H1250mm x W2250mm x D350mm	

Choice of seat colours



Choice of wood colours



KubbyClass® Display & Browse Set G

KubbyClass Display & Browse Reading Set G		
KCSETG	H1250mm x W2250mm x D350mm	



KubbyClass® Book Tree Option 1



Choice of wood colours



KubbyClass® Book Tree Option 2



Each tree is must be secured against a wall - fixings not supplied.

KubbyClass Book Tree Option 1		
KCBTOP1	H1500mm x W900mm x D320mm	

KubbyClass Book Tree Option 2		
KCBTOP2	H1500mm x W900mm x D320mm	

KubbyClass® Reading Bench Set K

- Set Includes:**
 2 x KubbyClass 750mm Bookcases
 1 x KubbyClass Reading Bench
 1 x Bench Seat Pad
 3 x Acorn Cube Soft Seats



KubbyClass Instant Reading Corner Set C	
KCSETK	H750mm x W2734mm x D350mm



KubbyClass® Instant Library Wall Set B

- Set Includes:**
 1 x KubbyClass 1500mm Bookcases
 1 x KubbyClass 1500mm Left Hand End Cap Bookcase
 1 x KubbyClass Right Hand End Cap Bookcase

KubbyClass Instant Reading Corner Set B	
KCSETB	H1500mm x W1450mm x D350mm

Acorn Mini Dot Soft Foam Seats



Acorn Mini Dot Soft Foam Seat - Single Seat	
D81013	350mm High x 350mm Dia.

Set of Four	
D81086	

Acorn Cube Foam Seats



Acorn Cube Foam Seat - Single Seat	
D81093	H350mm x W350mm x D350mm

Set of Four	
D81063	

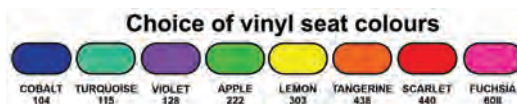

KubbyClass® Junior Curved Bookcase & Seat Set H

Set Includes:

- 1 x 750H KCMOIJR750
- 1 x 1000H KCMOIJR1000
- 1 x 1250H KCMOIJR1250
- 1 x 1500H KCMOIJR1500
- 4 x Curved Soft Seats 320mm Dia.



KubbyClass Junior Curved Bookcase & Seat Set H	
KCSETH	1500mm High x 3200mm Dia.

Choice of vinyl seat colours



Choice of colours with maple



all maple or beech

KubbyClass® Junior Curved Bookcase Set Q

Set Includes:

- 1 x 750H KCMOIJR750
- 1 x 1000H KCMOIJR1000
- 1 x 1250H KCMOIJR1250
- 1 x 1500H KCMOIJR1500

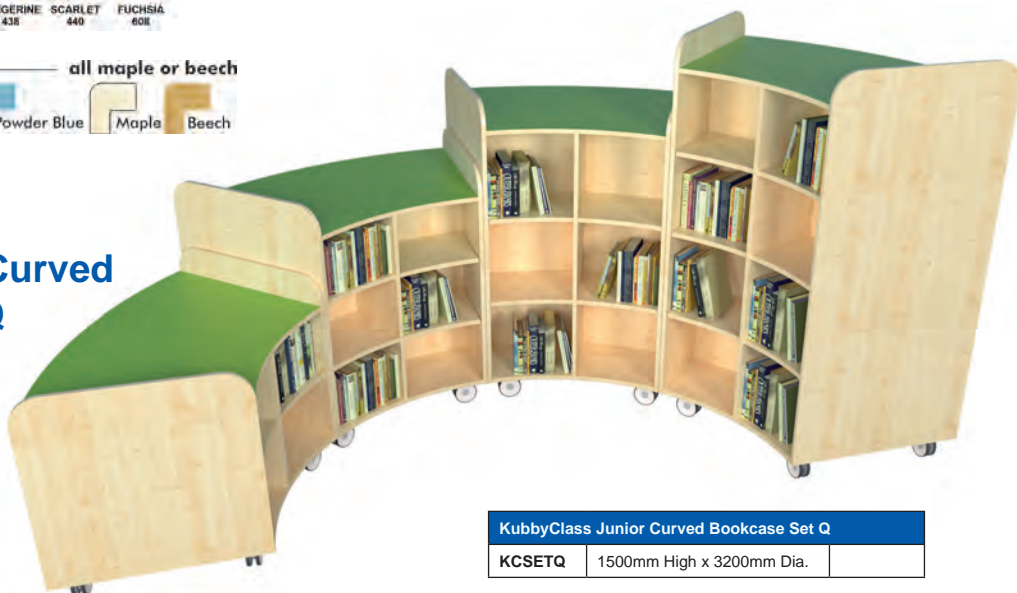

KubbyClass Junior Curved Bookcase Set Q	
KCSETQ	1500mm High x 3200mm Dia.

Acorn Bean Cube Seats



Acorn Bean Cube Seat - Set of Four	
D81111	H380mm x W380mm x D380mm

Set of Six	
D81112	

Acorn Bean Pod Seats



Acorn Bean Pod Seats - Set of Four	
D81105	200mm High x 400mm Dia.

Set of Six	
D81106	

Choice of bean bag fabric colours



Kubbyclass® Book Staircase

Four rounded shelves each side are ideal for displaying book titles, magazines & literature. Mounted on quality lockable castors..

The KubbyClass Library Book Staircase is manufactured in a solid 18mm MDF maple laminate, with 2mm ply effect edging.

Available in seven colour themes, Red, Blue, Lime, Lilac, Plum, Jaffa or Powder Blue. Also in a Maple or Beech finish throughout.

Solid construction in a choice of 7 colour themes & guaranteed for 10 years.



Library Book Staircases

Code	Height	Width	Depth	Price
KCSTAIR	1200mm	650mm	550mm	

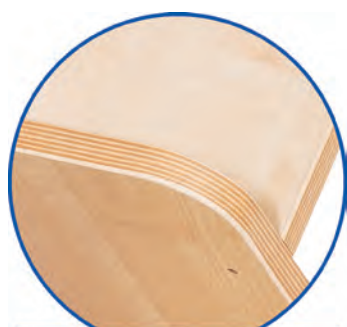

Bump resistant edges



Quality locking castors



Book Carousels

These stylish & attractive units are really versatile, with a variety of uses ranging from file to book storage & great for creating displays.

The KubbyClass Library Book Carousels are manufactured in a solid 18mm MDF Maple laminate with 2mm ply effect, bump resistant edging.

Available in seven colour themes, Lime, Red, Jaffa, Lilac, Plum, Blue, Powder Blue. Can also be supplied in a Maple or Beech throughout.



Bump resistant edges



Quality locking castors



Versatile storage or display

Book Carousel - 1 Tier



KubbyClass Book Carousel 1 Tier

Code	Height	Dia.	Price
KCCAR1	430mm	650mm	

Book Carousel - 2 Tier



KubbyClass Book Carousel 2 Tier

Code	Height	Dia.	Price
KCCAR2	770mm	650mm	

Book Carousel - 3 Tier



KubbyClass Book Carousel 3 Tier

Code	Height	Dia.	Price
KCCAR3	1105mm	650mm	

Book Carousel - 4 Tier



KubbyClass Book Carousel 4 Tier

Code	Height	Dia.	Price
KCCAR4	1445mm	650mm	



Kubbyclass® Polar White Library

KubbyClass Polar White furniture is a superior quality range of units that are manufactured in a solid 18mm MDF white outer finish that are available in a choice of 7 colour themes. All units have a durable, 2mm bump resistant, PVC, plywood effect edge. All bookcases have adjustable shelving with hidden grooves to stop the shelves being pulled directly out.

Shelves have to be lifted and then pulled forward to remove. This is a unique, KubbyClass safety feature that adds even more to this exciting, colourful range. Besides the 7 colours in the range, KubbyClass Polar can be supplied in an all white finish throughout.

The range consists of standard size, slimline & double sided bookcases, plus end-cap & D-end units that finish the look off.

Available in 6 heights ranging from 750mm high to 2 metres tall. All units are delivered fully assembled & ready to use, backed up by a 10 year guarantee, an industry first!



CHOICE OF COLOUR THEMES



Lime

Jaffa

Red

Plum

Lilac

Blue

Powder Blue



Kubbyclass® Polar Slimline Bookcase



Adjustable shelves

Kubbyclass® Polar Library Bookcase

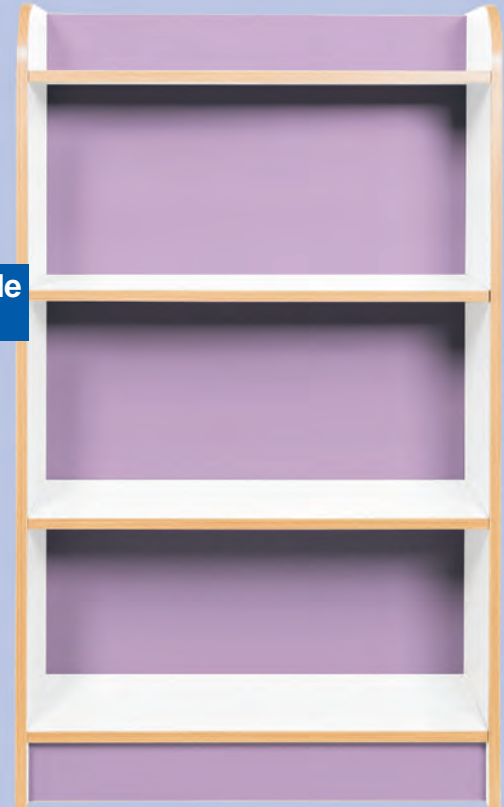

Adjustable shelves

All units are available in a white laminate with **CHOICE OF COLOUR THEMES**

- Lime
- Red
- Lilac
- Plum
- Jaffa
- Blue
- Powder Blue

Code	Height	Width	Depth	Price
KCWSBC750	750mm	500mm	350mm	
KCWSBC1000	1000mm	500mm	350mm	
KCWSBC1250	1250mm	500mm	350mm	
KCWSBC1500	1500mm	500mm	350mm	
KCWSBC1750	1750mm	500mm	350mm	
KCWSBC2000	2000mm	500mm	350mm	

Code	Height	Width	Depth	Price
KCWBC750	750mm	750mm	350mm	
KCWBC1000	1000mm	750mm	350mm	
KCWBC1250	1250mm	750mm	350mm	
KCWBC1500	1500mm	750mm	350mm	
KCWBC1750	1750mm	750mm	350mm	
KCWBC2000	2000mm	750mm	350mm	



Adjustable shelves

Kubbyclass® Polar Library Double Sided Bookcase

These really are a high capacity bookcase. Both sides have fully adjustable safety shelving. Great for creating a divider in the library. Twice the capacity of our single sided units but certainly not twice the price.

Used in conjunction with D-end cap bookcases, KubbyClass library arch & single blanking units.

Code	Height	Width	Depth	Price
KCWDBC750	750mm	750mm	676mm	
KCWDBC1000	1000mm	750mm	676mm	
KCWDBC1250	1250mm	750mm	676mm	
KCWDBC1500	1500mm	750mm	676mm	
KCWDBC1750	1750mm	750mm	676mm	
KCWDBC2000	2000mm	750mm	676mm	

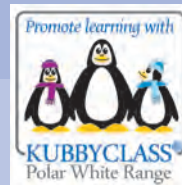

Kubbyclass® Polar End Bookcase - Left

These stylish end units are great for completing that finished look to any library. These are suitable for all of the KubbyClass single sided bookcases & are available in left & right versions. The coloured panel is on the back wall to match the bookcases.

Fixed shelves

All units are available in a white laminate with

CHOICE OF COLOUR THEMES

- Lime
- Red
- Lilac
- Plum
- Jaffa
- Blue
- Powder Blue

Code	Height	Width	Depth	Price
KCWCL750	750mm	350mm	350mm	
KCWCL1000	1000mm	350mm	350mm	
KCWCL1250	1250mm	350mm	350mm	
KCWCL1500	1500mm	350mm	350mm	
KCWCL1750	1750mm	350mm	350mm	
KCWCL2000	2000mm	350mm	350mm	

Kubbyclass® Polar End Bookcase - Right

Fixed shelves

All units are available in a white laminate with

CHOICE OF COLOUR THEMES

- Lime
- Red
- Lilac
- Plum
- Jaffa
- Blue
- Powder Blue

Code	Height	Width	Depth	Price
KCWCR750	750mm	350mm	350mm	
KCWCR1000	1000mm	350mm	350mm	
KCWCR1250	1250mm	350mm	350mm	
KCWCR1500	1500mm	350mm	350mm	
KCWCR1750	1750mm	350mm	350mm	
KCWCR2000	2000mm	350mm	350mm	

Kubbyclass® Polar Library D-Cap Bookcase

These units are used on the end of the KubbyClass double sided bookcases & on the end of the reading arch. They are an attractive & solidly built unit with curved fixed shelves.

They also make a great freestanding feature unit on any wall. Available in all 6 heights & 7 colour themes.

Fixed shelves



Code	Height	Width	Depth	Price
KCWDE750	750mm	676mm	350mm	
KCWDE1000	1000mm	676mm	350mm	
KCWDE1250	1250mm	676mm	350mm	
KCWDE1500	1500mm	676mm	350mm	
KCWDE1750	1750mm	676mm	350mm	
KCWDE2000	2000mm	676mm	350mm	



Kubbyclass® Polar Library Internal Corner Bookcases

KubbyClass Internal Corner Bookcases are brilliant for overcoming any empty spaces in your library. Now you can make a seamless run of bookcases that go around corners & maximise space. An attractive unit, recommended for every library. Used in conjunction with the single sided library bookcases. Available in 6 heights & 7 colour themes.

Adjustable shelves



All units are available in a white laminate with **CHOICE OF COLOUR THEMES**

- Lime
- Red
- Lilac
- Plum
- Jaffa
- Blue
- Powder Blue

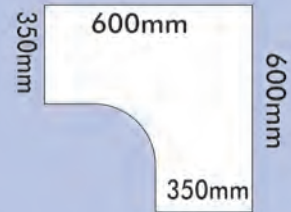

CODE	HEIGHT	WIDTH	DEPTH	PRICE
KCWCO750	750mm	600mm	600mm	
KCWCO1000	1000mm	600mm	600mm	
KCWCO1250	1250mm	600mm	600mm	
KCWCO1500	1500mm	600mm	600mm	
KCWCO1750	1750mm	600mm	600mm	
KCWCO2000	2000mm	600mm	600mm	

CHOICE OF COLOUR THEMES



Kubbyclass® Polar Library Blanking Unit

Blanking units for adding into spaces when you wish to create an aisle of bookcases coming away from a straight line of units - see illustration. Available in 6 heights & a choice of 7 colour themes.

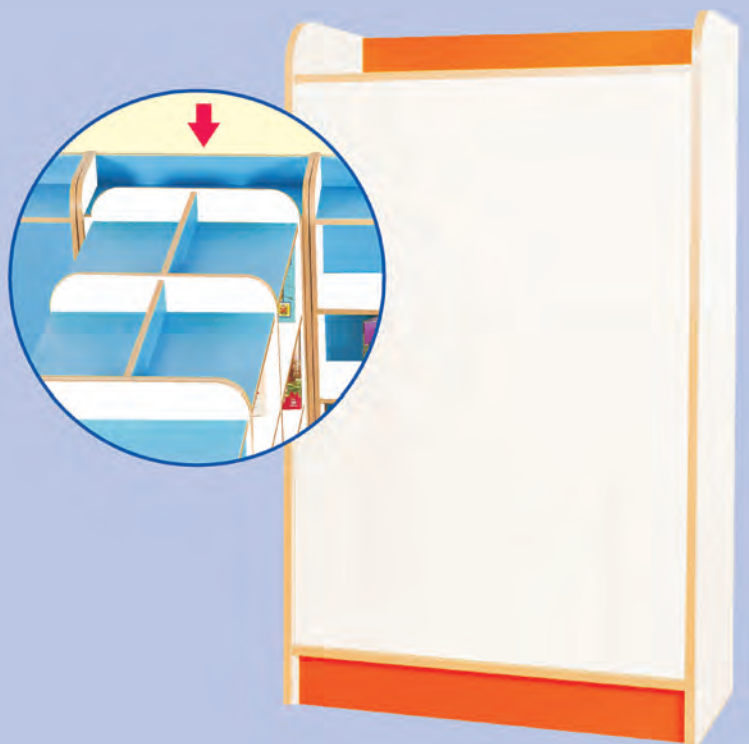
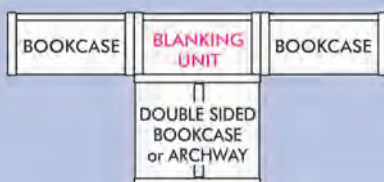

Code	Height	Width	Depth	Price
KCWBL750	750mm	750mm	350mm	
KCWBL1000	1000mm	750mm	350mm	
KCWBL1250	1250mm	750mm	350mm	
KCWBL1500	1500mm	750mm	350mm	
KCWBL1750	1750mm	750mm	350mm	
KCWBL2000	2000mm	750mm	350mm	



Kubbyclass® Polar Library Archway

Not only creates gateways to other learning zones, these open arches encourage children to explore specific learning areas whilst adding fun to any library. Solidly constructed in 18mm thick, high quality MDF with a 2mm bump resistant, PVC, rounded ply edge effect. Available with a choice of 7 colour themes. Height 1500mm x Width 1000mm x Depth 676mm

Code	Height	Width	Depth	Price
KCWLA1500	1500mm	1000mm	676mm	



Lime Jaffa Red Plum Lilac Blue Powder Blue

Kubbyclass® Polar Library Seat

Ideally used with a run of single sided bookcases. Creates a seating area along a wall & is the same depth as the single sided bookcases. High quality, upholstered seat pads available separately.

Code	Height	Price
KCWLS1500	1500mm	

Code	Width	Height	Description	Price
KCCU2	960mm	326mm	Back Pad	
KCCU1	960mm	326mm	Seat Pad	



Choice of seat pad colours





Kubbyclass® Polar Reading Nook

The KubbyClass Reading Nook is used with the single sided bookcases & creates an interesting & fun feature for your library. Children & teachers love it!



Code	Height	Width	Depth	Price
KCWRN1500	1500mm	1000mm	676mm	

Code	Width	Depth	Description	Price
KCCU4	960mm	400mm	Back Pad	
KCCU3	960mm	400mm	Seat Pad	

Choice of seat pad colours

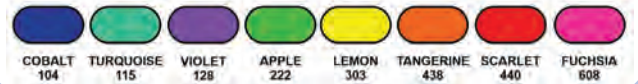

Lime



Jaffa



Red



Plum



Lilac



Blue



Powder Blue





Kubbyclass® Polar Library Curved Mobile Bookcases

These double sided units really are a superb range of quality furniture. Supplied on high quality smooth running wheeled castors. Four of the wheels have locks on to secure your unit if needed.

All have adjustable shelving to position where required & have the KubbyClass trademark safety shelf. Available in 4 heights & the usual 7 colour themes. You can mix & match the heights or keep to the same to create curves or circles. Often libraries will have 3 or 4 of these to create a semi-circle where a separate zone is required.

Width 1825mm x Depth 676mm

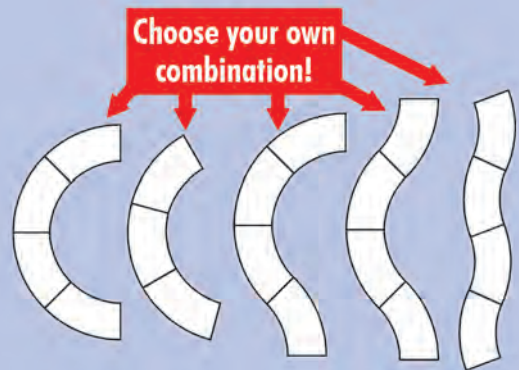

Code	Height	Price
KCWMO1500	1500mm	



Lime

Jaffa

Red

Plum

Lilac

Blue

Powder Blue

H750mm Curved Bookcase Double Sided



Code	Height	Price
KCWMO750	750mm	

H1000mm Curved Bookcase Double Sided



Code	Height	Price
KCWMO1000	1000mm	

H1250mm Curved Bookcase Double Sided



Code	Height	Price
KCWMO1250	1250mm	



Single Low Book Browser

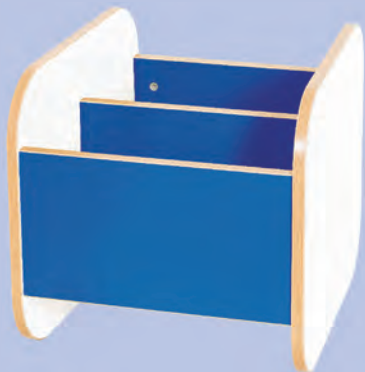

Code	Height	Width	Depth	Price
KCWBB2	420mm	400mm	500mm	

Double Low Book Browser



Code	Height	Width	Depth	Price
KCWBB1	420mm	750mm	500mm	

Single Tall Book Browser



Code	Height	Width	Depth	Price
KCWBB4	420mm	400mm	500mm	

Double Tall Book Browser



Code	Height	Width	Depth	Price
KCWBB3	720mm	750mm	500mm	



Kubbyclass® Tray Units

KubbyClass Tray Units are a superior quality range of furniture that is manufactured in a solid 18mm MDF Maple finish & available in 7 colour themes. They have a 2mm, bump resistant, PVC plywood effect edge. All Tray Units have easy glide runners so the trays slide in and out smoothly.

Solidly constructed with a 10 year guarantee. All Gratrrells colour trays are available in a choice of colours & in 4 depths.

All heights of tray units match the KubbyClass Cupboard range.

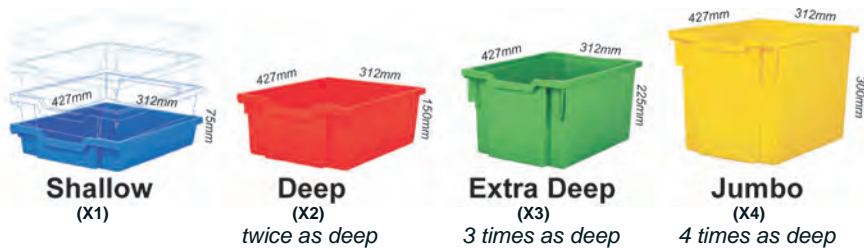

Choice of colours with maple ————— all maple or beech



Kubbyclass® Single Column Tray Units

Available in 5 heights that match all cupboards.
 Width 362mm x Depth 462mm.



6 Tray Unit

Code	Price
KCTS6	



7 Tray Unit

Code	Price
KCTS7	



8 Tray Unit

Code	Price
KCTS8	



9 Tray Unit

Code	Price
KCTS9	



10 Tray Unit

Code	Price
KCTS10	

Wood
 Colour
 Choice



Lime



Red



Lilac



Plum



Jaffa



Blue



Powder
 Blue



ALL
 Beech



ALL
 Maple

Kubbyclass® Single Column Combination Tray Units

Available in 5 heights that match all cupboards.
 Width 362mm x Depth 462mm.



3 x X2 Trays

Code	Price
KCTSC1	



1 x X3 - X4 Trays

Code	Price
KCTSC2	



4 x X2 Trays

Code	Price
KCTSC3	



3 x X3 Trays

Code	Price
KCTSC4	



5 x X2 Trays

Code	Price
KCTSC5	

Kubbyclass® Single Column Combination Tray Units

Available in 5 heightsWidth 362mm x Depth 462mm.



2x X3 Trays

Code	Price
KCTSC6	



2 x X3 - 1 x Std

Code	Price
KCTSC7	



2 x X4 Trays

Code	Price
KCTSC8	



1 x X2, X3, X4

Code	Price
KCTSC9	



1 x Std, X2, X3, X4

Code	Price
KCTSC10	

Kubbyclass® Double Column Tray Units

Available in 5 heights that match all cupboards.
 Width 706mm x Depth 462mm.



707mm High

792mm High

12 Tray Double

14 Tray Double

Code	Price
------	-------

Code	Price
------	-------

KCTD12

KCTD14

Wood Colour Choice



Lime



Red



Lilac



Plum



Jaffa



Blue



Powder Blue



ALL Beech



ALL Maple

Kubbyclass® Double Column Combination Tray Units

Available in 5 heights that match all cupboards.
 Width 706mm x Depth 462mm.



707mm High



792mm High



877mm High

6 x X2 Trays

2 x X3, X4 Trays

8 x X2 Trays

Code	Price
------	-------

Code	Price
------	-------

Code	Price
------	-------

KCTDC1

KCTDC2

KCTDC3

Kubbyclass® Double Column Combination Units

Available in 5 heights that match all cupboards.
 Width 706mm x Depth 462mm.



707mm High



792mm High



4 x X3 Trays

2 x Std, 4 x X3 Trays

Code	Price
------	-------

Code	Price
------	-------

KCTDC6

KCTDC7



16 Tray Double

Code	Price
------	-------

KCTD16



18 Tray Double

Code	Price
------	-------

KCTD18



20 Tray Double

Code	Price
------	-------

KCTD20



6 x X3 Trays

Code	Price
------	-------

KCTDC4



10 x X2 Trays

Code	Price
------	-------

KCTDC5



Wood Colour Choice



Lime



Red



Lilac



Plum



Jaffa



Blue



Powder Blue



ALL Beech



ALL Maple



4 x X4 Trays

Code	Price
------	-------

KCTDC8



2 x X2,X3,X4 Trays

Code	Price
------	-------

KCTDC9



2 x Std,X2,X3,X4 Trays

Code	Price
------	-------

KCTDC10

Kubbyclass® Triple Column Tray Units

Available in 5 heights that match all cupboards.
 Width 1050mm x Depth 462mm.



707mm High



792mm High



Wood Colour Choice



Lime



Red



Lilac



Plum



Jaffa



Blue



Powder Blue



ALL Beech



ALL Maple

18 Tray Triple

Code	Price
KCTT18	

21 Tray Triple

Code	Price
KCTT21	

Kubbyclass® Triple Column Combination Tray Units

Available in 5 heights that match all cupboards.
 Width 1050mm x Depth 462mm.

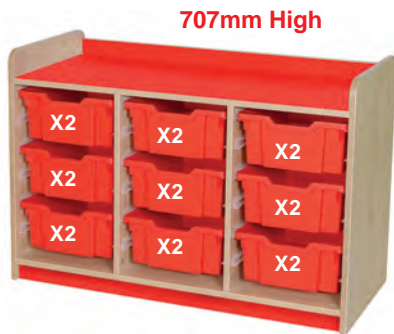

707mm High

9 x X2 Trays

Code	Price
KCTTC1	



792mm High

3 x X3,X4 Trays

Code	Price
KCTTC2	



877mm High

12 x X2 Trays

Code	Price
KCTTC3	

Kubbyclass® Triple Column Combination Units

Available in 5 heights that match all cupboards.
 Width 1050mm x Depth 462mm.



707mm High

6 x X3 Trays

Code	Price
KCTTC6	



792mm High

3 x Std, 6 x X3 Trays

Code	Price
KCTTC7	





24 Tray Triple

Code	Price
KCTT24	



27 Tray Triple

Code	Price
KCTT27	



30 Tray Triple

Code	Price
KCTT30	

Wood Colour Choice



Lime



Red



Lilac



Plum



Jaffa



Blue



Powder Blue



ALL Beech



ALL Maple



9 x X3 Trays

Code	Price
KCTTC4	



15 x X2 Trays

Code	Price
KCTTC5	



6 x X4 Trays

Code	Price
KCTTC8	

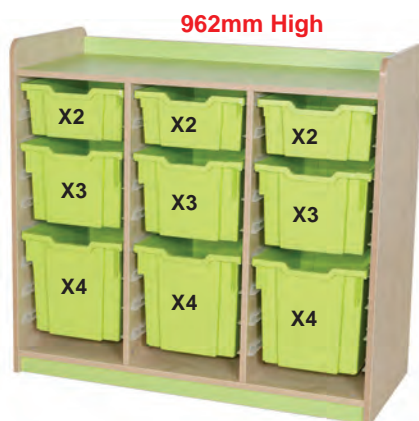

3 x X2,X3,X4 Trays

Code	Price
KCTTC9	



3 x Std,X2,X3,X4 Trays

Code	Price
KCTTC10	

Kubbyclass® Quad Column Tray Units

Available in 5 heights that match all cupboards.
 Width 1394mm x Depth 462mm.



707mm High



792mm High



24 Tray Quad

Code	Price
KCTQ24	

28 Tray Quad

Code	Price
KCTQ28	

Wood Colour Choice



Lime



Red



Lilac



Plum



Jaffa



Blue



Powder Blue



ALL Beech



ALL Maple

Kubbyclass® Quad Column Combination Units

Available in 5 heights that match all cupboards.
 Width 1394mm x Depth 462mm.

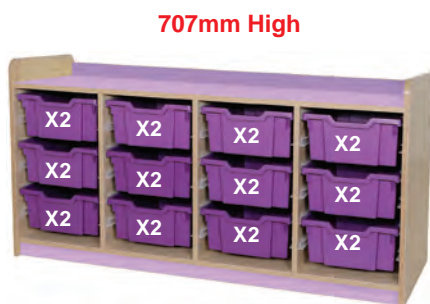

707mm High

12 x X2 Trays

Code	Price
KCTQC1	



792mm High

4 x X3, 4 x X4 Trays

Code	Price
KCTQC2	



877mm High

16 x X2 Trays

Code	Price
KCTQC3	

Kubbyclass® Quad Column Combination Tray Units

Available in 5 heights that match all cupboards.
 Width 1394mm x Depth 462mm.



707mm High

8 x X3 Trays

Code	Price
KCTQC6	

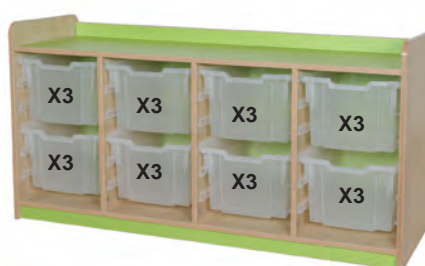

792mm High

4 x Std, 8 x X3 Trays

Code	Price
KCTQC7	

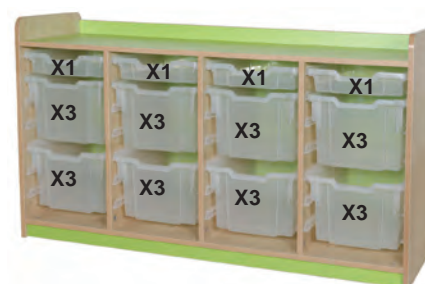

877mm High



32 Tray Quad

Code	Price
KCTQ32	

962mm High



36 Tray Quad

Code	Price
KCTQ36	

1047mm High



40 Tray Quad

Code	Price
KCTQ40	

962mm High



12 x X3 Trays

Code	Price
KCTQC4	

1047mm High



20 x X2 Trays

Code	Price
KCTQC5	



1047mm High



4 x Std, X2, X3, X4 Trays

Code	Price
KCTQC10	

877mm High

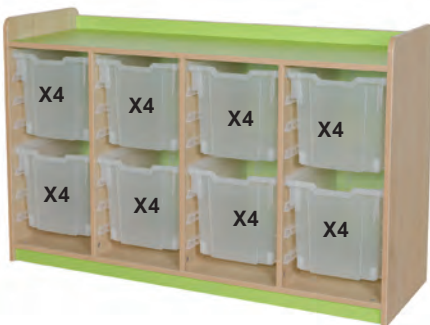

8 x X4 Trays

Code	Price
KCTQC8	

962mm High



4 x X2, X3, X4 Trays

Code	Price
KCTQC9	

Wood Colour Choice



Lime



Red



Lilac



Plum



Jaffa



Blue



Powder Blue



ALL Beech



ALL Maple

Kubbyclass® Slimline Cupboards

High quality, slimline cupboards come with hinged single door & adjustable shelves as shown. All of these cupboards have matching height tray units. Each unit also has the added 10 year guarantee.

Choice of 7 colour themes.

OPTIONAL LOCKS ADD £15

Note: All single door cupboards have hinges on the left. Please let us know if you would like the hinges fitted on the right hand side.



Wood Colour Choice



Lime



Red



Lilac



Plum



Jaffa



Blue



Powder Blue



ALL Beech



ALL Maple

H707mm Slim Cupboard

H707mm x W362mm x D480mm



Code Price
KCCUP1

H792mm Slim Cupboard

H792mm x W362mm x D480mm



Code Price
KCCUP2

H877mm Slim Cupboard

H877mm x W362mm x D480mm



Code Price
KCCUP3

962mm High Slim Cupboard

H962mm x W362mm x D480mm



Code Price
KCCUP4



1047mm High Slim Cupboard

H1047mm x W362mm x D480mm



Code Price
KCCUP5



Kubbyclass® Midi 2 Door Cupboards

Midi cupboards in the KubbyClass range make a great addition to the classroom, library or office. Durable & high quality build, together with the stylish good looks has made this range one of the most popular in UK schools & academies. Cupboards come with sturdy hinged doors & adjustable shelves and our bump resistant PVC, edging is fitted as standard. Each unit also has a 10 year guarantee.

Choice of 7 colour themes & 5 heights.



All cupboards have matching height tray units!



- Wood Colour Choice**
-  Lime
 -  Red
 -  Lilac
 -  Plum
 -  Jaffa
 -  Blue
 -  Powder Blue
 -  ALL Beech
 -  ALL Maple

Optional locks please add £20.00

Midi 2 Door Cupboards

Code	Dimensions	Price
KCCUP10	H707mm x W706mm x D480mm	
KCCUP11	H792mm x W706mm x D480mm	
KCCUP12	H877mm x W706mm x D480mm	
KCCUP13	H962mm x W706mm x D480mm	
KCCUP14	H1047mm x W706mm x D480mm	

Kubbyclass® Wide 2 Door Cupboards

High quality, 1050mm wide, two door cupboards come with adjustable shelves & quality, strong, safety hinges. All KubbyClass© furniture is made from a solid & durable, 18mm MDF laminate & has 2mm rounded PVC, bump resistant edging fitted as standard. Units are all manufactured in the UK & delivered fully assembled. These units are built to last & the entire KubbyClass© range has a 10 year guarantee. Choice of 7 colour themes & 5 heights.



Wood Colour Choice



Lime



Red



Lilac



Plum



Jaffa



Blue



Powder Blue



ALL Beech



ALL Maple

Optional locks - please add £20.00



Wide 2 Door Cupboards

Code	Dimensions	Price
KCCUP20	H707mm x W1050mm x D480mm	
KCCUP21	H792mm x W1050mm x D480mm	
KCCUP22	H877mm x W1050mm x D480mm	
KCCUP23	H962mm x W1050mm x D480mm	
KCCUP24	H1047mm x W1050mm x D480mm	

Kubbyclass® Single Column Storage Cubes

H750mm 2 Space Cube

H750mm x W500mm x D350mm.



Code Price
 KCSC1

H1000mm 2 Space Cube

H1000mm x W500mm x D350mm.



Code Price
 KCSC2

H1250mm 3 Space Cube

H1250mm x W500mm x D350mm.



Code Price
 KCSC3

H1500mm 4 Space Cube

H1500mm x W500mm x D350mm.



Code Price
 KCSC4

H1750mm 4 Space Cube

H1750mm x W500mm x D350mm.



Code Price
 KCSC5

H2000mm 5 Space Cube

H2000mm x W500mm x D350mm.



Code Price
 KCSC6

Wood Colour Choice



Kubbyclass® Double Column Storage Cubes

These units are perfect for the classroom, libraries or for general storage & are available in six heights. All KubbyClass Cube Storage units are the same heights as the KubbyClass Library Bookcases, so these units can also be integrated into library settings.

Available from stock in 7 attractive colours & guaranteed for 10 years.

Wood Colour Choice



Lime



Red



Lilac



Plum



Jaffa



Blue



Powder Blue



ALL Beech



ALL Maple

H750mm 4 Space Cube

H750mm x W750mm x D350mm.



Code **Price**
 KCSC7

H1000mm 4 Space Cube

H1000mm x W750mm x D350mm.

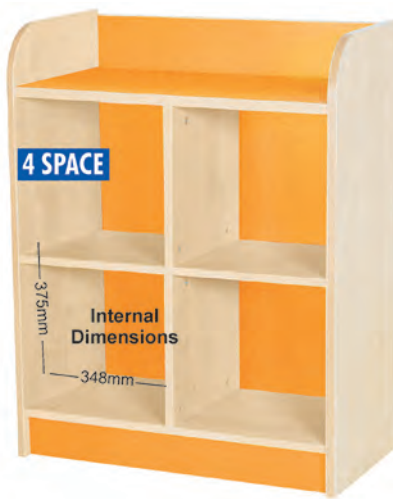

Code **Price**
 KCSC8

H1250mm 6 Space Cube

H1250mm x W750mm x D350mm.

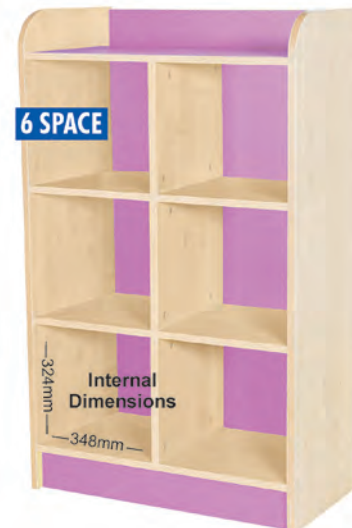

Code **Price**
 KCSC9

H1500mm 8 Space Cube

H750mm x W750mm x D350mm.



Code **Price**
 KCSC10

H1750mm 8 Space Cube

H1000mm x W750mm x D350mm.



Code **Price**
 KCSC11

H2000mm 10 Space Cube

H1250mm x W750mm x D350mm.



Code **Price**
 KCSC12

Kubbyclass® Triple Column Storage Cubes

H750mm 6 Space Cube

H750mm x W1000mm x D350mm.



Code Price

KCSC13

H1000mm 6 Space Cube

H1000mm x W1000mm x D350mm.



Code Price

KCSC14

H1250mm 9 Space Cube

H1250mm x W1000mm x D350mm.



Code Price

KCSC15

H1500mm 12 Space Cube

H1500mm x W1000mm x D350mm.



Code Price

KCSC16

H1750mm 12 Space Cube

H1750mm x W1000mm x D350mm.



Code Price

KCSC17

H2000mm 15 Space Cube

H2000mm x W1000mm x D350mm.



Code Price

KCSC18

Wood Colour Choice



Lime



Red



Lilac



Plum



Jaffa



Blue



Powder Blue



ALL Beech



ALL Maple



A large range to suit all age groups

EARLY YEARS
Pages 257-275

BEAN BAGS
Pages 276-294

PRIMARY
Pages 295-318

SECONDARY
Pages 319-340

Acorn Soft Furniture is a huge range of high quality, premium standard school furniture that is all manufactured here in the UK, using skilled craftsmen & women & superior materials. The range consists of Early Years, Primary & Secondary, which also includes a large selection of Bean Bags & reception furniture.



Kubbyclass® Teacher Station

A great unit that is now a classroom essential. Ideal to store your laptop securely between classes. Complete with a sliding shelf on metal runners & with three Gratnells trays to help keep things tidy. The KubbyClass® Laptop Tidy is manufactured in a solid MDF Maple laminate with 2mm ply effect edging.

Available in seven colour themes; Lime, Red, Jaffa, Lilac, Plum, Blue, Powder Blue - they can also be supplied in Maple or Beech finish throughout.

The units are supplied static with a plinth as standard, but can be manufactured to be mobile on castors if preferred.



Chrome Cable Tidy



Fold-Flat Safety Hinges

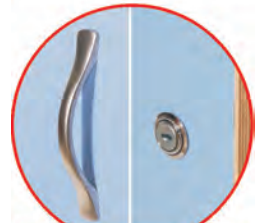

Lock & Chrome Handle



Shelf on Metal Runners



Bump resistant edges



Kubbyclass® Static Teacher Station

Code	Height	Width	Depth	Price
KCLAP1	960mm	520mm	480mm	

Kubbyclass® Mobile Teacher Station

Code	Height	Width	Depth	Price
KCLAP1MOB	960mm	520mm	480mm	

Choice of 7 colour themes - also available in Maple or Beech finish throughout





Kubbyclass® Lockers

KubbyClass Lockers are a premium class locker range mainly used for Primary School children. They are available in 1, 2 & 3 door variants. The single door version comes with a shelf & 2 indestructible coat pegs. These quality units are crafted to the highest standard set by the KubbyClass brand using the best materials & featuring a solid 18mm back panel. As with all of the KubbyClass range we offer a Ten Year Guarantee.

The hinges that we use allow the doors to open a full 270 degrees, allowing plenty of access to the locker. The metal nickel handles used on the doors are flush mounted for extra safety so that bag straps do not get caught in busy corridors.



- **18mm thick, solid construction**
- **270 degree opening hinges**
- **Solid 18mm back panels**
- **Flush inset metal handles**
- **Full 10 year guarantee**
- **The highest quality range available**

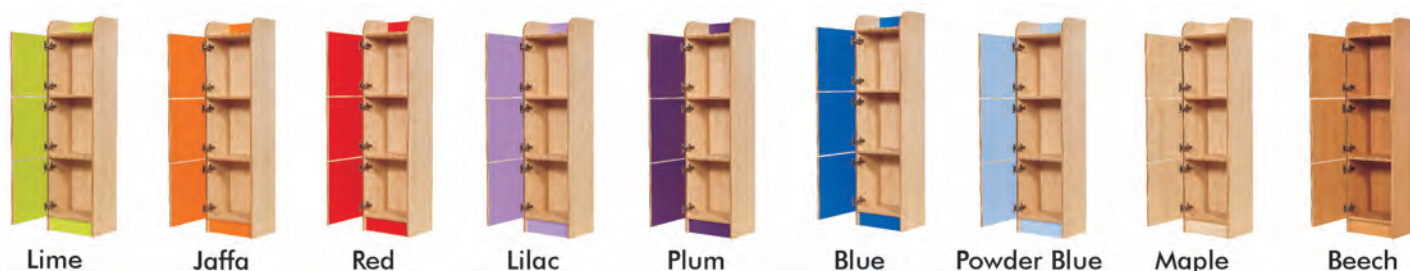

Choice of colours with maple

all maple or beech



Single Door Lockers



Two Door Lockers



Three Door Lockers

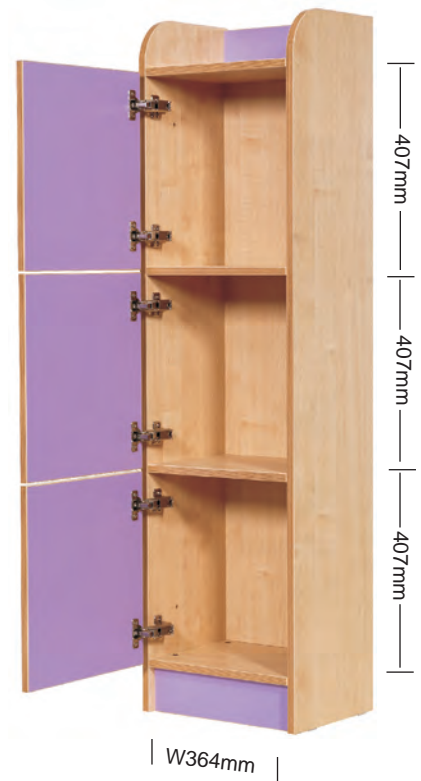

Code	Height	Width	Depth	Price
KCLOCK1	1500mm	400mm	320mm	

Code	Height	Width	Depth	Price
KCLOCK2	1500mm	400mm	320mm	

Code	Height	Width	Depth	Price
KCLOCK3	1500mm	400mm	320mm	



Kubbyclass® Coat Tidys

KubbyClass Coat Tidys are solidly built to last, constructed with metal legs & frames, solid seats & rails & use coatpegs that have a lifetime guarantee.

All KubbyClass® Coat Tidys are supplied with fitted storage shelf for shoes & bags.

Each Tidy is supplied with two floor tubes that we recommend are used to secure the units to the floor.

Available in 3 heights & 11 different widths, plus a corner version. Each tidy has a choice of colour themes & coat peg colours.



Units are constructed in Maple with a choice of contrasting colour theme

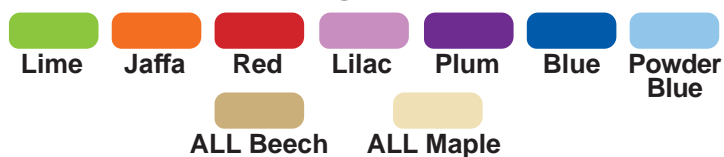

Choose Width > Choose Height (age group) > Choose Wood Colour > Choose Peg Colour

UNBREAKABLE COATHOOKS
in a choice of colours!

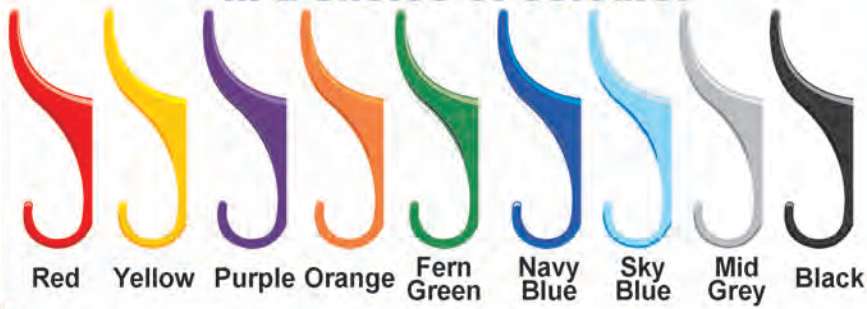

CHOICE OF 11 WIDTHS

600mm - 1600mm
(6 pegs to 16 pegs 100mm increments)

CHOICE OF 3 HEIGHTS

1700mm (11 to Adult) Seat H460mm
1400mm (8-11) Seat H380mm
1100mm (6-8) Seat H350mm

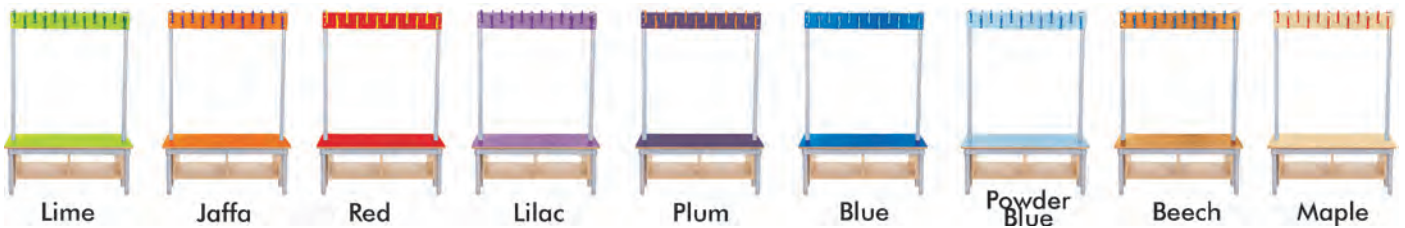

Single Sided Coat Tidys



- Choose your unit colour
- Choose your peg colour
- Choose you height

340mm



Single Sided Coat Tidys

Code	Width	Depth	Description	Price
KCCTS6	600mm	340mm	6 Hook Single Coat Tidy	
KCCTS7	700mm	340mm	7 Hook Single Coat Tidy	
KCCTS8	800mm	340mm	8 Hook Single Coat Tidy	
KCCTS9	900mm	340mm	9 Hook Single Coat Tidy	
KCCTS10	1000mm	340mm	10 Hook Single Coat Tidy	
KCCTS11	1100mm	340mm	11 Hook Single Coat Tidy	
KCCTS12	1200mm	340mm	12 Hook Single Coat Tidy	
KCCTS13	1300mm	340mm	13 Hook Single Coat Tidy	
KCCTS14	1400mm	340mm	14 Hook Single Coat Tidy	
KCCTS15	1500mm	340mm	15 Hook Single Coat Tidy	
KCCTS16	1600mm	340mm	16 Hook Single Coat Tidy	

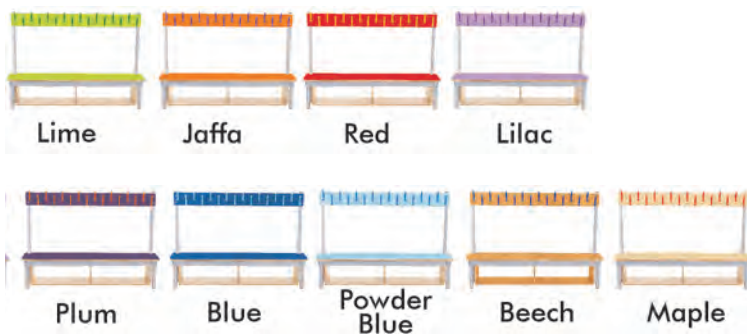

Double Sided Coat Tidys



- Choose your unit colour
- Choose your peg colour
- Choose you height

Double Sided Coat Tidys

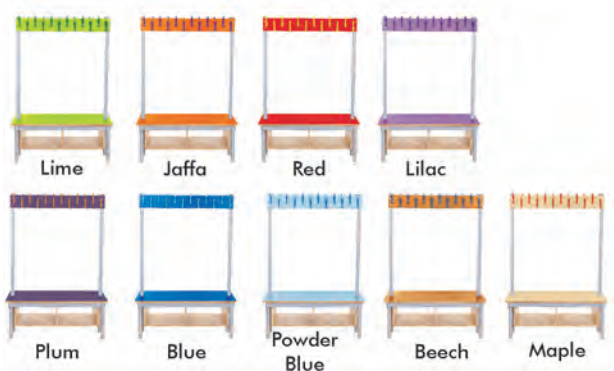

Code	Width	Depth	Description	Price
KCCTD12	600mm	600mm	12 Hook Double Coat Tidy	
KCCTD14	700mm	600mm	14 Hook Double Coat Tidy	
KCCTD16	800mm	600mm	16 Hook Double Coat Tidy	
KCCTD18	900mm	600mm	18 Hook Double Coat Tidy	
KCCTD20	1000mm	600mm	20 Hook Double Coat Tidy	
KCCTD22	1100mm	600mm	22 Hook Double Coat Tidy	
KCCTD24	1200mm	600mm	24 Hook Double Coat Tidy	
KCCTD26	1300mm	600mm	26 Hook Double Coat Tidy	
KCCTD28	1400mm	600mm	28 Hook Double Coat Tidy	
KCCTD30	1500mm	600mm	30 Hook Double Coat Tidy	
KCCTD32	1600mm	600mm	32 Hook Double Coat Tidy	

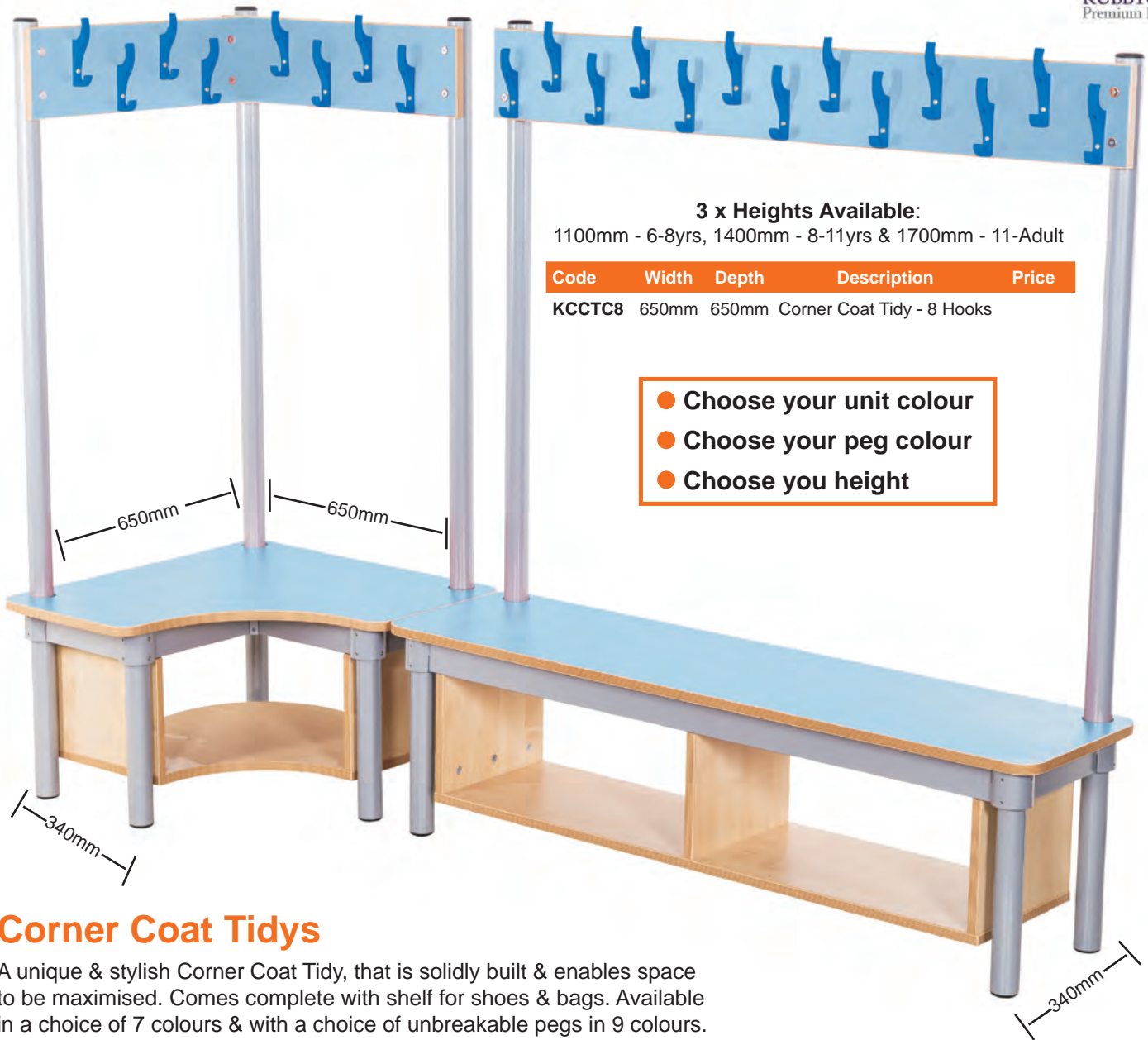

3 x Heights Available:

1100mm - 6-8yrs, 1400mm - 8-11yrs & 1700mm - 11-Adult

Code	Width	Depth	Description	Price
KCCTC8	650mm	650mm	Corner Coat Tidy - 8 Hooks	

- Choose your unit colour
- Choose your peg colour
- Choose you height

Corner Coat Tidys

A unique & stylish Corner Coat Tidy, that is solidly built & enables space to be maximised. Comes complete with shelf for shoes & bags. Available in a choice of 7 colours & with a choice of unbreakable pegs in 9 colours.

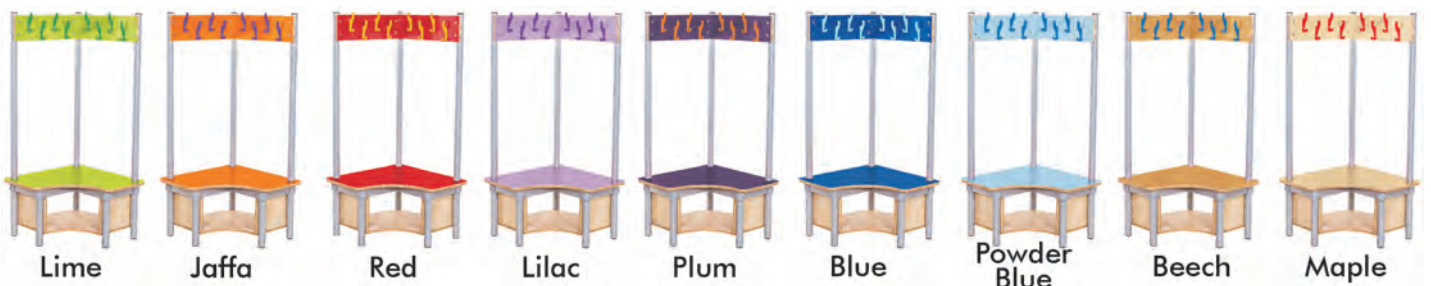

Fixings NOT supplied



200mm Height x 1000mm Width

Picture Hook Cloakroom Furniture

A fun way to store bags and coats, our new picture hook cloakroom furniture comes complete with hooks that feature a slot to add a personalised picture, name tag or drawing.

A simple and fun way of organising your cloakroom whilst allowing children to have their own individual space.

Choose from our mobile trolley with storage for bags and coats or our wall mounted hooks. Solidly constructed from strong 18mm MDF.

10 Hook Picture Rail - See above

Code	Description	Price
C72071	10 Hook Picture Rail	

Mobile Cloakroom Trolley

Code	Description	Price
C72069	1000mm High	
C72070	1300mm High	



915mm Width x 600mm Depth



Fixings NOT supplied

Kubbyclass® Mounted Coat Hooks

The KubbyClass® Wall Mounted Coat Hooks range is available in 18 lengths, ranging from 200mm all the way up to 2m in 100mm increments. Height of backboard is 155mm.

Unlike other manufacturers, we do NOT use aluminium pegs, that are prone to snap & leave sharp, dangerous edges behind, all our hooks are indestructible & will last a lifetime. They are not only tough, but designed with safety in mind.

There is also a choice of 9 hook stock colours to choose from. The backing rails are 18mm MDF laminate with a 2mm bump resistant ply effect edge.

Choice of board colours - or ALL Maple or Beech.



Maple supplied as standard.

Choose required rail width:

Code	Width	Description	Price
KCCH2	200mm	2 Hook Coat Rail	
KCCH3	300mm	3 Hook Coat Rail	
KCCH4	400mm	4 Hook Coat Rail	
KCCH5	500mm	5 Hook Coat Rail	
KCCH6	600mm	6 Hook Coat Rail	
KCCH7	700mm	7 Hook Coat Rail	
KCCH8	800mm	8 Hook Coat Rail	
KCCH9	900mm	9 Hook Coat Rail	
KCCH10	1000mm	10 Hook Coat Rail	
KCCH11	1100mm	11 Hook Coat Rail	
KCCH12	1200mm	12 Hook Coat Rail	
KCCH13	1300mm	13 Hook Coat Rail	
KCCH14	1400mm	14 Hook Coat Rail	
KCCH15	1500mm	15 Hook Coat Rail	
KCCH16	1600mm	16 Hook Coat Rail	
KCCH17	1700mm	17 Hook Coat Rail	
KCCH18	1800mm	18 Hook Coat Rail	
KCCH20	2000mm	20 Hook Coat Rail	

Choose from 200mm (2 hooks) to 2000mm (20 hooks)

UNBREAKABLE COATHOOKS
 in a choice of 9 colours!













Kubbyclass® Tables

Beautifully crafted classroom tables. Unique frame, with solid construction, these tables are built to last.

All Tables & Benches are available in the 7 standard colours plus beech & maple effect laminates. All have the 2mm plywood effect, bump resistant edging. Available in a range of shapes & 6 different heights!
 All KubbyClass Tables have solid tops & are NOT hollow in the middle.



Choice of top colours

			
Lime	Red	Lilac	Plum
			
Jaffa	Blue	Powder Blue	
			
Beech	Maple		



Ages 3-4	Height 460mm	E1
Ages 4-6	Height 530mm	E2
Ages 6-8	Height 590mm	E3
Ages 8-11	Height 640mm	E4
Ages 11-14	Height 710mm	E5
Ages 14-Adult	Height 760mm	E6

4 simple steps to ordering your KubbyClass Tables!

- 1 Choose Table Shape ✓
- 2 Choose Table Size ✓
- 3 Choose Table Height ✓
- 4 Choose Colour Theme ✓

Choice of colours!



Ages 3-4	Height 460mm	E1
Ages 4-6	Height 530mm	E2
Ages 6-8	Height 590mm	E3
Ages 8-11	Height 640mm	E4
Ages 11-14	Height 710mm	E5
Ages 14-Adult	Height 760mm	E6

**Kubbyclass®
Petal Tables**



4 Leaf Petal Table

5 Leaf Petal Table

6 Leaf Petal Table

9 Leaf Petal Table

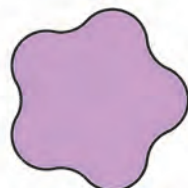

Code	Diameter	Price
KCTAB1	1200mm	

Code	Diameter	Price
KCTAB2	1200mm	

Code	Diameter	Price
KCTAB3	1200mm	

Code	Diameter	Price
KCTAB4	1200mm	

Remember to choose your table top colour

Kubbyclass® Hexagonal Tables



Remember to choose your table top colour

Hexagonal Tables

Code	Diameter	Price
KCTAB5	1200mm	

Ages 3-4	Height 460mm	E1
Ages 4-6	Height 530mm	E2
Ages 6-8	Height 590mm	E3
Ages 8-11	Height 640mm	E4
Ages 11-14	Height 710mm	E5
Ages 14-Adult	Height 760mm	E6

Kubbyclass® Trapezoidal Tables



Trapezoidal Tables

Code	Diameter	Price
KCTAB8	W1500mm x 600mm	

Ages 3-4	Height 460mm	E1
Ages 4-6	Height 530mm	E2
Ages 6-8	Height 590mm	E3
Ages 8-11	Height 640mm	E4
Ages 11-14	Height 710mm	E5
Ages 14-Adult	Height 760mm	E6

Kubbyclass® Kidney Bean Tables



Ages 3-4	Height 460mm	E1
Ages 4-6	Height 530mm	E2
Ages 6-8	Height 590mm	E3
Ages 8-11	Height 640mm	E4
Ages 11-14	Height 710mm	E5
Ages 14-Adult	Height 760mm	E6

Kidney Bean Tables

Code	Diameter	Price
KCTAB6	W1500mm x D800mm	

Kubbyclass® Semi-Circle Tables



Semi-Circle Tables

Code	Diameter	Price
KCTAB7	W1500mm x D750mm	

Ages 3-4	Height 460mm	E1
Ages 4-6	Height 530mm	E2
Ages 6-8	Height 590mm	E3
Ages 8-11	Height 640mm	E4
Ages 11-14	Height 710mm	E5
Ages 14-Adult	Height 760mm	E6



Kubbyclass® Circular Tables



Ages 3-4	Height 460mm	E1
Ages 4-6	Height 530mm	E2
Ages 6-8	Height 590mm	E3
Ages 8-11	Height 640mm	E4
Ages 11-14	Height 710mm	E5
Ages 14-Adult	Height 760mm	E6



900mm Circle

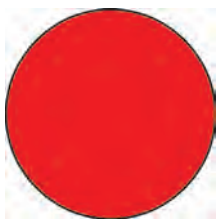

900mm Dia. Tables

Code	Price
KCTAB9	

1000mm Circle



1000mm Dia. Tables

Code	Price
KCTAB10	

1200mm Circle

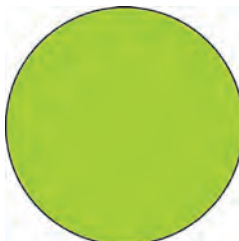

1200mm Dia. Tables

Code	Price
KCTAB11	

1500mm Circle

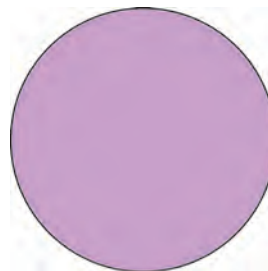

1500mm Dia. Tables

Code	Price
KCTAB12	

1600mm Circle



1600mm Dia. Tables

Code	Price
KCTAB13	

Kubbyclass® Square Tables

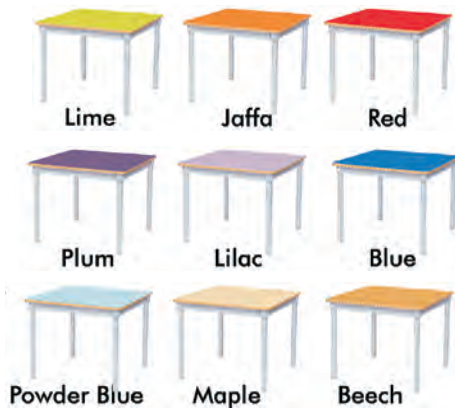

Ages 3-4	Height 460mm	E1
Ages 4-6	Height 530mm	E2
Ages 6-8	Height 590mm	E3
Ages 8-11	Height 640mm	E4
Ages 11-14	Height 710mm	E5
Ages 14-Adult	Height 760mm	E6

600mm Square



Code **Price**
 KCTAB14

700mm Square



Code **Price**
 KCTAB15

750mm Square



Code **Price**
 KCTAB16

800mm Square



Code **Price**
 KCTAB17

900mm Square



Code **Price**
 KCTAB18

1000mm Square



Code **Price**
 KCTAB19

1200mm Square



Code **Price**
 KCTAB20

1200mm Activity Table

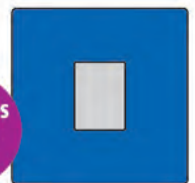

Includes fitted tray!

Code **Price**
 KCTAB37



Kubbyclass® Rectangular Tables



Remember to choose your table top colour



Ages 3-4	Height 460mm	E1
Ages 4-6	Height 530mm	E2
Ages 6-8	Height 590mm	E3
Ages 8-11	Height 640mm	E4
Ages 11-14	Height 710mm	E5
Ages 14-Adult	Height 760mm	E6

**Kubbyclass® Rectangle Tables
 1200mm x 600mm**

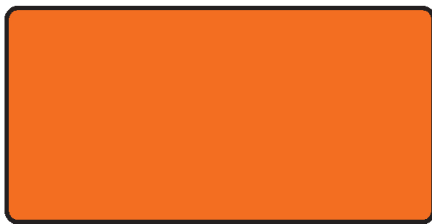

Code	Price
KCTAB21	

**Kubbyclass® Rectangle Tables
 1200mm x 750mm**



Code	Price
KCTAB22	

**Kubbyclass® Rectangle Tables
 1200mm x 800mm**



Code	Price
KCTAB23	

**Kubbyclass® Rectangle Tables
 1400mm x 600mm**

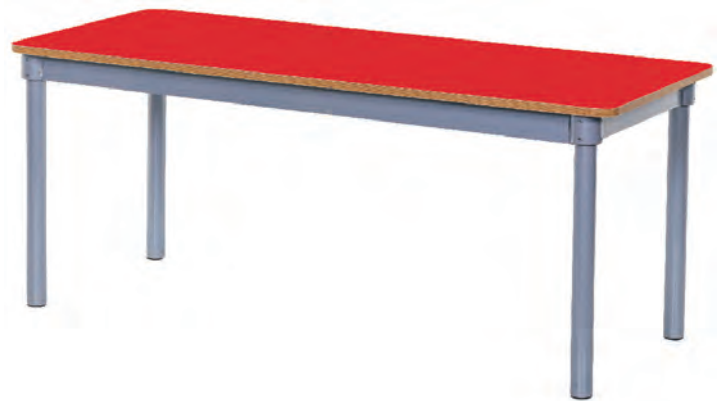

Code	Price
KCTAB24	



Ages 3-4	Height 460mm	E1
Ages 4-6	Height 530mm	E2
Ages 6-8	Height 590mm	E3
Ages 8-11	Height 640mm	E4
Ages 11-14	Height 710mm	E5
Ages 14-Adult	Height 760mm	E6

Remember to choose your table top colour



1400mm x 750mm

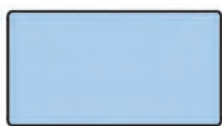

Code Price
KCTAB25

1400mm x 800mm

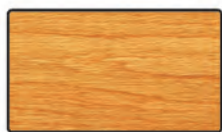

Code Price
KCTAB26

1500mm x 600mm

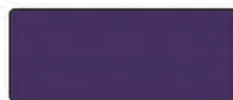

Code Price
KCTAB27

1500mm x 750mm



Code Price
KCTAB28

**Kubbyclass® Rectangle Tables
 1500mm x 800mm**



Code	Price
KCTAB29	

**Kubbyclass® Rectangle Tables
 1800mm x 600mm**

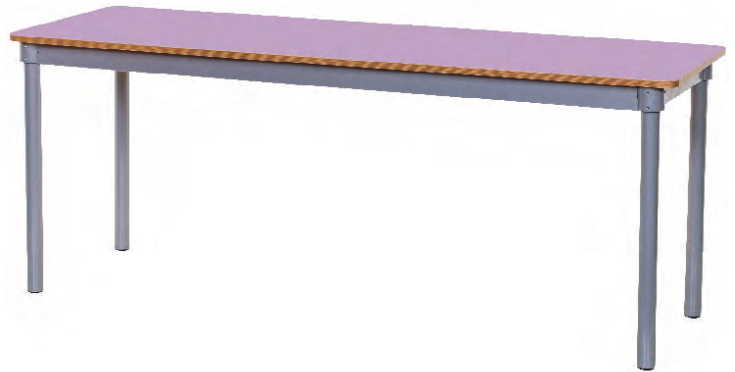

Code	Price
KCTAB30	

**Kubbyclass® Rectangle Tables
 1800mm x 750mm**

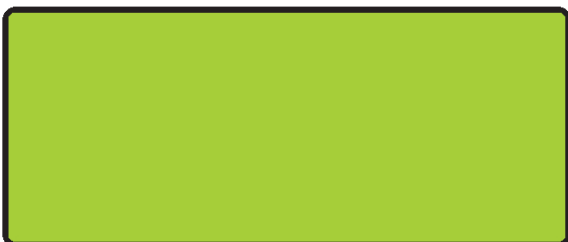
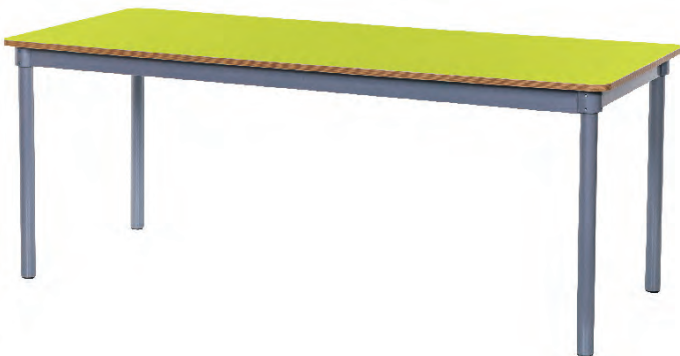

Code	Price
KCTAB31	

**Kubbyclass® Rectangle Tables
 1800mm x 800mm**



Code	Price
KCTAB32	

Kubbyclass® Bench Seats

High quality, strong & sturdy benches to use with the rectangle tables. Also great for use in changing rooms & dining rooms.



Ages 3-4	Height 260mm	E1
Ages 4-6	Height 310mm	E2
Ages 6-8	Height 350mm	E3
Ages 8-11	Height 380mm	E4
Ages 11-14	Height 430mm	E5
Ages 14-Adult	Height 460mm	E6

Choice of seat colours

600mm Bench Seat

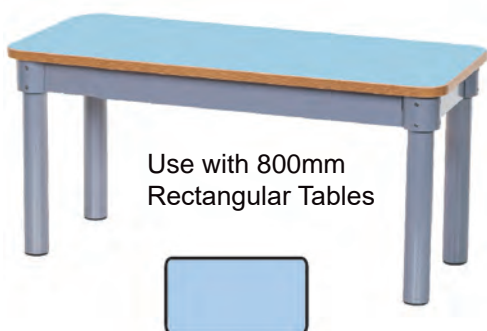

Use with 800mm Rectangular Tables

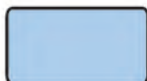

Code	Diameter	Price
KCTAB40	W600mm x 340mm	

700mm Bench Seat

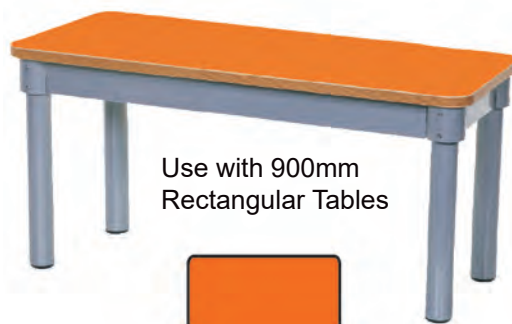

Use with 900mm Rectangular Tables



Code	Diameter	Price
KCTAB41	W700mm x 340mm	

Remember to choose your bench height. See above for sizes.

800mm Bench Seat

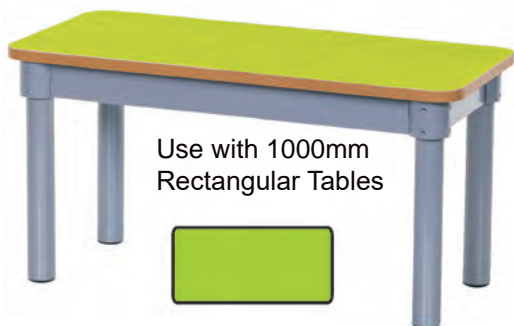

Use with 1000mm Rectangular Tables



Code	Diameter	Price
KCTAB42	W800mm x 340mm	

900mm Bench Seat

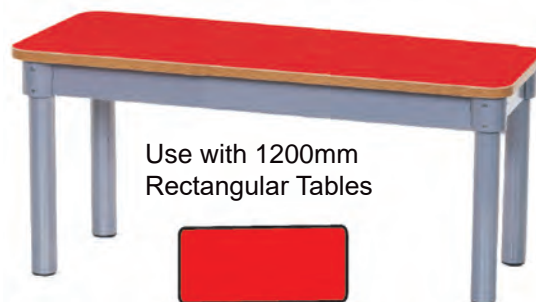

Use with 1200mm Rectangular Tables



Code	Diameter	Price
KCTAB43	W900mm x 340mm	

1000mm Bench Seat

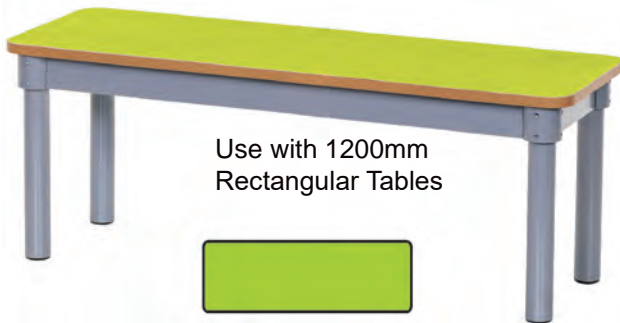

Use with 1200mm
Rectangular Tables



Code	Diameter	Price
KCTAB33	W1000mm x 340mm	

1200mm Bench Seat

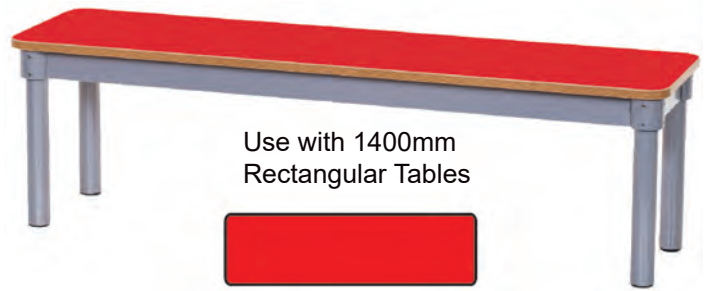

Use with 1400mm
Rectangular Tables



Code	Diameter	Price
KCTAB34	W1200mm x 340mm	

Remember to choose
your bench height.
See above for sizes.

1300mm Bench Seat

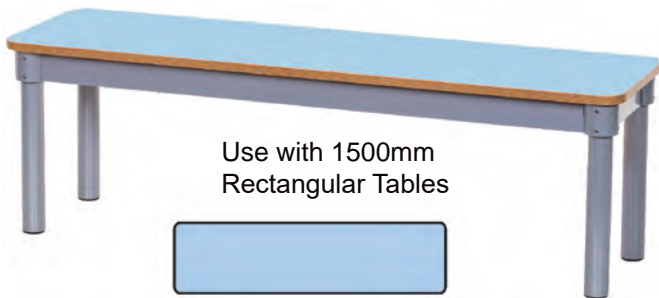

Use with 1500mm
Rectangular Tables



Code	Diameter	Price
KCTAB35	W1300mm x 340mm	

1600mm Bench Seat



Use with 1800mm
Rectangular Tables



Code	Diameter	Price
KCTAB36	W1600mm x 340mm	

Remember to choose
your bench height.
See above for sizes.



Ages 3-4	Height 260mm	E1
Ages 4-6	Height 310mm	E2
Ages 6-8	Height 350mm	E3
Ages 8-11	Height 380mm	E4
Ages 11-14	Height 430mm	E5
Ages 14-Adult	Height 460mm	E6



Kubbyclass® Early Years

A superior collection of Early Years storage and display furniture to enhance any setting. This exciting range has been designed with the help of Early Years Centre staff to ensure that all items are suitable for their environment. Solidly constructed and delivered fully assembled you can choose from an all Maple finish or add Lilac or Powder Blue top to any of your units to give a hint of colour and interest for your children.

The curved sides have been incorporated into the design to avoid any sharp and dangerous corners.

Open units with no backs allow children to access the items from both sides and the staff can see through and monitor young learners.

Just a few comments we have received:

"The coloured furniture brightens up and refreshes our environment and with the colours being pastel, goes with our original colour scheme."

"Our new furniture is the perfect height for our older children to stand and play at, and has ample storage for toys and all of our equipment. The toys can be easily accessed by the children and the size of the furniture pieces allows several children to play at once."

"It is very hard to find furniture for our under 2's, so we especially love the lower pieces that are ideal for our babies who are not yet walking. The Early Years Foundation Stage (EYFS) is our curriculum and it suggests that toys be accessible at all times to the children, we can now allow this to happen."

"We love the way the pieces have been designed to fit together, being able to do so makes our learning areas flow much better."



All units available in 3 heights



1 Metre High 12 Hook Cloakroom Tidy

H1000mm x W1395mm x D460mm



Upholstered seat with durable carpet.

1m High 12 Hook Cloakroom Tidy		
B74033C	4 x Clear Trays	

Deep tray sizes:
H150mm x W312mm x D427mm

Carpeted Cloakroom Seat

H440mm x W1395mm x D460mm



Upholstered seat with durable carpet.

Carpeted Cloakroom Seat		
B74040	4 x Clear Trays	



Low Level 1 Tier Unit with Back

H440mm x W900mm x D370mm



Low Level 1 Tier Unit with Back
B74001

Low Level 1 Tier Unit - Open Back

H440mm x W900mm x D370mm



Low Level 1 Tier Unit - Open Back
B74005

Choose your top colour



Low Level 1 Tier Tray Unit with Back

H440mm x W900mm x D370mm



Clear
Trays

Low Level 1 Tier Tray Unit with Back
B74002C Clear Cubby Trays

Cubby tray sizes:
H150mm x W260mm x D312mm

Low Level 1 Tier Tray Unit - Open Back

H440mm x W900mm x D370mm



Clear
Trays

Low Level 1 Tier Tray Unit - Open Back
B74006C Clear Cubby Trays

Cubby tray sizes:
H150mm x W260mm x D312mm





Low Level 1 Tier Cube Unit with Back

H440mm x W900mm x D370mm



Low Level Cube Unit with Back

B74003

Choose your top colour



Low Level 1 Tier Cube Unit - Open Back

H440mm x W900mm x D370mm



Low Level Cube Unit - Open Back

B74007

Low Level 1 Tier Tray Cube Unit with Back

H440mm x W900mm x D370mm



Clear Trays

Low Level 1 Tier Tray Cube Unit with Back

B74004C Clear Cubby Trays

Cubby tray sizes:
H150mm x W260mm x D312mm

Low Level 1 Tier Tray Cube Unit - Open Back

H440mm x W900mm x D370mm



Clear Trays

Low Level 1 Tier Tray Cube Unit - Open Back

B74008C Clear Cubby Trays

Cubby tray sizes:
H150mm x W260mm x D312mm



2 Tier Unit with Back
H710mm x W900mm x D370mm

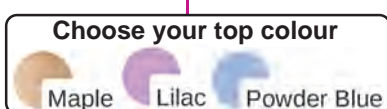

2 Tier Unit - Open Back
H710mm x W900mm x D370mm



2 Tier Unit with Back
B74009

2 Tier Unit - Open Back
B74013

2 Tier Tray Unit with Back

H710mm x W900mm x D370mm



2 Tier Tray Unit with Back	
B74010C	6 x Clear Cubby Trays

**Clear
Trays**

2 Tier Tray Unit - Open Back

H710mm x W900mm x D370mm



2 Tier Tray Unit - Open Back	
B74014C	6 x Clear Cubby Trays

**Clear
Trays**

Choose your top colour



2 Tier Cube Unit with Back

H710mm x W900mm x D370mm



2 Tier Cube Unit with Back	
B74011	

2 Tier Cube Unit - Open Back

H710mm x W900mm x D370mm



2 Tier Cube Unit - Open Back	
B74015	

Choose your top colour



2 Tier Tray Cube Unit with Back

H710mm x W900mm x D370mm



Cubby tray sizes:
H150mm x W260mm x D312mm

2 Tier Tray Cube Unit with Back	
B74012C	6 x Clear Cubby Trays

**Clear
Trays**

2 Tier Tray Cube Unit - Open Back

H710mm x W900mm x D370mm



Cubby tray sizes:
H150mm x W260mm x D312mm

2 Tier Tray Cube Unit - Open Back	
B74016C	6 x Clear Cubby Trays

**Clear
Trays**



3 Tier Unit with Back
H900mm x W900mm x D370mm



3 Tier Unit with Back	
B74017	<input type="checkbox"/>

3 Tier Unit - Open Back
H900mm x W900mm x D370mm



3 Tier Unit - Open Back	
B74021	<input type="checkbox"/>

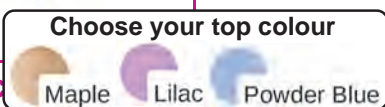

3 Tier Tray Unit with Back
H900mm x W900mm x D370mm



3 Tier Tray Unit with Back	
B74018C	9 x Clear Cubby Trays <input type="checkbox"/>

Clear Trays

3 Tier Tray Unit - Open Back
H900mm x W900mm x D370mm



3 Tier Tray Unit - Open Back	
B74022C	9 x Clear Cubby Trays <input type="checkbox"/>

Clear Trays

3 Tier Cube Unit with Back

H900mm x W900mm x D370mm



3 Tier Cube Unit with Back

B74019

3 Tier Cube Unit - Open Back

H900mm x W900mm x D370mm



3 Tier Cube Unit - Open Back

B74023

Choose your top colour

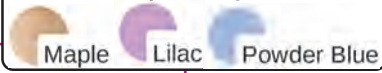

3 Tier Tray Cube Unit with Back

H900mm x W900mm x D370mm



3 Tier Tray Cube Unit with Back

B74020C 9 x Clear Cubby Trays

Clear
Trays

3 Tier Tray Cube Unit - Open Back

H900mm x W900mm x D370mm



3 Tier Tray Cube Unit - Open Back

B74024C 9 x Clear Cubby Trays

Clear
Trays





1 Tier 90° Corner Unit
H440mm x W470mm

Choose your top colour



3 Tier 90° Corner Unit
H900mm x W470mm



1 Tier 90° Degree Corner Unit
B74027

2 Tier 90° Corner Unit
H710mm x W470mm



2 Tier 90° Degree Corner Unit
B74028



3 Tier 90° Degree Corner Unit
B74029

1 Tier 45° Corner Unit

H440mm x W900mm



1 Tier 45° Corner Storage Unit

B74047

3 Tier 45° Corner Unit

H900mm x W900mm



3 Tier 45° Corner Storage Unit

B74049

2 Tier 45° Corner Unit

H710mm x W900mm



2 Tier 45° Corner Storage Unit

B74048

Choose your top colour



Start learning with



KUBBYCLASS®
Early Years



Low Mobile Kinderbox

H300mm x W610mm x D600mm



Low Mobile Kinderbox	
A63002	



Bookcase & Kinderbox

H710mm x W1000mm x D370mm



Bookcase & Kinderbox	
B74050	

3 Tier Stepped Storage Cube

H980mm x W1020mm x D370mm



Right Hand Unit

Left Hand Unit

3 Tier Stepped Storage Cube Unit

B74057	Left hand unit	
B74058	Right hand unit	

3 Tier Stepped Storage Cube with Trays

H980mm x W1020mm x D370mm



Right Hand Unit

Left Hand Unit

3 Tier Stepped Storage Cube Unit with Trays

B74051C	Left hand unit	6 x Clear Trays	
B74055C	Right Hand Unit	6 x Clear Trays	

Cubby tray sizes:

H150mm
W260mm
D312mm



Low Level Play & Book Store with Dividers

H440mm x W900mm x D370mm

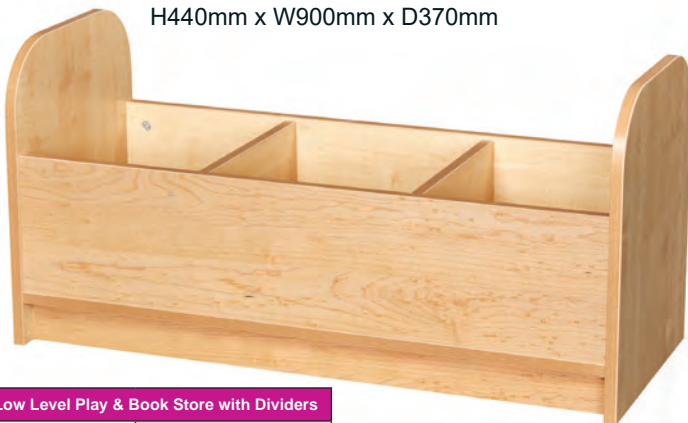

Low Level Play & Book Store with Dividers

B74046	
---------------	--

Low Level Play & Book Store

H440mm x W900mm x D370mm



Low Level Play & Book Store

B74052	
---------------	--



1 Metre High Display Bookcase
H1000mm x W1000mm x D370mm

1 Metre High Storage Bookcase with 3 Trays
H1000mm x W1000mm x D370mm



Cubby tray sizes:
H150mm x W260mm x D312mm

1m High Display Bookcase	
B74030	

1m High Display Bookcase with 3 Trays	
B74053C	3 x Clear Cubby Trays

**Clear
Trays**

1 Metre High Bookcase
H1000mm x W1000mm x D370mm



1m High Bookcase	
B74031	

1 Metre High Bookcase with 9 Trays
H1000mm x W1000mm x D370mm



Cubby tray sizes:
H150mm x W260mm x D312mm

1m High Bookcase with 9 Trays	
B74054C	9 x Clear Cubby Trays

Clear Trays



Single Shallow 6 Tray Unit

H735mm x W356mm x D460mm



Shallow tray sizes:

H75mm x W312mm x D427mm

Single Column 6 Shallow Tray Unit

B74043 6 x Clear Shallow Trays

Double Shallow 12 Tray Unit

H735mm x W690mm x D460mm



Shallow tray sizes:

H75mm x W312mm x D427mm

Double Column 12 Shallow Tray Unit

B74044 12 x Clear Shallow Trays

Triple Shallow 18 Tray Unit

H735mm x W1024mm x D460mm



Shallow tray sizes:

H75mm x W312mm x D427mm

Triple Column 18 Shallow Tray Unit

B74045 18 x Clear Shallow Trays

2 Tier Easy Access Tray Trolley

H710mm x W1000mm x D460mm



2 Tier Easy Access Tray Trolley

B74036 6 x Clear Double Trays

Double tray sizes:

H150mm x W312mm x D427mm

3 Tier Easy Access Tray Trolley

H900mm x W1000mm x D460mm



3 Tier Easy Access Tray Trolley

B74037 9 x Clear Double Trays

Double tray sizes:

H150mm x W312mm x D427mm





6 Leaf Petal Table

SIZE 0	H400mm	Nursery
SIZE 1	H460mm	3-4 Years
SIZE 2	H530mm	5-6 Years

6 Leaf Petal Table - 3 Heights	
BKCTAB3	



Early Years Chair

Early Years Chairs		
SIZE 1	Height 260mm	

Available colours: Red/Yellow/Blue/Green

Early Years Chairs		
SIZE 2	Height 310mm	

Available colours: Red/Yellow/Blue/Green/Lime/Purple

2 Tier Extra Wide Shelving with Back

H710mm x W1200mm x D370mm

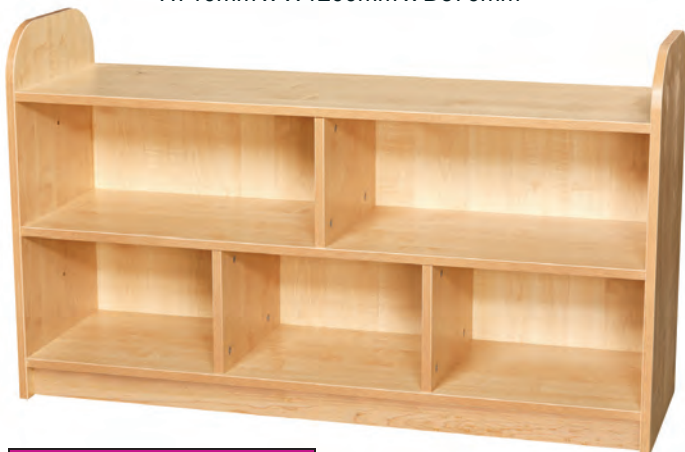

2 Tier Extra Wide Shelving with Back	
B74025	

2 Tier Extra Wide Shelving - Open Back

H710mm x W1200mm x D370mm



2 Tier Extra Wide Shelving - Open Back	
B74026	



acorn

Acorn Early Years soft seating is a range of fun, bright and creative soft seating shapes that can be used to build exciting learning and play areas.

Crafted in the UK and finished by hand. This range is sewn in our Cadet performance vinyl which is latex free, ultra durable and stain resistant. The seating can be easily wiped

clean and features an anti-bacterial Acryltron protective coating.

This range is made from high density foam that holds its' shape. Youngest learners can use the seating to support themselves whilst taking first steps, and older children can comfortably sit for story time or group play.

All fabric choices are flame retardant to ignition source 5 and comply to BS5852 part 2.





Fabric Choices

Cadet Colour choices - the market leading vinyl upholstery range, feels even softer, works even harder and is available in a range of bright and bold colours. Suitable for healthcare & educational environments. Cadet Colours are fire retardant, protected by Acrylton for enhanced durability and shield plus antibacterial defence.

Other colours are available, please call for details.



Cobalt Blue 104



Apple Zest 222

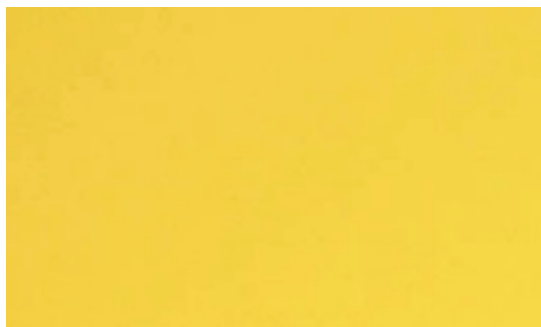

Lemon Zest 303



Tangerine Zest 438



Scarlet Red 440



Violet Zest 128

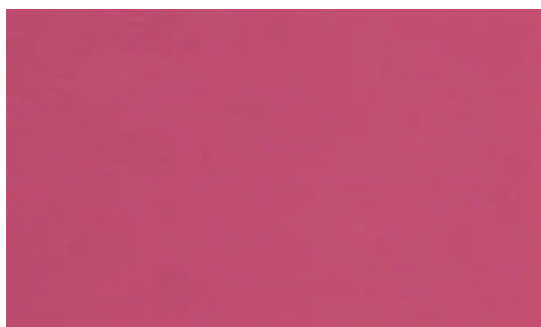

Fuschia 608



Turquoise 115



Large Wedge Foam Seat



Large Wedge Foam Seat	
D81007	H250mm x W540mm x D540mm.

Large Wedge Foam Seats - Set of Three



Large Wedge Foam Seats - Set of Three	
D81049	H250mm x W540mm x D540mm



- Link together or use singularly
- Ideal as a comfortable reading or storytime seat
- Available in packs of 1, 3 or 6
- Combine with other products to make more complex shapes
- Anti-bacterial wipe clean vinyl

Large Wedge Foam Seats Set of Six

Large Wedge Foam Seats - Set of Six	
D81050	H250mm x W540mm x D540mm

Large Hexagon Foam Seat



Large Hexagon Foam Seat	
D81006	250mm High x 600mm Dia.



Large Hexagon Foam Seats - Set of Three



Large Hexagon Foam Seats - Set of Three	
D81042	250mm High x 600mm Dia.

Large Hexagon Foam Seats - Set of Six



Large Hexagon Foam Seats - Set of Six	
D81043	250mm High x 600mm Dia.

- Honeycomb linking design
- Link together or use singularly
- Create geometric patterns
- Available in packs of 1, 3 or 6
- Can be used as a maths resource
- Anti-bacterial wipe clean vinyl





Cube Foam Seat



Cube Foam Seat		
D81003	H250mm x W350mm x D350mm	

Cube Foam Seats - Set of Four



Cube Foam Seats - Set of Four		
D81044	H250mm x W350mm x D350mm	

Choice of vinyl seat colours

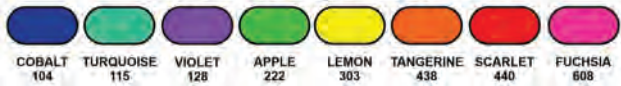

- Simple & sleek cube shape
- Available in packs of 1, 3 or 6
- Compliments any space
- Soft foam construction
- Anti-bacterial wipe clean vinyl

Cube Foam Seats Set of Six

Cube Foam Seats - Set of Six		
D81045	250mm High x 350mm Dia.	



Activity Bench with Beam Seat

Activity Bench with Beam Seat	
D81099	H608mm x W860mm x D380



Activity Bench with Two Cube Seats

Activity Bench with Two Cube Seats	
D81098	H608mm x W860mm x D380



Wide Activity Bench with Three Cube Seats

Activity Bench with Three Cube Seats	
D81100	H608mm x W1150mm x D380mm





Large Square Foam Seat

Large Square Foam Seat		
D81009	H250mm x W600mm x D600mm	

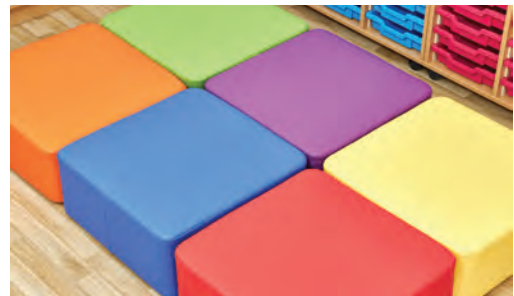

Large Square Foam Seats - Set of Six		
D81278	H250mm x W600mm x D600mm	

Large Square Foam Seats - Set of Three

Large Square Foam Seats - Set of Three		
D81048	H350mm x W600mm x D600mm	

- Seats multiple children
- Use as seating or play table
- Available in packs of 1, 3 or 6
- Combine to construct a multicoloured island
- Soft foam construction
- Anti-bacterial wipe clean vinyl



Beam Foam Seat



Beam Foam Seat	
D81008	H250mm x W700mm x D350mm

Beam Foam Seats - Set of Three



Beam Foam Seats - Set of Three	
D81046	H250mm x W700mm x D350mm

- Seats two children
- Bright & modern colours
- Available in packs of 1, 3 & 5
- Build a run or use individually
- Perfect for reading areas
- Anti-bacterial wipe clean vinyl

Beam Foam Seats - Set of Five



Beam Foam Seats - Set of Five	
D81047	H250mm x W700mm x D350mm

Choice of vinyl seat colours

COBALT 104	TURQUOISE 115	VIOLET 128	APPLE 222	LEMON 303	TANGERINE 438	SCARLET 440	FUCHSIA 608





Large Bite Foam Seat



Large Bite Foam Seat	
D81010	250mm High x 680mm Dia:

Large Bite Foam Seat - Set of Six	
D81277	250mm High x 680mm Dia:



- Interlocking bite design
- Can be used in a number of layouts
- Works with other products from the Primary Range
- Great for reading corners or storytime
- Encourages collaborative work
- Anti-bacterial wipe clean vinyl

Large Bite Foam Seats - Set of Three

Large Bite Foam Seats - Set of Three	
D81051	250mm High x 680mm Dia:



Choice of vinyl seat colours

COBALT 104	TURQUOISE 115	VIOLET 128	APPLE 222	LEMON 303	TANGERINE 438	SCARLET 440	FUCHSIA 608



- Interlocking bite design
- Can be used in a number of layouts
- Works with other products from the Primary Range
- Great for reading corners or storytime
- Encourages collaborative work
- Anti-bacterial wipe clean vinyl

Mini Bite Foam Seat

Mini Bite Foam Seat	
D81001	250mm High x 350mm Dia:



Choice of vinyl seat colours

COBALT 104	TURQUOISE 115	VIOLET 128	APPLE 222	LEMON 303	TANGERINE 438	SCARLET 440	FUCHSIA 608

Mini Bite Foam Seat - Set of Four

Mini Bite Foam Seat - Set of Four	
D81036	250mm High x 350mm Dia:



Mini Bite Foam Seat - Set of Six

Mini Bite Foam Seat - Set of Six	
D81037	250mm High x 350mm Dia:





Mini Hexagon Foam Seat



Mini Hexagon Foam Seat	
D81032	250mm High x 390mm Dia:

Mini Hexagon Foam Seats - Set of Three



Mini Hexagon Foam Seats - Set of Three	
D81083	250mm High x 390mm Dia:



- Honeycomb design
- Create interesting geometric shapes
- Available in packs of 1, 3 or 6
- Can be used as a maths resource
- Anti-bacterial wipe clean vinyl

Mini Hexagon Foam Seats - Set of Six

Mini Hexagon Foam Seats - Set of Six	
D81084	250mm High x 390mm Dia:



Large Dot Foam Seat



Large Dot Foam Seat	
D81087	250mm High x 600mm Dia:

Large Dot Foam Seats - Set of Six



Large Dot Foam Seats - Set of Six	
D81096	250mm High x 600mm Dia:



Large Dot Foam Seats - Set of Four



Large Dot Foam Seats - Set of Four	
D81095	250mm High x 600mm Dia:

- Circular shapes seat multiple children
- Can be used in a number of layouts
- Works with other products from the Primary Range
- Available in pack of 1, 3 or 6
- Encourages collaborative work
- Anti-bacterial wipe clean vinyl

Choice of vinyl seat colours

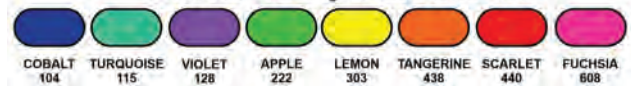



Mini Dot Foam Seat



Mini Dot Foam Seat	
D81004	250mm High x 350mm Dia:

Mini Dot Foam Seats - Set of Four



Mini Dot Foam Seats - Set of Four	
D81053	250mm High x 350mm Dia:



- Simple circular dot shape
- Create collaborate circles
- Perfect for comfortable reading seats
- Available in packs of 1, 3 or 6
- Available in bright & modern colours
- Soft foam construction
- Anti-bacterial wipe clean vinyl

Mini Dot Foam Seats - Set of Six

Mini Dot Foam Seats - Set of Six	
D81054	250mm High x 350mm Dia:



Sofa Suite Set with Low Table

Sofa Suite Set with Low Table	
D81263	Seat Height 350mm

Choice of vinyl covers

FOREST 229	MUSTARD	COBALT 104	TURQUOISE 115	VIOLET 128	APPLE 222	LEMON 303	TANGERINE 438	SCARLET 440	FUCHSIA 608



Early Years Tub Chair

Early Years Tub Chair - Seat Height 350mm	
D81212	H480mm x W480mm x D500mm

Early Years Tub Sofa

Early Years Tub Sofa - Seat Height 350mm	
D81283	H480mm x W900mm x D500mm



Tub Chair Set with Low Table

Early Years Tub Chair Set with Low Table- Seat Height 350mm	
D81262	Seat Height 350mm



Flower Foam Seats - Set of Six

- Fun & inviting design
- Encourages collaboration & group work
- Supplied as a set of 6 petals & 1 dot
- Adds a brilliant focal point to your space
- Centre piece can be used as a work surface
- Anti-bacterial wipe clean vinyl

Flower Foam Seats - Set of Six		
D81097	250mm High x 1100mm Dia:	

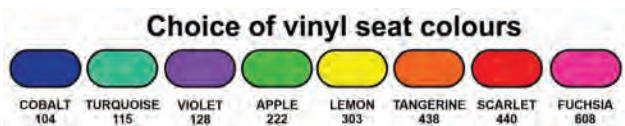

Simple Shapes Foam Seats - Set of Three

Simple Shapes Foam Seats - Set of Three		
D81038	250mm High x 350mm Dia Each	



Single Petal Foam Seat



Single Petal Foam Seat	
D81005	H250mm x W720mm x D520mm

Dot Foam Seat



Dot Foam Seat	
D81004	250mm High x 350mm Dia:



Dot & Three Petal Foam Seats



Dot & Three Petal Foam Seats	
D81040	H250mm x 1790mm Dia

Dot & Four Petal Foam Seats



Dot & Four Petal Foam Seats	
D81041	H250mm x 1790mm Dia





Activity Table with Four Cube Seats



Activity Table with Four Cube Seats		
D81103	H468mm x W900mm x D900mm	

Activity Table with Four Dot Seats



Activity Table with Four Dot Seats		
D81102	H468mm x W900mm x D900mm	

- Perfect as a reading table
- Encourages group work & collaboration
- Available with Cube or Dot seats
- Rounded edges for added safety
- Seating tuck under for easy storage
- Anti-bacterial wipe clean vinyl seats

acorn

Choice of vinyl seat colours

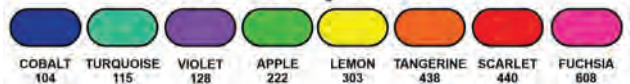

Activity Bench with Two Dot Seats



Activity Bench with Two Dot Seats		
D81101	H608mm x W860mm x D380mm	

Wide Activity Bench with Three Dot Seats



Activity Bench with Three Dot Seats		
D81192	H608mm x W1150mm x D380mm	





Fish Foam Seat



Fish Foam Seat		
D81035	H250mm x W800mm x D400mm	

Fish Foam Seats - Set of Three



Fish Foam Seats - Set of Three		
D81088	H250mm x W800mm x D400mm	



- **Interlocking creative fish shape**
- Can be linked or used singularly
- Available in packs of 1, 3 or 6
- Creates a focal point in any room
- Encourages creativity & design
- Anti-bacterial wipe clean vinyl

Fish Foam Seats - Set of Six

Fish Foam Seats - Set of Six		
D81089	H250mm x W800mm x D400mm	



Mini Wedge Foam Seat



Mini Wedge Foam Seat		
D81147	H250mm x W350mm x D350mm	

Mini Wedge Foam Seats - Set of Six



Mini Wedge Foam Seats - Set of Six		
D81149	H250mm x W350mm x D350mm	

Mini Wedge Foam Seats - Set of Three



Mini Wedge Foam Seats - Set of Three		
D81148	H250mm x W350mm x D350mm	



Choice of vinyl seat colours

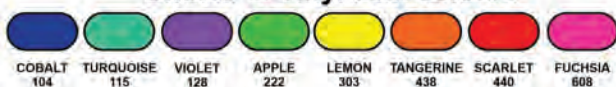



Early Years Bean Bag Chair

Early Years Bean Bag Chair	
D81151	450mm High x 500mm Dia.



Early Years Support Bean Bag Seat

Early Years Support Bean Bag Seat	
D81152	250mm High x 700mm Wide x 500mm Deep



Oversized Single Floor Cushion

Oversized Single Floor Cushion	
D81150	200mm High x 800mm Wide x 800mm Deep



- Early Years supporting bean bag chair
- Hardwearing indoor/outdoor fabric
- Integrated back support
- Ideal for compact learning areas



Fabric Choices

Acorn Bean Bags are upholstered in a robust and long lasting yet soft to the touch showerproof fabric. Suitable for use indoors and out, these bean bags are perfect for taking the classroom outside. Available in a range of bright and bold colours. Each bean bag features an inner bag to prevent any loss of filling. Larger bean bags are designed to be perfectly ergonomic whilst smaller bean bags can be easily transported and moved. The Acorn Range of Bean Bags caters for all age groups and most products can be used between Key Stages.

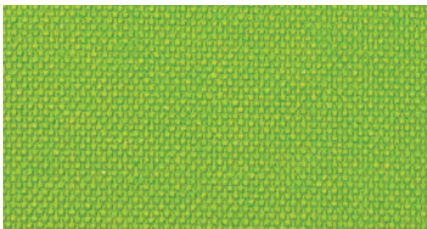

Lime Green



Plum

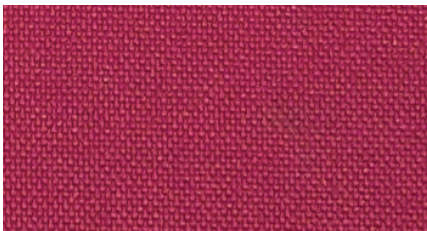

Cerise Pink



Royal Blue

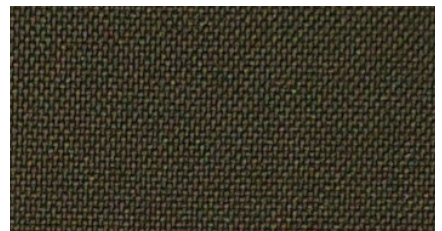

Grey



Orange

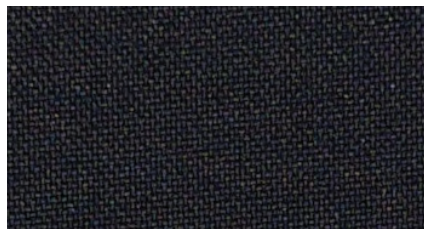

Navy

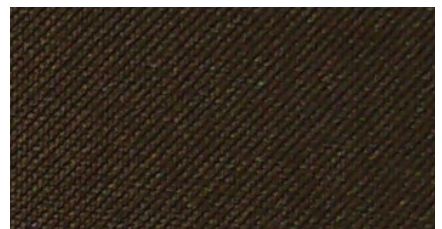

Brown

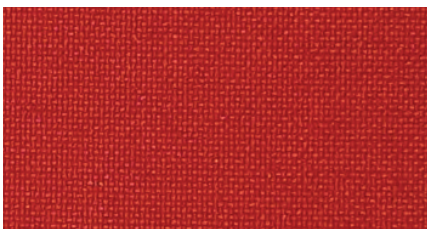

Red

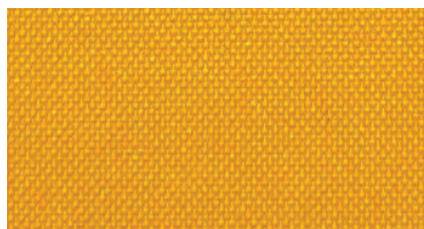

Yellow

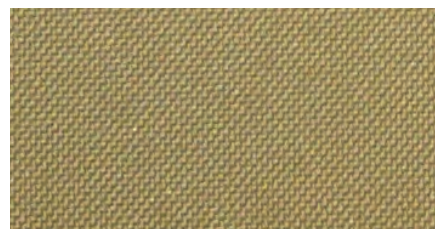

Sand

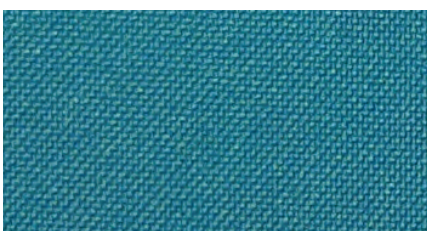

Aqua



Forest Green

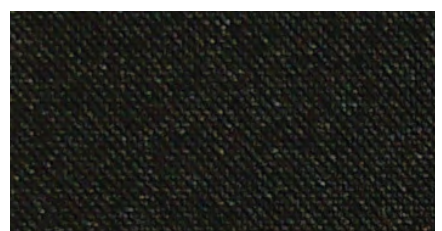

Black



Bean Pod Seat - Set of Four



Bean Pod Seat - Set of Four		
D81105	200mm High x 380mm Dia. Each	



Bean Pod Seat - Set of Six



Bean Pod Seat - Set of Six		
D81106	200mm High x 380mm Dia. Each	



- Compact & lightweight
- Stackable for easy storage
- Comfortable low seat
- Bright & modern colours
- Suitable for indoors & outdoors





Bean Cube Seat - Set of Three



Bean Cube Seat - Set of Three		
D81110	H380mm x W380mm x D380mm	



Bean Cube Seat - Set of Four



Bean Cube Seat - Set of Four		
D81111	H380mm x W380mm x D380mm	



Bean Cube Seat - Set of Six



Bean Cube Seat - Set of Six		
D81112	H380mm x W380mm x D380mm	



- Stackable for easy storage
- Hardwearing indoor/outdoor fabric
- Lightweight & portable
- Suitable for most age groups
- Versatile for a range of activities



Large Bean Bag Bench



Large Bean Bag Bench	
D81115	H380mm x W1400mm x D300mm



Two Seater Bean Bag Bench



Two Seater Bean Bag Bench	
D81113	H350mm x W700mm x D350mm



Two Seater Bean Pod



acorn

- Seats two children
- Made from showproof fabric
- **Inner bag prevents loss of filling**
- Stackable & easy to store
- Great for working in groups or pairs

Two Seater Bean Pod Seat	
D81107	H200mm x W800mm x D500mm



Two Seater Bean Pod - Set of Two



Two Seater Bean Pod Seat - Set of Two	
D81108	H200mm x W800mm x D500mm



Choice of bean bag fabric colours

LIME GREEN	CERISE PINK	ORANGE	RED	AQUA	ROYAL BLUE	NAVY
FOREST GREEN	YELLOW	PLUM	GREY	BROWN	SAND	BLACK





Large Bean Bag Block



Large Bean Bag Block	
D81114	H350mm x W1400mm x D600mm





Oversized Single Floor Cushion



Oversized Single Floor cushion		
D81150	H200mm x W800mm x D800mm	



- Sizes for all age groups
- Larger sizes seat multiple children
- Made from showerproof fabric
- **Inner bag prevents loss of filling**
- **Deep fill bean bags**
- Great for working in groups or pairs



Large Floor Cushion Bean Bag



Large Floor Cushion Bean Bag		
D81120	H200mm x W1200mm x D1200mm	





Extra Large Floor Cushion Bean Bag



Extra Large Floor Cushion Bean Bag		
D81119	H200mm x W1300mm x D1000mm	



Choice of bean bag fabric colours

LIME GREEN	CERISE PINK	ORANGE	RED	AQUA	ROYAL BLUE	NAVY
FOREST GREEN	YELLOW	PLUM	GREY	BROWN	SAND	BLACK

Jumbo Floor Cushion Bean Bag



Jumbo Floor Cushion Bean Bag		
D81121	H200mm x W1500mm x D1200mm	



Easy Carry Reading Bean Bag Pod



- Carry handle
- Comfortable classic design bean bag
- Suitable for use indoors or outdoors
- **Inner bag prevents any loss of filling**
- Available in bright & modern colours



Easy Carry Reading Bean Bag Pod		
D81117	400mm High x 550mm Dia.	



High Back Primary Bean Bag



- Features a tall supporting back panel
- Attractive & fun design
- Suitable for use indoors & outdoors
- Perfect for the classroom
- Available in modern & bright colours

High Back Primary Bean Bag		
D81116	700mm High x 500mm Wide x 520mm Deep	



Early Years Bean Bag Chair



Early Years Bean Bag Chair		
D81151	450mm High x 500mm Dia.	



- Featuring a supporting back panel
- Comfortable & inviting bean bag
- Suitable for use indoors & outdoors
- Ideal for group work & reading corners
- Available in bright & modern colours



Primary Bean Bag Chair



Primary Bean Bag Chair		
D81118	500mm High x 600mm Dia.	



Large Bean Bag Chair



Large Bean Bag Chair		
D81123	750mm High x 750mm Dia.	



Primary Study Pod Bean Bag

- Great for independent reading & study
- Ergonomic & supporting design
- **Inner bag prevents any loss of filling**
- Ideal for multiple age groups
- Available in bright & modern colours



Primary Study Pod Bean Bag	
D81122	800mm High x 600mm Dia.



Large Study Pod Bean Bag	
D81039	800mm High x 800mm Dia.



Large Study Pod Bean Bag

- Ideal for older & taller children
- Offers positive back & neck support
- **Inner bag prevents any loss of filling**
- **Beads mould around body for ergonomic fit**
- Available in bright & modern colours



- Ideal for older & taller children
- Offers positive back & neck support
- **Inner bag prevents any loss of filling**
- **Beads mould around body for ergonomic fit**
- Available in bright & modern colours

Large Breakout Bean Bag Chair

Large Breakout Bean Bag Chair		
D81156	900mm High x 900mm Dia.	



Large Breakout Bean Bag Chair Set of Four

Large Breakout Bean Bag Chair - Set of Four		
D81271	900mm High x 900mm Dia.	



Large Breakout Bean Bag Chair Set of Six

Large Breakout Bean Bag Chair - Set of Six		
D81272	900mm High x 900mm Dia.	



Choice of bean bag fabric colours

LIME GREEN	CERISE PINK	ORANGE	RED	AQUA	ROYAL BLUE	NAVY
FOREST GREEN	YELLOW	PLUM	GREY	BROWN	SAND	BLACK





Square Floor Bean Cushions - Set of Eight



Square Floor Bean Cushions with Carry Handle - Set of Eight		
D81127	H120mm x W430mm x D430mm	

Including Storage Trolley

Square Deep Floor Bean Cushions Set of Eight with Trolley		
D81130	H450mm x W1120mm x D462mm	

Square Deep Bean Cushions - Set of Eight



Square Carry Handle Deep Floor Bean Cushions - Set of Eight		
D81128	H170mm x W300mm x D300mm	

Including Storage Trolley

Square Deep Floor Cushions Set of Eight with Trolley		
D81131	H450mm x W1120mm x D462mm	

Wide Deep Floor Bean Cushions - Set of Eight



Wide Deep Floor Bean Cushions with Carry Handle - Set of Eight		
D81129	H170mm x W400mm x D300mm	

Including Storage Trolley

Wide Deep Floor Cushions - Set of Eight with Trolley		
D81132	H450mm x W1120mm x D462mm	

acorn

Choice of bean bag fabric colours



Original Soft Bean Cushion - Set of Eight



Original Soft Bean Cushion - Set of Eight with Trolley



Original Soft Bean Cushion - Set of Eight with Trolley		
D81134	H450mm x W1120mm x D462mm	

Original Soft Floor Bean Cushion - Set of Eight		
D81133	H170mm x W430mm x D430mm	



Choice of bean bag fabric colours

LIME GREEN	CERISE PINK	ORANGE	RED	AQUA	ROYAL BLUE	NAVY
FOREST GREEN	YELLOW	PLUM	GREY	BROWN	SAND	BLACK



ACORN BEAN BAGS



Square Foam Seat Pad - Set of Twenty

- Made from comfortable, long lasting foam
- Suitable for use indoors outdoors
- Brilliant for group work & storytime
- Available in bright & modern colours
- Accompanying trolley is available for easy storage & transporting of the cushions

Square Foam Seat Pad - Set of Twenty With Trolley



Square Foam Seat Pad - Set of Twenty		
D81136	H50mm x W400mm x D400mm	



Square Foam Seat Pad - Set of Twenty with Trolley		
D81137	H450mm x W1120mm x D462mm	



- Made from comfortable, long lasting foam
- Suitable for use indoors outdoors
- Brilliant for group work & storytime
- Available in bright & modern colours
- Accompanying trolley is available for easy storage & transporting of the cushions



Circular Foam Seat Pad - Set of Twenty

Circular Foam Seat Pad - Set of Twenty with Trolley

Circular Foam Seat Pad - Set of Twenty		
D81142	50mm High x 400mm Dia.	



Circular Foam Seat Pad - Set of Twenty with Trolley		
D81143	H450mm x W1120mm x D462mm	





Set of Six Round Floor Pads with Carry Case



Round Foam Seat Pads - Set of Six with Carry Case		
D81229	50mm High x 400mm Dia.	



Set of Four Leaf Bean Bags

Set of Four Leaf Bean Bags (Brights)		
D81280	H320mm x W750mm x D480mm	



Choice of bean bag fabric colours

LIME GREEN	CERISE PINK	ORANGE	RED	AQUA	ROYAL BLUE	NAVY
FOREST GREEN	YELLOW	PLUM	GREY	BROWN	SAND	BLACK

Set of Six Square Floor Pads with Carry Case



Square Foam Seat Pad - Set of Six with Carry Case		
D81267	H50mm x W400mm x D400mm	





Acorn Naturals Soft Seating

Inspired by nature, the Acorn naturals range of soft seating is perfect for bringing the outside in. Choose from a selection of fun leaf shapes of our classroom favourite dots & cubes. Neutral & calming colours will look great in any space or environment. These bean bags are showerproof and suitable for outdoor use, so you can even take the classroom outside. Great for group working and encouraging collaboration, children will love using our Acorn naturals soft seating as part of their lesson or during breaktimes as a comfy relaxing seat. Fabrics feature an anti-bacterial coating & are stain resistant. Fitted with inner zip bag to prevent any bean loss over time.

Bean Cubes - Set of Four (Natural)



Bean Cubes - Set of Four (Naturals)		
D81264	H380mm x W380mm x D380mm	



Bean Pod Seats - Set of Four (Natural)



Bean Pod Seats - Set of Four (Naturals)		
D81265	200mm High x 380mm Dia.	



Set of Four Leaf Bean Bags (Natural)



Leaf Bean Pod Seats - Set of Four (Naturals)		
D81258	H320mm x W750mm x D380mm	



Set of Twelve Leaf Fibre Mats (Natural)



Set of Twelve Leaf Fibre Mats (Natural)		
D81259	H20mm x W750mm x D480mm	

Set of Four Leaf Foam Pads (Natural)

Set of Four Leaf Foam Floor Pads (Natural) - Below		
D81266	H50mm x W750mm x D480mm	





acorn

Acorn Primary soft seating is a range of fun, bright and creative soft seating shapes that can be used to build exciting learning and play areas.

Crafted in the UK and finished by hand. This range is sewn in our Cadet performance vinyl which is latex free, ultra durable and stain resistant. The seating can be easily wiped clean and features an anti-bacterial Acryltron protective coating.

This range is made from high density foam that holds its' shape. Great for creating breakout areas, reading corners or adding bright seating to a library area.

Choose from our matching sets or create your own soft seating bundle to build the perfect learning environment.

Available in a choice of 8 modern, hard-wearing & brightly coloured Vinyls.

All fabric choices are flame retardent to ignition source 5 and comply to BS5852 part 2.





Fabric Choices

Cadet Colour choices - the market leading vinyl upholstery range, feels even softer, works even harder and is available in a range of bright and bold colours. Suitable for healthcare & educational environments. Cadet Colours are fire retardant, protected by Acrylton for enhanced durability and shield plus antibacterial defence.



Cobalt Blue 104



Apple Zest 222

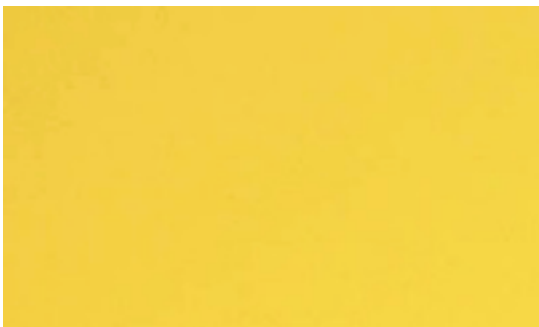

Lemon Zest 303



Tangerine Zest 438



Scarlet Red 440



Violet Zest 128

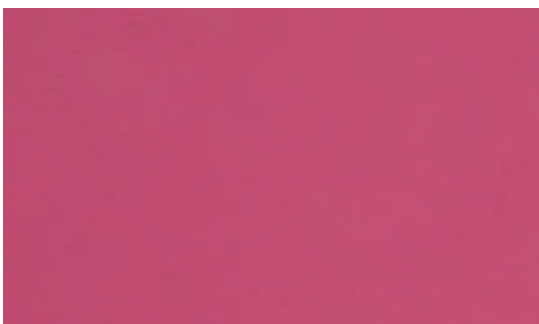

Fuschia 608



Turquoise 115



Mini Bite Foam Seats - Set of Six

Mini Bite Foam Seats - Set of Six	
D81058	350mm High x 350mm Dia.

- Interlocking bite design
- Can be used in a number of layouts
- Available in packs of 1, 4 or 6
- Great for reading corners or storytime
- Encourages collaborative work
- Anti-bacterial wipe clean vinyl



Mini Bite Foam Seats - Set of Four

Mini Bite Foam Seats - Set of Four	
D81057	350mm High x 350mm Dia.



Mini Bite Foam Seat

Mini Bite Foam Seat	
D81011	350mm High x 350mm Dia.





Fish Foam Seat

Fish Foam Seat		
D81034	H350mm x W790mm x D400mm	

- **Interlocking creative fish shape**
- Can be linked or used singularly
- Available in packs of 1, 4 or 6
- Creates a focal point in any room
- Encourages creativity & design
- Anti-bacterial wipe clean vinyl

Fish Foam Seats - Set of Four

Fish Foam Seats - Set of Four		
D81091	H350mm x W790mm x D400mm	



Fish Foam Seats - Set of Six

Fish Foam Seats - Set of Six		
D81092	H350mm x W790mm x D400mm	

Choice of vinyl seat colours

COBALT 104	TURQUOISE 115	VIOLET 128	APPLE 222	LEMON 303	TANGERINE 438	SCARLET 440	FUCHSIA 608





Mini Hexagon Foam Seat



Mini Hexagon Foam Seat	
D81033	350mm High x 350mm Dia:

Mini Hexagon Seats - Set of Three



Mini Hexagon Seats - Set of Three	
D81081	350mm High x 350mm Dia:

Mini Hexagon Seats - Set of Six



Mini Hexagon Seats - Set of Six	
D81082	350mm High x 350mm Dia:

- Honeycomb design
- **Create geometric shaped or linked curves**
- Available in packs of 1, 3 or 6
- **Can be used as a maths resource**
- Anti-bacterial wipe clean vinyl



Mini Dot Foam Seat



Mini Dot Foam Seat	
D81013	350mm High x 350mm Dia:

Mini Dot Foam Seats - Set of Four



Mini Dot Foam Seats - Set of Four	
D81086	350mm High x 350mm Dia:



- Simple circular dot shape
- Create collaborative circles or reading spaces
- Available in packs of 1, 4 or 6
- Compliments any space or reading corner
- Soft foam construction
- Anti-bacterial wipe clean vinyl

Mini Dot Foam Seats - Set of Six



Mini Dot Foam Seats - Set of Six	
D81085	350mm High x 350mm Dia:

Choice of vinyl seat colours

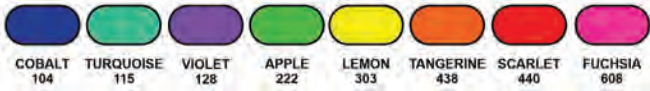



Dot Foam Seat



Dot Foam Seat	
D81013	350mm High x 350mm Dia:

- **Best selling range of soft seating**
- **Create shapes & styles of your own**
- **Link items together to create fun & inviting seating**
- **Available in a range of vibrant, modern colours**
- **Compliments any space or reading corner**
- **Soft foam construction**
- **Anti-bacterial wipe clean vinyl**

Double Bite Foam Seat



Double Bite Foam Seat	
D81015	350mm High x 350mm Dia:

Mini Bite Foam Seat



Mini Bite Foam Seat	
D81011	350mm High x 350mm Dia:



Choice of vinyl seat colours

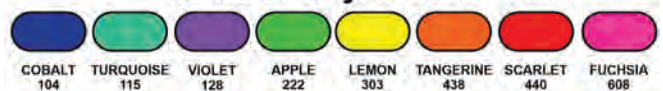

Dash Foam Seat



Dash Foam Seat		
D81012	H350mm x W710mm x D360mm	



Dot & Dash Foam Seat Set of 6		
D81279	H350mm x W710mm x D360mm	



Bow Foam Seat



Bow Foam Seat		
D81014	H350mm x W710mm x D360mm	

Choice of vinyl seat colours

COBALT 104	TURQUOISE 115	VIOLET 128	APPLE 222	LEMON 303	TANGERINE 438	SCARLET 440	FUCHSIA 608





Large Bite Foam Seat



Large Bite Foam Seat	
D81021	350mm High x 680mm Dia:



Large Bite Foam Seat - Set of Three



Large Bite Seat - Set of Three	
D81059	350mm High x 680mm Dia:

- Interlocking bite design
- Can be used in a number of layouts
- Works with other products in the Primary range
- Available in packs of 1 or 3
- Great for group work or collaboration
- Ideal for reading corners & story time circles
- Anti-bacterial wipe clean vinyl

Choice of vinyl seat colours

COBALT 104	TURQUOISE 115	VIOLET 128	APPLE 222	LEMON 303	TANGERINE 438	SCARLET 440	FUCHSIA 608

Single Petal Foam Seat



Single Petal Foam Seat		
D81022	H350mm x W720mm x D500mm	

Dot Foam Seat



Dot Foam Seat		
D81013	350mm High x 350mm Dia:	

Petal Set - Three Petals & Dot Seat



Petal Foam Seat - Set of Three & Dot		
D81061	H250mm x 1790mm Dia	

Petal Set - Four Petals & Dot Seat



Petal Foam Seat - Set of Four & Dot		
D81062	H250mm x 1790mm Dia	





Cube Foam Seat

Cube Foam Seats - Set of Four



Cube Foam Seat		
D81093	H350mm x W350mm x D350mm	

Cube Foam Seats - Set of Four		
D81063	H350mm x W350mm x D350mm	

Cube Foam Seats - Set of Six



Cube Foam Seats - Set of Six		
D81064	H350mm x W350mm x D350mm	

- Simple & sleek cube shape
- Lightweight & portable
- Available in packs of 1, 4 or 6
- Compliments any space or reading corner
- Soft foam construction
- Anti-bacterial wipe clean vinyl

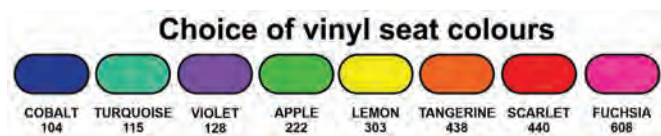

Flower Set - Five Petals & One Dot Seat



Flower Set - Five Petals & One Dot Seat	
D81069	350mm High x 1100mm Dia:



- **Fun & inviting design**
- **Encourages collaboration & group work**
- **Supplied as a set of 5 Petals & 1 Dot**
- **Adds a brilliant focal point to your space**
- **Centre piece can be used as a work surface**
- **Anti-bacterial wipe clean vinyl**



Petal Segment Set - Three Seats



Petal Segment Set	
D81068	350mm High x 740mm Dia.



Beam Foam Seat



Beam Foam Seat		
D81023	H350mm x W700mm x D350mm	

- Seats two children
- Build a run of seating or use individually
- Available in packs of 1, 3 or 5
- Perfect for reading areas
- Bright & modern colours
- Anti-bacterial wipe clean vinyl

Beam Foam Seats - Set of Five



Beam Foam Seats - Set of Five		
D81066	H350mm x W700mm x D350mm	

Beam Foam Seats - Set of Three



Beam Foam Seats - Set of Three		
D81065	H350mm x W700mm x D350mm	

Choice of vinyl seat colours

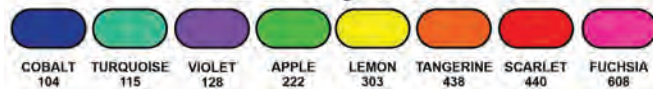



Large Square Foam Seat



- Seats multiple children at once
- Use as seating or as a play table
- Available in packs of 1, 3 or 6
- Combine to make a multicoloured island
- Soft foam construction
- Anti-bacterial wipe clean vinyl

Large Square Foam Seats - Set of Six



Large Square Foam Seat		
D81024	H350mm x W600mm x D600mm	

Large Square Foam Seats - Set of Six		
D81094	H350mm x W600mm x D600mm	

Large Square Foam Seats - Set of Three



Choice of vinyl seat colours

COBALT 104	TURQUOISE 115	VIOLET 128	APPLE 222	LEMON 303	TANGERINE 438	SCARLET 440	FUCHSIA 608

Large Square Foam Seats - Set of Three		
D81067	H350mm x W600mm x D600mm	





Hexagon Foam Seat



Hexagon Foam Seat		
D81026	H350mm x 585mm Dia.	

Hexagon Foam Seats - Set of Six



Hexagon Foam Seats - Set of Six		
D81070	H350mm x 585mm Dia.	

Hexagon Foam Seats - Set of Three



Hexagon Foam Seats - Set of Three		
D81071	H350mm x 585mm Dia.	

- Honeycomb linking design
- Link together or use singularly
- Create geometric patterns
- Available in packs of 1, 3 or 6
- Can be used as a maths resource
- Anti-bacterial wipe clean vinyl

Choice of vinyl seat colours

COBALT 104	TURQUOISE 115	VIOLET 128	APPLE 222	LEMON 303	TANGERINE 438	SCARLET 440	FUCHSIA 608

Wedge Foam Seat



Wedge Foam Seat		
D81027	H350mm x W540mm x D540mm	

Wedge Foam Seats - Set of Six



Wedge Foam Seats - Set of Six		
D81073	H350mm x W540mm x D540mm	

Wedge Foam Seats - Set of Three



Wedge Foam Seats - Set of Three		
D81072	H350mm x W540mm x D540mm	

- **Wedge design**
- **Link together or use singularly**
- **Ideal as a comfortable reading or story time seats**
- **Available in packs of 1, 3 or 6**
- **Combine with other products to create more complex shapes**
- **Anti-bacterial wipe clean vinyl**

Choice of vinyl seat colours

COBALT 104	TURQUOISE 115	VIOLET 128	APPLE 222	LEMON 303	TANGERINE 438	SCARLET 440	FUCHSIA 608





Small Curve Foam Seat



Small Curve Foam Seat		
D81028	H350mm x W650mm x D330mm	

Small Curve Foam Seats - Set of Four



Small Curve Foam Seats - Set of Four		
D81075	H350mm x W650mm x D330mm	

Small Curve Foam Seats - Set of Three



Small Curve Foam Seats - Set of Three		
D81074	H350mm x W650mm x D330mm	

- Short curved design
- Link together or use singularly
- Create reading circles or curves
- Available in packs of 1, 3 or 4
- Combine to make more complex shapes
- Anti-bacterial wipe clean vinyl

Choice of vinyl seat colours

COBALT 104	TURQUOISE 115	VIOLET 128	APPLE 222	LEMON 303	TANGERINE 438	SCARLET 440	FUCHSIA 608



Wave Foam Seat



Wave Foam Seat	
D81029	H350mm x W920mm x D440mm

- **Creates rows or islands of seating**
- **Link together or use singularly**
- **Combine to use as a seat & play surface**
- Available in packs of 1 or 3
- **Combine to make more complex shapes**
- **Anti-bacterial wipe clean vinyl**

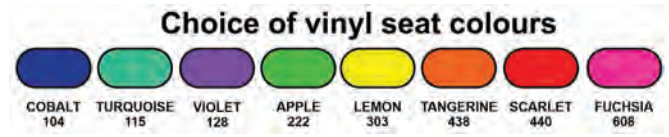

Wave Foam Seats - Set of Three



Wave Foam Seats - Set of Three	
D81076	H350mm x W920mm x D440mm





Trapezoidal Foam Seat



Trapezoidal Foam Seat		
D81030	H350mm x W650mm x D330mm	

- **Creates rows or islands of seating**
- **Link together or use singularly**
- **Combine to use as a seat & play surface**
- Available in packs of 1 or 3
- **Combine to make more complex shapes**
- **Anti-bacterial wipe clean vinyl**

Trapezoidal Foam Seats - Set of Three



Trapezoidal Foam Seats - Set of Three		
D81077	H350mm x W650mm x D330mm	

Choice of vinyl seat colours

COBALT 104	TURQUOISE 115	VIOLET 128	APPLE 222	LEMON 303	TANGERINE 438	SCARLET 440	FUCHSIA 608

Large Curve Foam Seat



Large Curve Foam Seat		
D81031	H350mm x W1000mm x D350mm	

Large Curve Foam Seats - Set of Three



Large Curve Foam Seats - Set of Three		
D81080	H350mm x W1000mm x D350mm	

Dot Foam Seat



Dot Foam Seat		
D81013	350mm High x 350mm Dia:	

- **Quarter curve design**
- **Link together or use singularly**
- **Create reading circles or curves**
- **Available in packs of 1 or 3**
- **Combine 3 seats & a dot seat to make the Acorn Campfire set (shown below)**
- **Anti-bacterial wipe clean vinyl**

Choice of vinyl seat colours

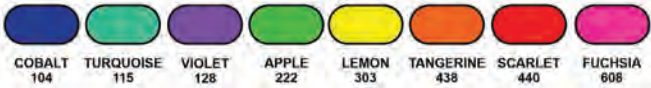



Large Dot Foam Seat



Large Dot Foam Seat	
D81153	350mm High x 600mm Dia:

Large Dot Foam Seat - Set of Three



Large Dot Foam Seat - Set of Three	
D81154	350mm High x 600mm Dia:

Large Dot Foam Seat - Set of Six



Large Dot Foam Seat - Set of Six	
D81155	350mm High x 600mm Dia:

- Circular seat seats multiple children
- Can be used in a number of layouts
- Works with products from the Primary range
- Available in packs of 1, 3 or 6
- Great for group work or story time circles
- Encourages collaborative work
- Anti-bacterial wipe clean vinyl





Mini Wedge Foam Seats - Set of Six



Mini Wedge Foam Seats - Set of Six		
D81146	H350mm x W350mm x D350mm	

Mini Wedge Foam Seat



Mini Wedge Foam Seat		
D81144	H350mm x W350mm x D350mm	

Mini Wedge Foam Seats - Set of Three



Mini Wedge Foam Seats - Set of Three		
D81145	H350mm x W350mm x D350mm	





- Modern cube & ellipse shapes
- Mix & match to create your own sets
- Attractive contrasting two tone design
- Double stitching detail
- Great for breakout areas
- Available in a range of sizes
- Anti-bacterial wipe clean vinyl

Two Tone Breakout Cube

Two Tone Breakout Cube		
D81017	H350mm x W450mm x D450mm	

Supplied in grey with a choice of colours on the facing panels.

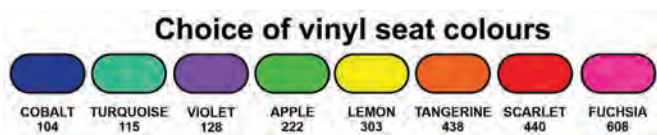

Two Tone Breakout Square

Two Tone Breakout Square		
D81018	H350mm x W900mm x D900mm	





Two Tone Breakout Ellipse

Two Tone Breakout Ellipse		
D81016	H350mm x W810mm x D450mm	

Two Tone Breakout Large Ellipse

Two Tone Breakout Large Ellipse		
D81019	H350mm x W1200mm x D450mm	



Two Tone Breakout Beam Seat

Two Tone Breakout Beam Seat		
D81020	H350mm x W900mm x D350mm	

Supplied in grey with a choice of colours on the facing panels.

Choice of vinyl seat colours

COBALT 104	TURQUOISE 115	VIOLET 128	APPLE 222	LEMON 303	TANGERINE 438	SCARLET 440	FUCHSIA 608



Arno Right Hand Modular Seat



Arno Right Hand Modular Seat		
D81206	H775mm x W610mm x D690mm	

Arno Left Hand Modular Seat



Arno Left Hand Modular Seat		
D81205	H775mm x W610mm x D690mm	

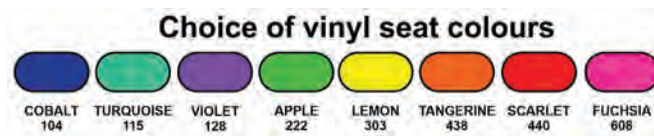

Arno Corner Modular Seat



Arno Corner Modular Seat		
D81207	H775mm x W690mm x D690mm	

Arno Single Modular Seat



Arno Single Modular Seat		
D81204	H775mm x W610mm x D690mm	





Arno Five Seat Large Corner Set

Arno Five Seat Large Corner Set		
D81268	H775mm x W1910mm x D1910mm	

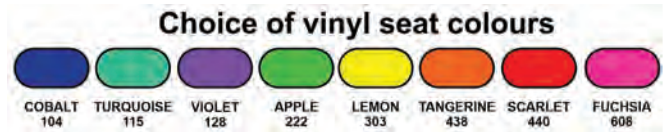

Arno Four Seat Corner Set



Arno Four Seat Corner Set		
D81269	H775mm x W1910mm x D1300mm	



Arno Three Seat Corner Set



Arno Three Seat Corner Set		
D81270	H775mm x W1300mm x D1300mm	



Garda

The new Acorn Garda Range has been designed to give an industrial yet relaxed feel to breakout and seating areas. Comfortable, yet robust and long lasting. Featuring a printed graffiti design seat top with a graphite border in a choice of 3 colourways. Make a statement with these bold prints and stylish, timeless shapes.

Mix and match to create a seating style that suits you. The tall boy cube can also be used as an armrest or working table for books and laptops. The Garda range uses modern angled polished chrome feet. Suitable for reception, lounge, and hospitality areas.

Downtown - 250 Green/Grey
Highland - 954 Graphite

Downtown - 949 Noir
Highland - 954 Graphite

Downtown - 105 Indigo
Highland - 105 Indigo

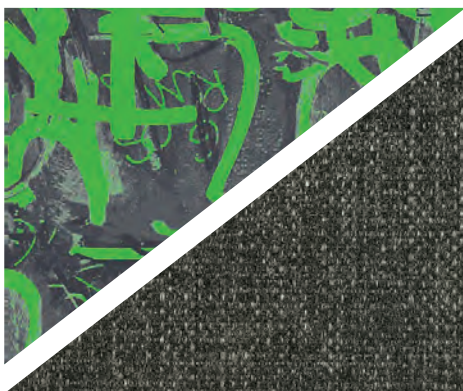



Garda Tall Boy Cube

H650mm x W450mm x D450mm

Ideal to use as an armrest or working table for books or a laptop.

Garda Tall Boy Cube	
D81157	



Garda Cube Seat

H450mm x W450mm x D450mm

Garda Cube Seat	
D81158	



ACORN SECONDARY SEATING

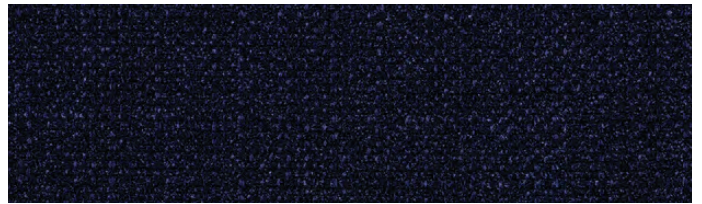
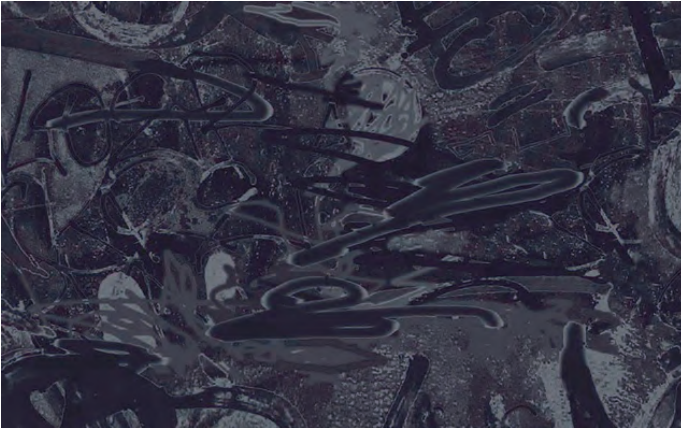



**Garda
900mm Beam Seat**

H450mm x W900mm x D450mm

Garda 900mm Beam Seat	
D81159	

**Garda
1200mm Beam Seat**

H450mm x W1200mm x D450mm

Garda 1200mm Beam Seat	
D81160	

**Garda
1500mm Beam Seat**

H450mm x W1500mm x D450mm

Garda 1500mm Beam Seat	
D81161	



Garda Round Stool

H450mm x 450mm Dia.

Garda Round Stool	
D81162	





Orta

The new Acorn Orta is an eye catching range of beam seating benches, plus cube & dot seats. Comfortable, yet robust and long lasting. Featuring a printed doodle design seat top with a graphite border in a choice of 3 colourways. Make a statement with these bold prints and stylish, timeless shapes. Mix and match to create a seating style that suits you. The tall boy cube can also be used as an armrest or working table for books and laptops. The Orta range uses modern angled polished chrome feet. Suitable for reception, lounge, and hospitality areas.



Rythm - 949 Noir
Highland - 954 Graphite

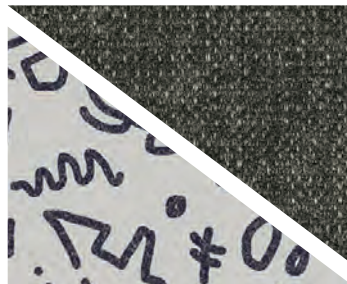

Rythm - 583 Grey/Stone
Highland - 954 Graphite



Rythm - 127 Lilac/Graphite
Highland - 954 Graphite



Rythm - 105 Indigo
Highland - 105 Indigo



Rythm - 583 Grey/Stone
Highland - 105 Indigo



Rythm - 127 Lilac/Graphite
Highland - 105 Indigo





Orta Cube Seat

H450mm x W450mm x D450mm

Orta Round Stool	
D81163	

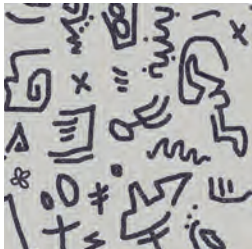

Orta Tall Boy Cube

H650mm x W450mm x D450mm

Orta Tall Boy Cube	
D81164	

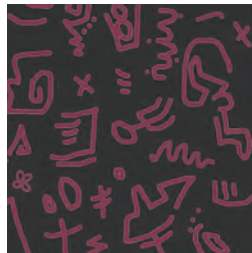
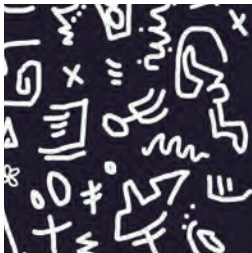



Orta Round Stool

H450mm x 450mm Dia.

Orta Round Stool	
D81165	



Rythm - 949 Noir
Highland - 954 Graphite

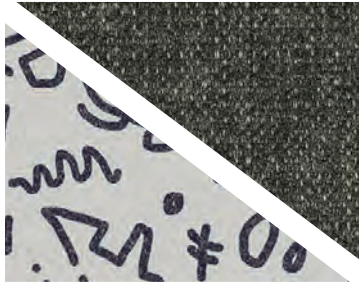

Rythm - 583 Grey/Stone
Highland - 954 Graphite



Rythm - 127 Lilac/Graphite
Highland - 954 Graphite



Rythm - 105 Indigo
Highland - 105 Indigo



Rythm - 583 Grey/Stone
Highland - 105 Indigo



Rythm - 127 Lilac/Graphite
Highland - 105 Indigo

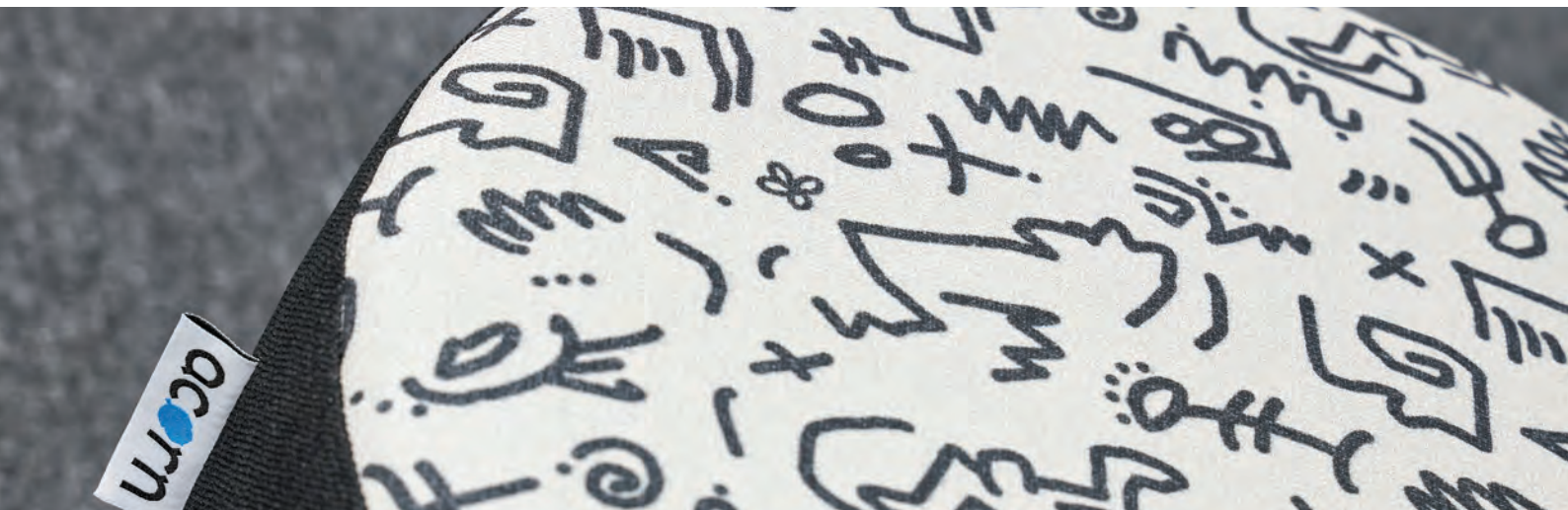



**Orta
900mm Beam Seat**

H450mm x W900mm x D450mm

Orta 900mm Beam Seat

D81166

**Orta
1200mm Beam Seat**

H450mm x W1200mm x D450mm

Orta 1200mm Beam Seat

D81167

**Orta
1500mm Beam Seat**

H450mm x W1500mm x D450mm

Orta 1500mm Beam Seat

D81168

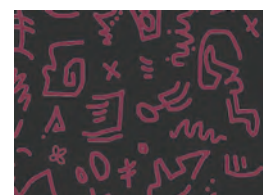
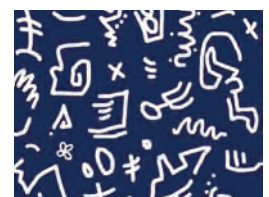
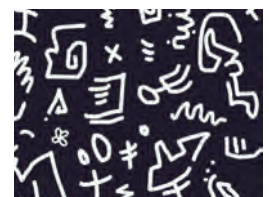
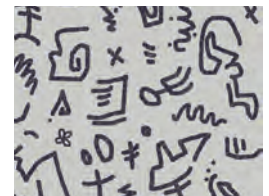



Como

The new Acorn Como range is of minimalist by design beam soft seating. A sleek look available in a range of colours to suit any environment. Comfortable yet robust, and generous in size. Made from the renowned and hardwearing Xtreme fabric group. Xtreme fabrics feature a modern crepe weave and are made from 100% recycled polyester, diverting waste from landfill and saving virgin raw materials. The Como range also features stylish angled polished chrome legs. Perfect for breakout, reception, lounge or hospitality areas. Combine multiple sizes to create a run or trail of seating.

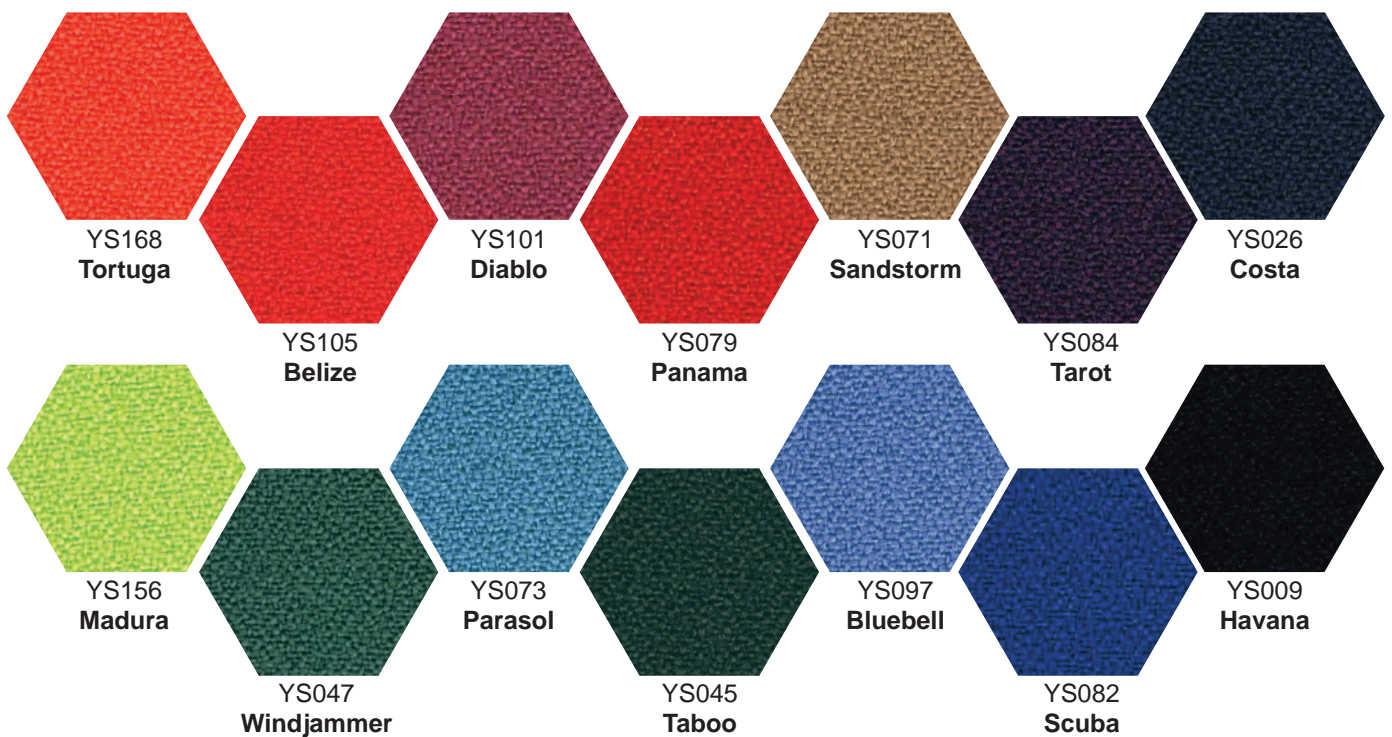

Como Cube Seat

H450mm x W450mm x D450mm

Como Cube Seat	
D81169	

Como 900mm Beam Seat

H450mm x W900mm x D450mm

Como 900mm Beam Seat	
D81170	

Como 1200mm Beam Seat

H450mm x W1200mm x D450mm

Como 1200mm Beam Seat	
D81171	

Como 1500mm Beam Seat

H450mm x W1500mm x D450mm

Como 1500mm Beam Seat	
D81172	



Como 1500mm bench shown above

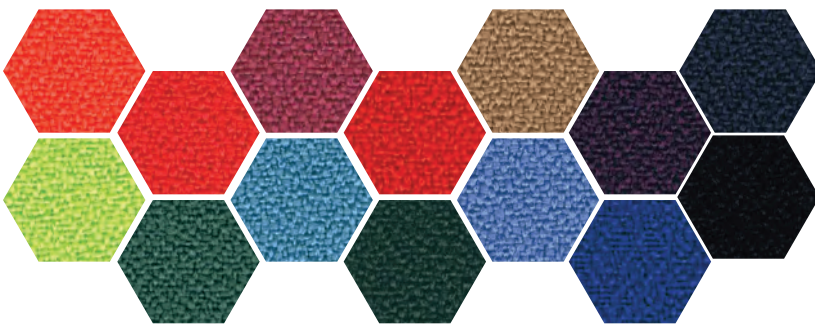



Lugano

The new Acorn Lugano is a range of contemporary beam soft seating. A sleek look available in a range of two tone colours to suit any environment. Comfortable yet robust, and generous in size. Made from the renowned and hardwearing Xtreme fabric group. Xtreme fabrics feature a modern crepe weave and are made from 100% recycled polyester, diverting waste from landfill and saving virgin raw materials. Featuring square corner polished chrome legs, these stand out peices will look great anywhere.

Perfect for breakout, reception, lounge or hospitality areas. Supplied in graphite with a choice of top colour for a contrast detail.

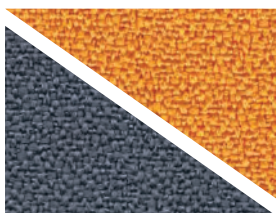

YS072 - Solano
YS171 - Osumi

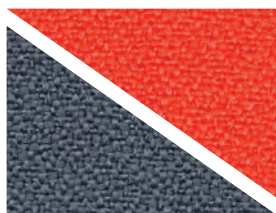

YS168 - Tortuga
YS171 - Osumi

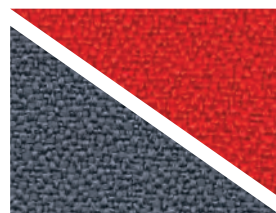

YS105 - Belize
YS171 - Osumi

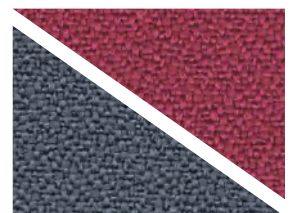

YS101 - Diablo
YS171 - Osumi

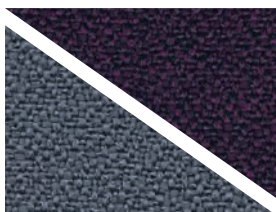

YS084 - Tarot
YS171 - Osumi

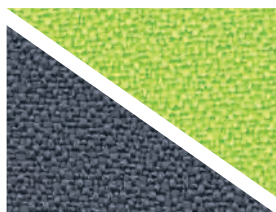

YS156 - Madura
YS171 - Osumi

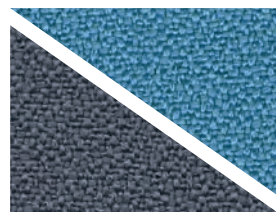

YS073 - Parasol
YS171 - Osumi

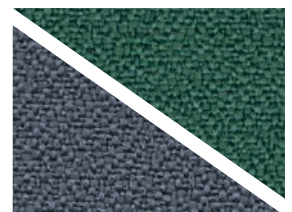

YS047 - Windjammer
YS171 - Osumi

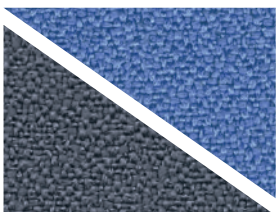

YS097 - Bluebell
YS171 - Osumi

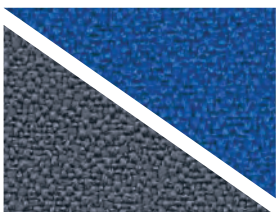

YS035 - Honeymoon
YS171 - Osumi

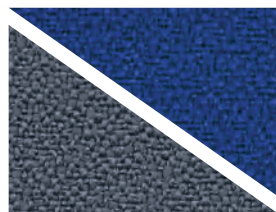

YS082 - Scuba
YS171 - Osumi

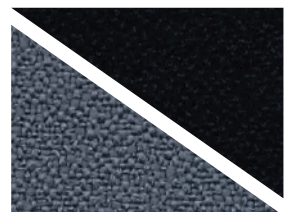

YS009 - Havana
YS171 - Osumi

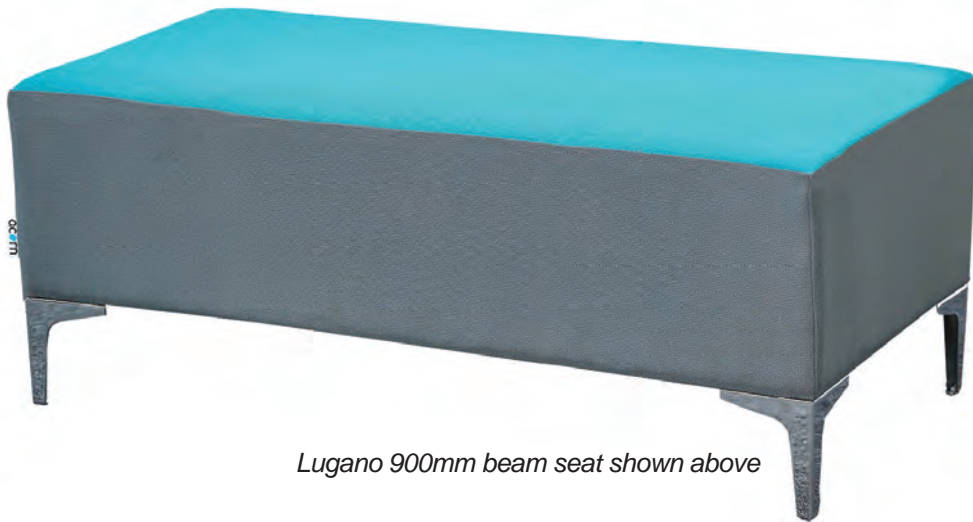

Lugano 900mm beam seat shown above

Lugano 900mm Beam Seat

H450mm x W900mm x D450mm

Lugano 900mm Beam Seat	
D81173	

Lugano 1200mm Beam Seat

H450mm x W1200mm x D450mm

Lugano 1200mm Beam Seat	
D81174	

Lugano 1500mm Beam Seat

H450mm x W1500mm x D450mm

Lugano 1500mm Beam Seat	
D81175	

Lugano Cube Seat

H450mm x W450mm x D450mm

Lugano Cube Seat	
D81176	

Lugano Square Seat

H450mm x W900mm x D900mm

Lugano Square Seat	
D81177	



Lugano 900mm x 900mm square seat shown above



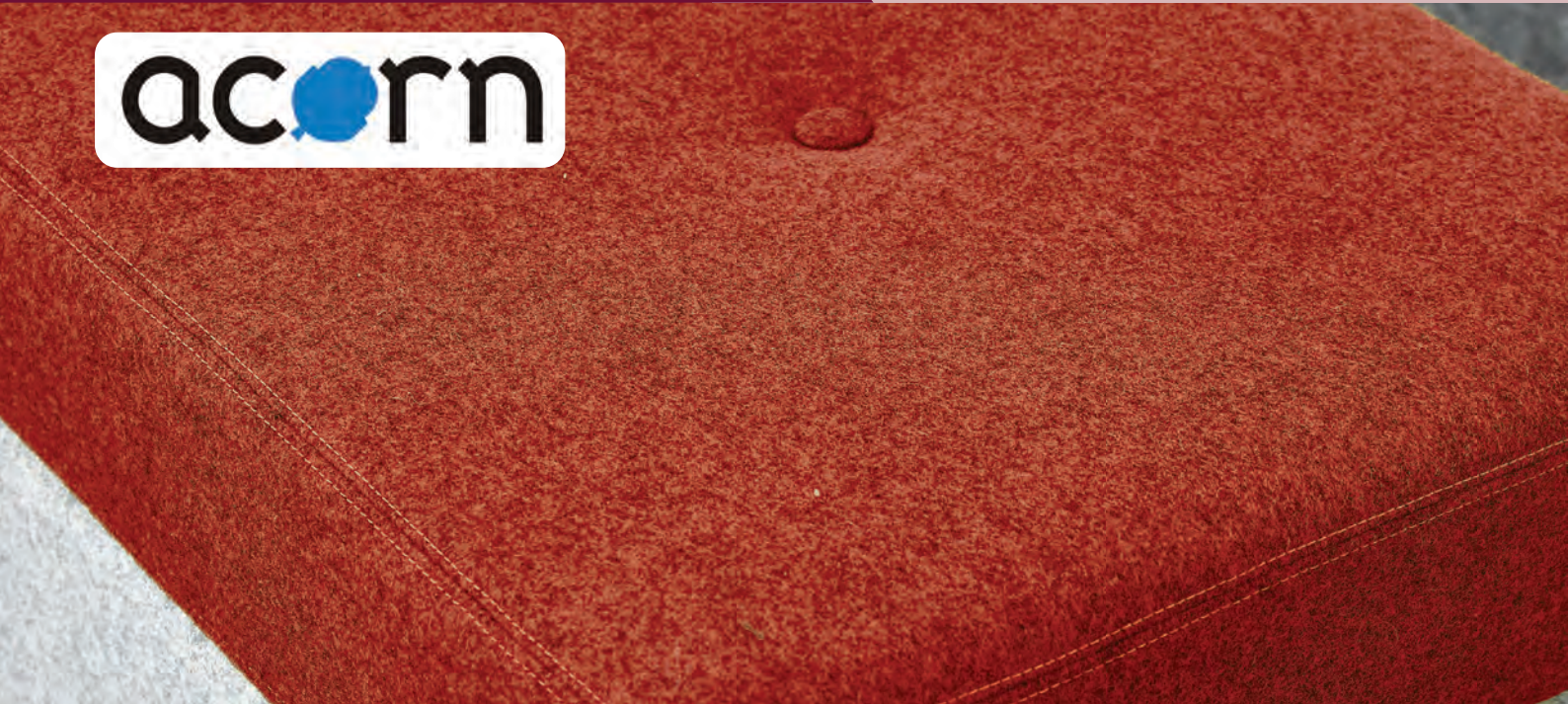

Segrino

The Acorn Segrino Range has been designed to make a statement whilst looking refined, inviting and professional. A sleek look available in a range of two tone colours to suit any environment. Comfortable yet robust, with a top cushion detail in a choice of bold colours. The top cushion features buttons details in matching fabrics and double stitching for even more finesse.

Upholstered in Camira Blazer which is a classic pure new wool fabric with a billiard cloth felted finish. Featuring square corner polished chrome legs, these stand out peices will look great anywhere. Perfect for breakout, reception, lounge or hospitality areas.

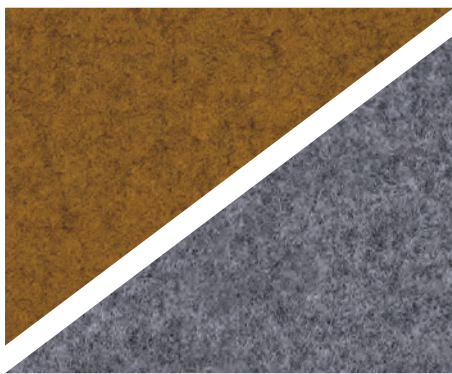

CUZ82 - Wesley
CUZ1E - Surrey

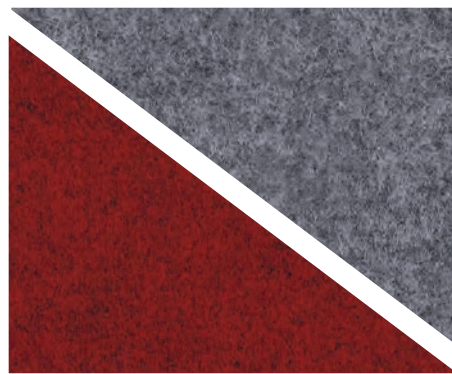

CUZ63 - Handcross
CUZ1E - Surrey

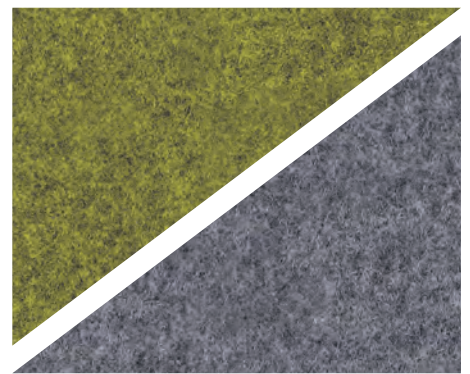

CUZ1F - Ulster
CUZ1E - Surrey

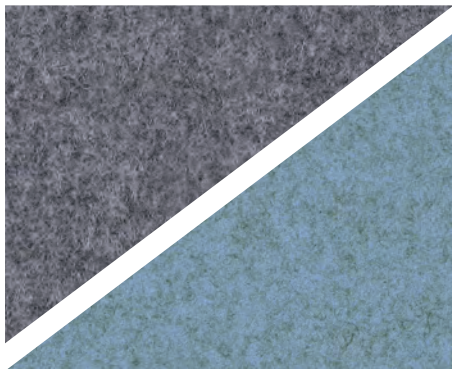

CUZ1R - Plymouth
CUZ1E - Surrey

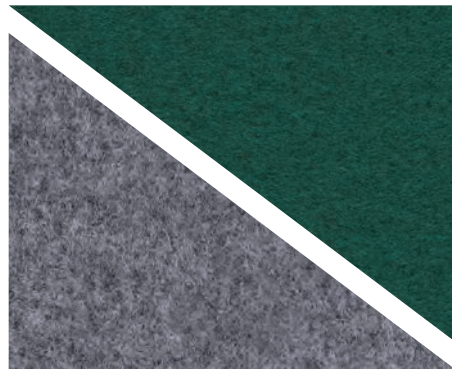

CUZ3B - Abertey
CUZ1E - Surrey

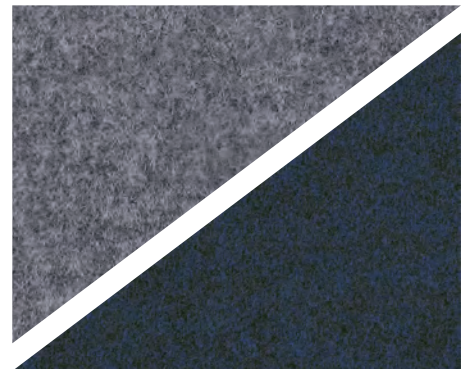

CUZIW - Newcastle
CUZ1E - Surrey

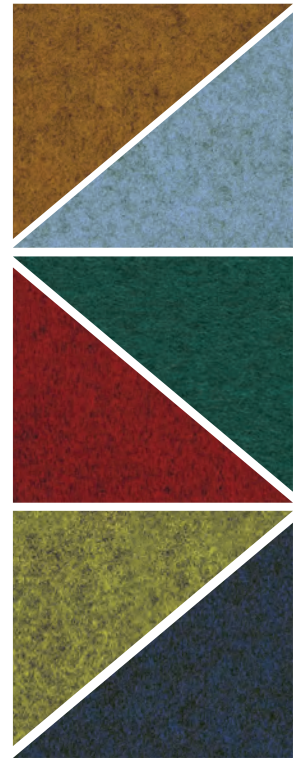

**Segrino
900mm Beam Seat**
H450mm x W900mm x D450mm

Segrino 900mm Beam Seat	
D81178	

**Segrino
1200mm Beam Seat**
H450mm x W1200mm x D450mm

Segrino 1200mm Beam Seat	
D81179	

**Segrino
1500mm Beam Seat**
H450mm x W1500mm x D450mm

Segrino 1500mm Beam Seat	
D81180	

Segrino Cube Seat
H450mm x W450mm x D450mm

Segrino 900mm Cube Seat	
D81181	

Segrino Square Seat
H450mm x W900mm x D900mm

Segrino Large Square Seat	
D81191	





Nemi

The Acorn Nemi Range is a classic range of low reception soft seating. Welcoming and comfortable with a soft foam seat. Combine multiple units to create a long multi seat sofa. Made from the renowned and hardwearing Xtreme fabric group. Xtreme fabrics feature a modern crepe weave and are made from 100% recycled polyester, diverting waste from landfill and saving virgin raw materials. The Nemi range comes in a wide range of colours to suit any setting.

A matching upholstered coffee table is also available in the range to complete the look. Perfect for breakout, reception, lounge or hospitality areas.

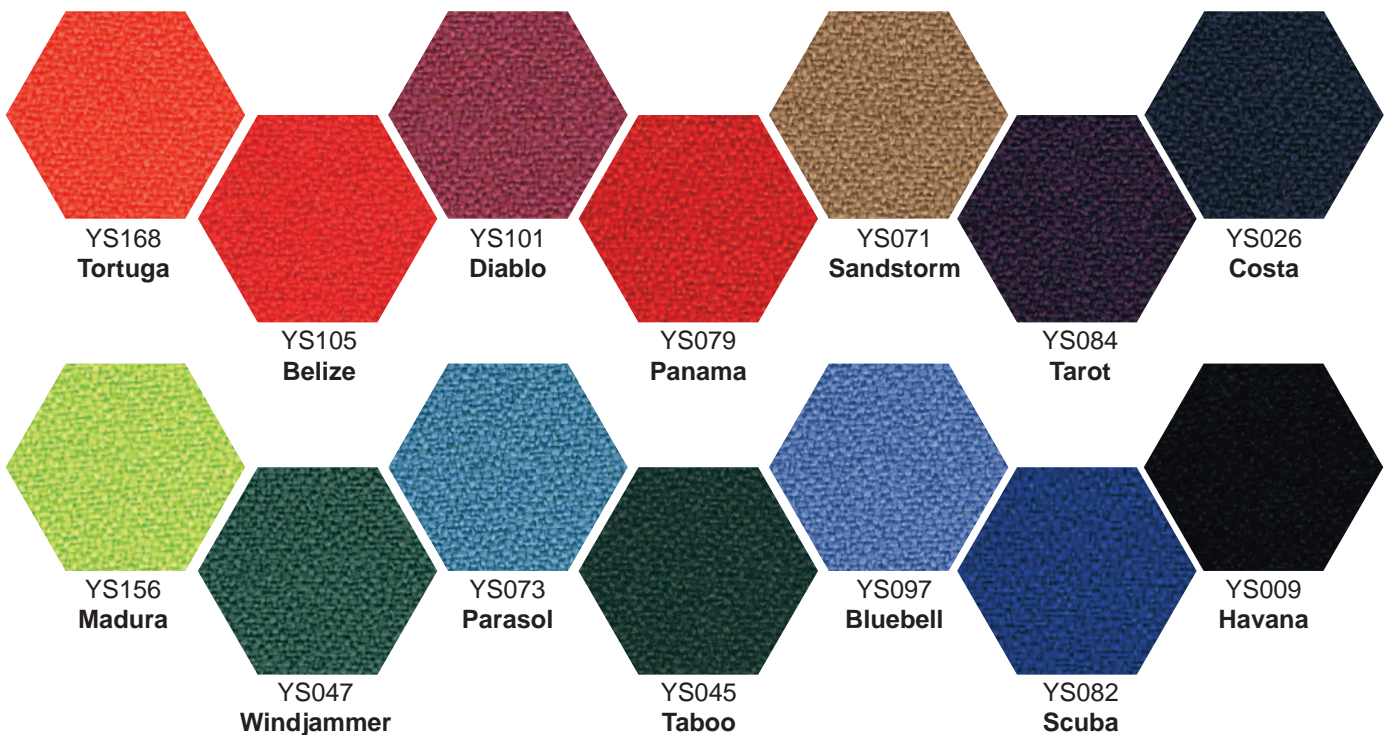

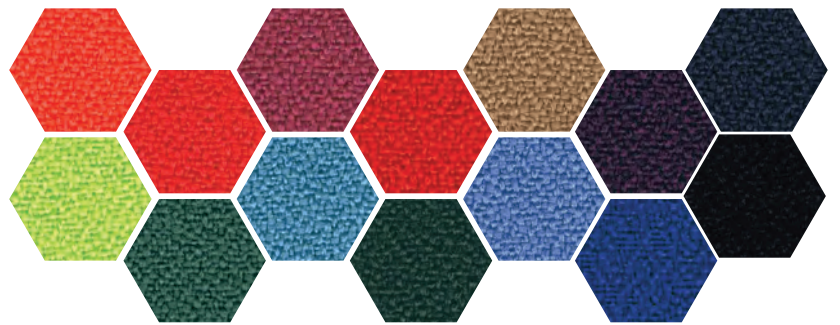

Nemi Seat without Arms

H775mm x W610mm x D690mm

Nemi Seat without Arms	
D81182	



Nemi Armchair

H775mm x W870mm x D690mm

Nemi Armchair	
D81183	



Nemi Right Arm Seat

H755mm x W740mm x D690mm

Nemi Right Arm Seat	
D81184	



Nemi Coffee Table

H370mm x W620mm x D620mm

Nemi Coffee Table	
D81185	



Nemi Left Arm Seat

H755mm x W740mm x D690mm

Nemi Left Arm Seat	
D81186	

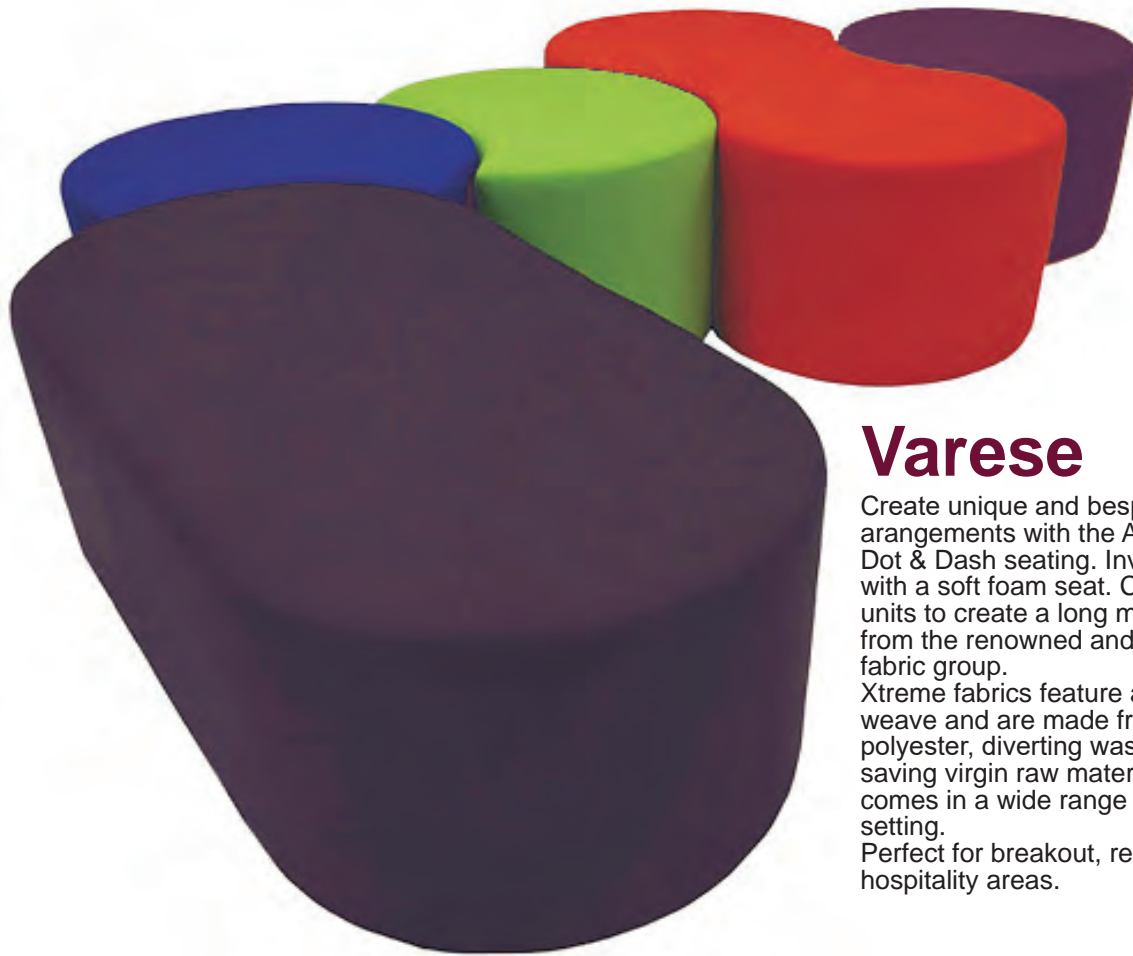

Varese

Create unique and bespoke seating arrangements with the Acorn Varese modular Dot & Dash seating. Inviting and comfortable with a soft foam seat. Combine multiple units to create a long multi seat sofa. Made from the renowned and hardwearing Xtreme fabric group.

Xtreme fabrics feature a modern crepe weave and are made from 100% recycled polyester, diverting waste from landfill and saving virgin raw materials. the Varese range comes in a wide range of colours to suit any setting.

Perfect for breakout, reception, lounge or hospitality areas.

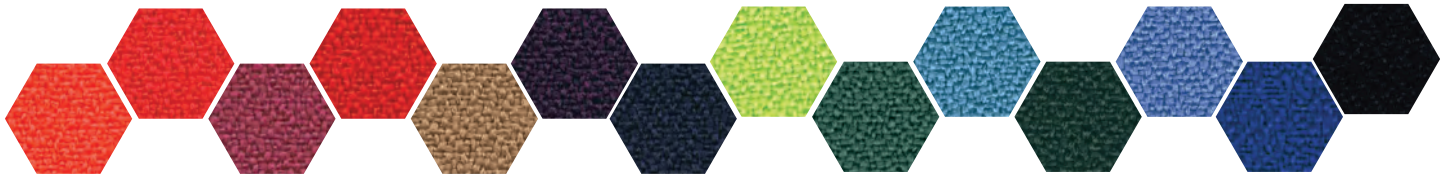

Varese Bow Dash Seat

H450mm x W1200mm x D600mm

Varese Bow Dash Seat	
D81188	

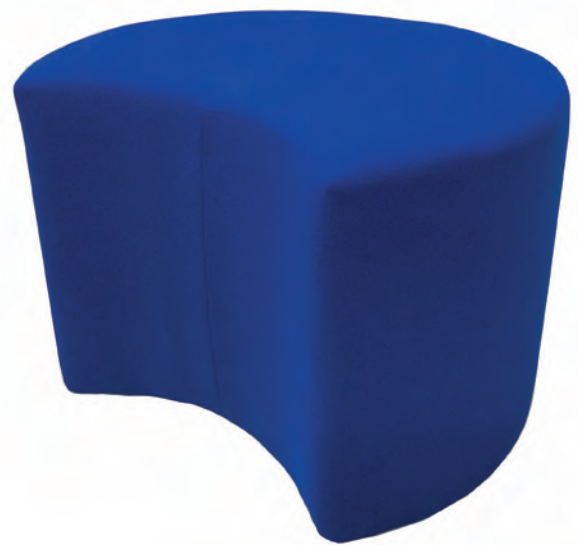

Varese Bite Dot Seat

H450mm x 600mm Dia.

Varese Bite Dot Seat	
D81187	

Varese Dash Seat

H450mm x W1200mm x D600mm

Varese Dash Seat	
D81189	



Varese Dot Seat

H450mm x 600mm Dia.

Varese Dot Seat	
D81190	

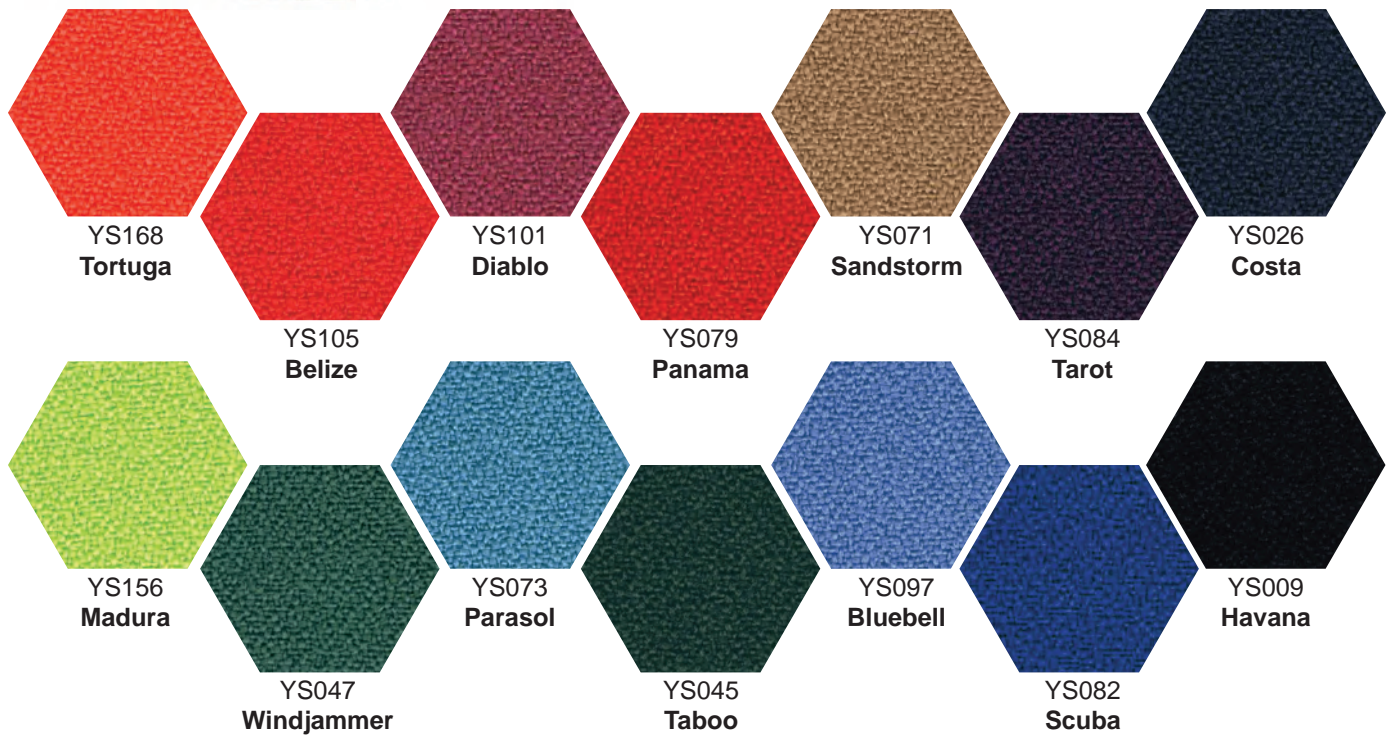

Valentine Beam Seating

Upholstered in XtremePlus Fabrics - other colours/fabrics can be made to order



Valentine 900mm Beam Seat
H450mm x W900mm x D450mm

Valentine 900mm Beam Seat	
D81237	



Valentine 1200mm Beam Seat
H450mm x W1200mm x D450mm

Valentine 1200mm Beam Seat	
D81238	



Valentine 1500mm Beam Seat
H450mm x W1500mm x D450mm

Valentine 1500mm Beam Seat	
D81239	



Valentine 900mm Square Seat
H450mm x W900mm x D900mm

Valentine 900mm Beam Seat	
D81242	



Valentine 450mm Cube Seat
H450mm x W450mm x D450mm

Valentine 1200mm Beam Seat	
D81236	



Valentine 450mm Tall Boy
H650mm x W450mm x D450mm

Valentine 1500mm Beam Seat	
D81241	

Valentine Dot & Dash Seating



Valentine Dot & Dash Set

Valentine Dot & Dash Set	
D81257	



Valentine Dot Seat
H450mm x 600mm Dia.

Valentine Dot Seat	
D81235	



Valentine fabric colour range

Tortuga	Belize	Panama	
Madura	Windjammer	Parasol	
Diablo	Sandstorm	Tarot	Costa
Taboo	BlueBell	Scuba	Havana

Upholstered in XtremePlus Fabrics - other colours/fabrics can be made to order



Valentine Coffee Table
H370mm x W620mm x D620mm

Valentine Coffee Table	
D81247	



Valentine Range
Premium Secondary & Adult Seating



Valentine Armchair
H775mm x W870mm x D690mm

Valentine Armchair	
D81246	



Valentine Right Arm Seat
H775mm x W740mm x D690mm

Valentine Right Arm Seat	
D81244	



Valentine Seat Without Arms
H775mm x W610mm x D450mm

Valentine Seat Without Arms	
D81243	



Valentine Left Arm Seat
H775mm x W740mm x D690mm

Valentine Left Arm Seat	
D81245	

Upholstered in XtremePlus Fabrics - other colours/fabrics can be made to order



Valentine Bite Seat
H450mm x 600mm Dia.

Valentine Bite Seat	
D81233	



Valentine Bow Dash Seat
H450mm x W900mm x D600mm

Valentine Bow Dash Seat	
D81232	



Valentine Dash Seat
H450mm x W1200mm x D600mm

Valentine Dash Seat	
D81234	



Jolly Back Chair

Innovative, low, mobile chair with height adjustable back rest and cushioned wedged seat support. Promotes natural upright posture and reduces awkward bending, twisting and kneeling - all hazardous daily activities of working in early years and primary! Physiotherapist designed.

Large and Medium height chairs are fitted with quality lockable castors for easy, smooth movement when sitting or standing.

Compact for use in limited spaces, features a comfy cushioned seat and tall backrest handle for safe moving - no more hazardous lifting chairs over children's' heads. Teachers can remain seated at child height to engage learners and children don't overstrain their necks by looking too high up (which often happens when teacher's use standard adult height furniture during floor/circle time).

Our Small chair is fitted with non-scratching glides to give posture and health benefits of the wedge seat and adjustable back rest, without the wheels.

Can be used at KS1 and KS2 tables. Weight tested to 110kg/17.3 stone. Warranty 3 years. 3 heights available.



Adult User Height	Pupil Age Range (user mostly working with)		
	Early Years (2-5 yrs)	Key Stage 1 (5-7 yrs)	Key Stage 2 (7-11 yrs)
5'3" and under	Small / Medium	Medium	Medium
5'4"	Small / Medium	Medium	Medium
5'5"	Small / Medium	Medium	Medium / Large
5'6"	Medium	Medium / Large	Large
5'7"	Medium	Large	Large
5'8" and over	Large	Large	Large

Jolly Back Chair with Castors



Jolly Back Chair with Castors		
JB0014/MED	Medium	£195.00
JB0014/LG	Large	£195.00

Choice of fabric colours

Water-resistant, wipeable and breathable fabric



Choice of vinyl colours

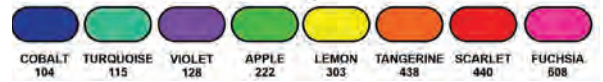

Jolly Back Chair with Glides



Jolly Back Chair with Glides		
JB0014/SM	Small	£195.00



NB: The Large Jolly Back chair is in Cobalt and glides are in Royal Blue.





Jolly Back Adult Floor Chair

H500mm x W390mm x D500mm

Jolly Back Junior Floor Chair

H400mm x W390mm x D500mm



Adult Floor Chair	
JB0010	

Junior Floor Chair	
JB0011	

Choice of fabric cushion colours



Comfortable back support when sitting on the floor. Compact, lightweight and non-tip back design for use indoors and out.

Our posture promoting floor chair features a carry handle to aid use on the go. Complete with removeable seat and back rest cushions, which are upholstered in durable, indoor and outdoor safe fabric. Seat safely raised to reduce finger trapping risk. Supports 1-1 and group floor level learning.

Designed for educators and children!



Jolly Back Maxi with Trolley

H760mm x W485mm x D485mm



Maxi Wedge Single Colour - Set of 12 plus Trolley
JB004/12/TR



Maxi Wedge

Multipurpose posture wedge to improve sitting or lying on the floor. Sit naturally upright when working with children and use to stretch out at the end of the day.

Lightweight and portable with removable, washable cover. Can also be used to give simple, effective spine support when sitting on a classroom or dining chair. Ideal for classrooms, outdoor learning, in staffrooms and when home working. Non-slip base.

Jolly Back Maxi Wedge - Set of 12

H20-75mm x W350mm x D280mm



Maxi Wedge - Set of 12 Single Colour
JB004/12



Our multi-use Maxi wedge can also be used by children to encourage active sitting, concentration, healthy spine development, for tummy-time play and as part of a soft, safe construction kit!



Available with a space saving, accessible trolley.

Choice of fabric colours



Jolly Back Maxi Wedge - 12 Naturals

H20-75mm x W350mm x D280mm



Maxi Wedge - Set of 12 Naturals
JB004/NAT

Jolly Back Maxi Wedge 12 Naturals with Trolley

H760mm x W485mm x D485mm

Maxi Wedge - Set of 12 Naturals with Trolley
JB004/NAT/TR

Jolly Back Maxi Wedge - 12 Brights

H20-75mm x W350mm x D280mm



Maxi Wedge - Set of 12 Brights
JB004/BR1

Jolly Back Maxi Wedge 12 Brights with Trolley

H760mm x W485mm x D485mm

Maxi Wedge - Set of 12 Brights with Trolley
JB004/BR1/TR



Sit & Lean Beanbag

H470mm x W410mm x D520mm

Clever use of beans as a posture promoting seat which doubles up as a back rest to lean on! Flexible and lightweight - ideal for agile learning and working environments. Can be used by adults and children in classrooms, reading areas, assembly halls and outside. A versatile, grab and go seating and back support option. Non slip base, carry handle and Velcro secure flap tidy



Sit & Lean Bean Bag	
JB0012	



Choice of fabric colours



Sit & Lean Block

H410mm x W410mm x D520mm

Supportive foam wedge seat which doubles up as a back support! Adaptable, lightweight and safe for flexible learning and working environments.

Can be used by adults and children in numerous settings - classrooms, outside, libraries, halls and as quick additional seating in staff rooms, breakout spaces, reception areas, meeting and therapy rooms.

Sit & Lean Block	
JB0013	



Lockable PosturePerch

H450mm x W450mm x D466mm

Mobile, multi-function stool with key lockable storage cupboard and removable wedge seat cushion, which doubles as a floor sitting support!

Quality castors for easy and smooth movement. Teachers can safely and securely store personal belongings and any medications out of childrens reach. A clever concept in seating and essential storage!

Weight tested to 110kg/17.3 stone.

Jolly Back Lockable PosturePerch	
JB0017	



LOCKABLE CASTORS



LOCKABLE CASTORS

Storage PosturePerch

H450mm x W366mm x D466mm

Mobile, multi-function, space efficient stool complete with 3 Gratnells trays and removable slim fit wedge seat cushion which doubles up as a floor sitting support!

Quality castors for easy and smooth movement. A clever concept in seating and essential storage!

Weight tested to 110kg/17.3 stone.

Storage PosturePerch	
JB0018	



Choice of fabric colours



Storage PostureBench

H450mm x W710mm x D466mm

Mobile, multi-function bench complete with 6 Gratnells trays and removable long wedge seat cushion which doubles up as a floor sitting support!

Quality castors for easy and smooth movement. A clever concept in seating and essential storage!

Weight tested to 110kg/17.3 stone.

Storage PostureBench	
JB0019	



LOCKABLE CASTORS

JOLLY BACK DUO WEDGE



Jolly Back Duo Wedge

H30-85mm x W800mm x D350mm

Multipurpose long posture supporting wedge for use when sitting on the floor. Sit comfortably upright, with space when working with children.

Can also be used by children for sitting and lying or as part of a safe, soft block construction set! Ideal for gross motor skills, physical activity and creative development.

Available with a space saving, accessible storage trolley.

Supports teaching and learning indoors and out!



H30-85mm x W800mm x D350mm

Duo Wedge Set of 6 - Single Colour

JB007/6	
---------	--



H400mm x W800mm x D460mm

Duo Wedge Set of 6 Single Colour with trolley

JB007/6/TR	
------------	--

Choice of fabric cushion colours



H30-85mm x W800mm x D350mm

Duo Wedge Set of 6 - Brights

JB007/BR	
----------	--



H400mm x W800mm x D460mm

Duo Wedge Set of 6 Brights with trolley

JB007/BR/TR	
-------------	--





H30-85mm x W800mm x D350mm

Duo Wedge Set of 6 - Naturals	
JB007/NAT	

H400mm x W800mm x D460mm

Duo Wedge Set of 6 Naturals with trolley	
JB007/NAT/TR	



Jolly Back Duo Wedge - Naturals

H30-85mm x W800mm x D350mm

Available in a wide range of bright & modern colours. Choose from packs of single colours, Brights and Naturals. Select a Bright pack to make a statement or Naturals pack for calmer areas.

Lightweight and portable with removable, washable cover.

Storage trolley is fitted with heavy duty smooth rolling castors and comes in a naturally finished look with tactile real wood posts.

Choice of fabric cushion colours





Kneel Friendly Mats

Our unique, bean filled play and floor mats have been designed with knees in mind! Cushioned edging provides a welcome relief to adult knees whilst maintaining a spacious play and learning area for children.

Fabric centre enabling mats to be moved and stored easily - indoors and out. Perfect to create a mini-contained soft construction area for creative and gross motor play when combined with our other posture cushions too!

Available in two sizes, Midi & Maxi.



Choice of fabric colours



Kneel Friendly Mats - Midi

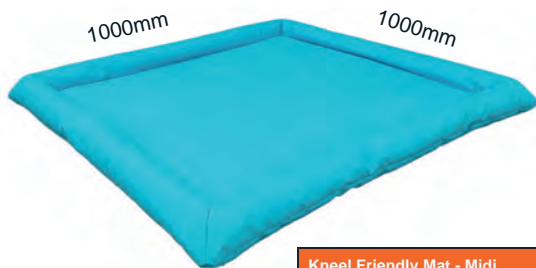

Kneel Friendly Mat - Midi	
JB0029	

Kneel Friendly Mats - Maxi



Kneel Friendly Mat - Maxi	
JB0028	





Jolly Back Mini Wedge

Multi-use, infant and child sized posture wedge for use when sitting or lying on the floor. Lightweight, stable and portable with removable, washable cover. Helps improve comfort and concentration and gives a sense of "own space". Can also be used to give effective spine support when sitting on "child-sized" chairs. Non-slip base.

Create an obstacle course or soft block construction kit with our other posture cushions, rolls and play mats for versatile fun, imagination and physical development!

Ideal for use indoors and out. Stackable in space-saving trolley available.



Choice of fabric cushion colours



Wedge - Set of 12 Naturals

H20-75mm x W280mm x D280mm

Mini Wedge - Set of 12 Naturals

JB0001/NAT

Set of 12 Single Colour

H20-75mm x W280mm x D280mm

Mini Wedge - Set of 12 Single Colour

JB0001/12

Wedge - Set of 12 Brights

H20-75mm x W280mm x D280mm

Mini Wedge - Set of 12 Brights

JB0001/BRI

Wedge - Set of 12 Naturals with trolley

H650mm x W400mm x D400mm

Mini Wedge - Set of 12 Naturals

JB0001/NAT/TR

Set of 12 Single Colour with trolley

H650mm x W400mm x D400mm

Mini Wedge - Set of 12 Single Colour

JB0001/12/TR

Wedge - Set of 12 Brights with trolley

H650mm x W400mm x D400mm

Mini Wedge - Set of 12 Brights

JB0001/BRI/TR





Jolly Back Bean Wedge

Posture supporting and calming wedge for sitting and lying on the floor. A perfect addition to reading areas, cosy nooks or quiet spaces, Beans mould to offer children a sense of reassuring calm, Complements flexible learning spaces and can be used indoor and out.



Jolly Back Bean Wedge

H220mm x W540mm x D540mm

Bean Wedge	
JB0030	

Jolly Back Wedge - Set of 2

H220mm x W540mm x D540mm

Bean Wedge - Set of 2	
JB0030/2	

Choice of fabric cushion colours



ALSO GREAT TO USE WITH OUR KNEE-FRIENDLY FLOOR MATS

Jolly Back Tummy Time Mirror

H230mm x W380mm x D170mm

Quality, safe freestanding mirror with hide and seek compartment and functional carry handle. Mirror can be used at 2 angles to encourage physical and healthy spine development in lying or sitting. Tummy time play builds strength, muscle control and coordination required for crawling and other gross motor activities. It is an essential part of child development.



Tummy Time Mirror

Tummy Time Mirror	
JB0031	

Tummy Time Mirror - 2 Pack

Tummy Time Mirror	
JB0031/2	

Jolly Back Pull Up Table

Lightweight, quick pull up wooden table for use in classrooms, reception areas, meeting rooms and staff rooms.

Compact size and practical for laptops and A4 sized books. Ideal to use when marking, planning and taking notes whilst helping to support good posture.



Jolly Back Pull Up Table

H640mm x W480mm x D450mm

Pull Up Table

JB0024



Jolly Back®



Portable Posture Roll

Handy back-saving cushion. Designed to fit snugly in the lower back. Offers lumbar support to improve back and neck posture.

Good spinal alignment lets back muscles relax. Posture rolls have been clinically proven to reduce back and associated neck pain.

Can be used to improve posture and comfort when using soft seating in the staff room, on hard classroom chairs and some office chairs. As an added benefit, can make driving and home working more comfortable.

A very versatile cushion to help look after staff!



Portable Posture Roll

380mm Long x 100mm Dia.

Pack of 4 Brights

Portable Posture Roll - Pack of 4 Brights	
JB0025/4/BRI	

Pack of 8 Brights

Portable Posture Roll - Pack of 8 Brights	
JB0025/8/BRI	

Pack of 4 Naturals

Portable Posture Roll - Pack of 4 Naturals	
JB0025/4/NAT	

Pack of 8 Naturals

Portable Posture Roll - Pack of 8 Naturals	
JB0025/8/NAT	

Pack of 4 Single Colour

Portable Posture Roll - Pack of 4 Single Colour	
JB0025/4	

Pack of 8 Single Colour

Portable Posture Roll - Pack of 8 Single Colour	
JB0025/8	



Long Bean Roll

800mm Length x 100mm Dia.

Versatile and effective roll to support spine health and physical development.

Can be used as a back relief for adults, a floor balance beam for children, part of an obstacle course, a quick area divider or a tummy time prop for infants!

Indoor and out use.

Set of 4 Brights

Long Bean Roll - Set of 4 Brights	
JB0026/4/BRI	

Set of 4 Naturals

Long Bean Roll - Set of 4 Naturals	
JB0026/4/NAT	

Set of 4 Single Colour

Long Bean Roll - Set of 4 Single Colour	
JB0026/4	

Choice of fabric colours





Mobile Teachers Station

Mobile, multi-function standing desk with key lockable storage cupboard and handy "keep safe" stationery tray! Quality castors for easy and smooth movement.

Height adjustable shelf for versatile storage options. Designed with the added benefit of 2 dry wipe white boards for adult and child use! Teachers can safely and securely store personal belongings and any medications out of children's reach. A clever concept in safe "posture promoting" furniture - improves working and learning environment with essential storage!

Available in 2 heights for users over and under 5ft3.

H950mm x W600mm x D500mm

H1050mm x W600mm x D500mm

Mobile Teachers Station - 950mm High	
JB0032	

Mobile Teachers Station - 1050mm High	
JB0033	



Ultimate Teachers Trolley

Designed with ergonomics and stationery in mind! With compartments and pockets, the opportunities for self-organisation and time-saving storage are limitless!

Height adjustable retractable handle, stable and durable. Easily move books, pens, cables and all you need between work and home and between rooms at work - all whilst limiting lifting and looking after your back.

NB. If lifting in/out of your car - place heavy books in separate bags to limit a single awkward lift.

H320mm x W350mm x D320mm

Ultimate Teachers Trolley	
JB0027	





Sit Stand Buddy

H300mm x W540mm x D400mm

A multifunctional and innovative low stool (with removable seat wedge cushion) which also doubles up as a standing desktop!

Sit comfortably at child height on the stool, be supported sitting on the floor and also work upright in standing.

A truly versatile piece of "posture-supporting" furniture.

Can be used indoors and out.
Non-Slip cushion base.

Sit Stand Buddy	
JB0023	

Choice of fabric colours



Low Floor Table

H300mm x W540mm x D400mm

Ergonomically designed low table with built in writing slope to aid good posture. Ideally suited to working at floor level indoors and out. Can be used by adults and children and fits over most laps. Suitable for use in staffrooms as a handy writing space and mini desk when using soft seating (such as a sofa).



Low Floor Table	
JB0022	





Ergo+ Petite Office Chair

The ultimate small office chair, compact ergonomic design with lockable castors for use in classrooms, staffrooms and offices. Fitted with a seat tilt to enable movement and correct hip and spine alignment. Inflatable lumbar support to give individual back comfort, right where it is needed. Complies with HSE's "Seating at Work" Guidance and helps employers meet Health and Safety (Display Screen Equipment) Regulations. Suitable for users approx 5'4" and under as their main office/desk chair and for taller users who require a height adjustable, small swivel chair for occasional use.

Weight tested 150kg/23 stone. Warranty 5 years.

Ergo+ Petite Office Chair	
JB0020	



Upholstered in XtremePlus Fabrics
Other colours/fabrics can be made to order

Tortuga	Belize	Diablo	Panama	Tarot	Costa	Madura
Parasol	Taboo	Bluebell	Scuba	Havana	Sand Storm	Wind Jammer



Ergo+ Office Chair

The ultimate office chair, ergonomic design with lockable castors for use in classrooms, staffrooms and offices. Fitted with a seat tilt to enable movement and correct hip and spine alignment. Inflatable lumbar support to give individual back comfort, right where it is needed. Complies with HSE's "Seating at Work" Guidance and helps employers meet Health and Safety (Display Screen Equipment) Regulations. Suitable for users approx 5'4" and over.

Weight tested 150kg/23 stone. Warranty 5 years. Heavy duty version is available - weight capacity 190kg/30 stone - please contact us for details.

Ergo+ Office Chair	
JB0021	

Jolly Back Teachers Marking Set



1 x Jolly Back Chair + 1 x Pull Up Table + 1 x Ultimate Teachers Trolley

When ordering, please specify chair height.

Teachers Marking Set	
JB0046	

Choice of chair fabric colours



Jolly Back Staff Room Ultimate Bundle



2 x Pull Up Tables + 8 x Posture Rolls + 12 x Maxi Wedges Plus Trolley + 2 x Sit Stand Buddys

Ultimate Staff Room Bundle	
JB0040	

Choice of fabric colours



Jolly Back Staff Room Budget Bundle



1 x Pull Up Table + 8 x Posture Rolls + 12 x Maxi Wedges + 1 x Sit Stand Buddy

Budget Staff Room Bundle	
JB0039	

Choice of fabric colours



Jolly Back Play & Grow Ultimate Bundle



6 x Duo Wedges plus Trolley



1 x Tummy Time Mirror

X2



2 x Bean Wedges

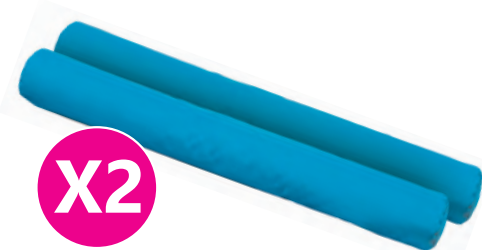

X2

2 x Long Bean Rolls



1 x Large Kneel Friendly Mat Maxi



2 x Sit & Lean Beanbags

X2

Choice of fabric colours

Play & Grow Ultimate Bundle	
JB0042	



Jolly Back Early Years Play & Grow Budget Bundle



1 x Long Bean Roll



1 x Kneel Friendly Mat Midi



1 x Tummy Time Mirror



1 x Duo Wedge



1 x Bean Wedges

Choice of fabric colours

Play & Grow Budget Bundle	
JB0041	



Jolly Back Early Years Floor Play Set



1 x Kneel Friendly Mat Midi



1 x Tummy Time Mirror



1 x Duo Wedge



1 x Portable Posture Roll

Choice of fabric colours

Early Years Floor Play Set	
JB0047	



Jolly Back Early Years Teacher Ultimate Bundle



1 x Jolly Back Chair



X2

2 x Duo Wedges



1 x Teachers Station

X2



2 x Adult Floor Chairs



1 x Floor Table



1 x Kneel Friendly Mat Maxi

When ordering, please specify chair & Teachers Station height.

Early Years Teacher Ultimate Bundle	
JB0036	

Choice of fabric colours



Jolly Back Early Years Teacher Budget Bundle



1 x Long Bean Roll



1 x Kneel Friendly Mat Midi



1 x Sit Stand Buddy



1 x Sit & Lean Beanbag

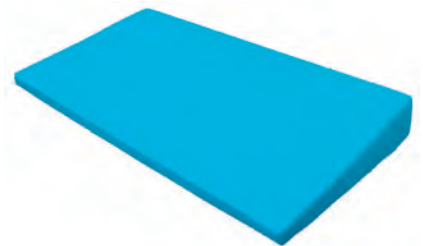

1 x Duo Wedge

Choice of fabric colours

Teacher Budget Bundle	
JB0035	



Jolly Back Teachers Observation Set



Teachers Observation Set	
JB0045	

Jolly Back Primary Teacher Ultimate Bundle



When ordering, please specify chair & Teachers Station height.



Primary Teacher Ultimate Bundle	
JB0038	

Jolly Back Primary Teacher Budget Bundle



When ordering, please specify chair height.

Primary Teacher Budget Bundle	
JB0037	

Jolly Back Story Time Set



12 x Mini Wedges Plus Trolley



2 x Sit & Lean Beanbags

X2

Story Time Set	
JB0048	



Jolly Back Portable Posture Set



12 x Mini Posture Wedges



8 x Posture Rolls



Portable Posture Set	
JB0049	



Jolly Back Primary Years Child Budget Bundle



1 x Storage PostureBench



12 x Mini Posture Wedges



2 x Sit & Lean Beanbags

X2

Primary Years Child Budget Bundle	
JB0043	



Jolly Back Primary Years Child Ultimate Bundle



1 x Storage PostureBench

X4

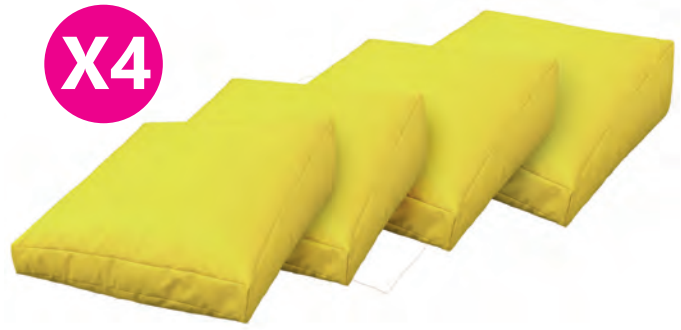

4 x Bean Wedges

X4



4 x Sit & Lean Beanbags



12 x Mini Posture Wedges



Primary Child Ultimate Bundle	
JB0044	



Jolly Back Early Years Group Floor Play Set

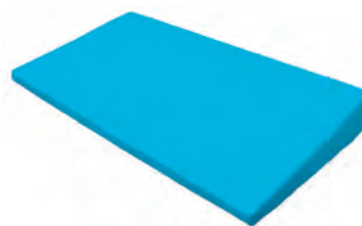

1 x Duo Wedge



1 x Kneel Friendly Mat - Maxi



1 x Long Bean Roll



1 x Bean Wedge



1 x Tummy Time Mirror

Early Years Group Floor Play Set	
JB0050	





Kubbyclass® Library



Willowbrook Education Ltd
Willowbrook House, Quarry Farm Ind. Estate,
Ketton Road, North Luffenham, Stamford, Lincolnshire PE9 3UT
Fax: 01780 721119 - Email: sales@willowbrookeducation.co.uk

Tel: 01780 721115

www.willowbrookeducation.co.uk